

# S32R274RRUEVB AND S32R372RRSEVB QUICK START GUIDE (QSG)

Ultra-Reliable MCUs for Industrial and Automotive Applications

[S32RXXEVB Product Page](#)

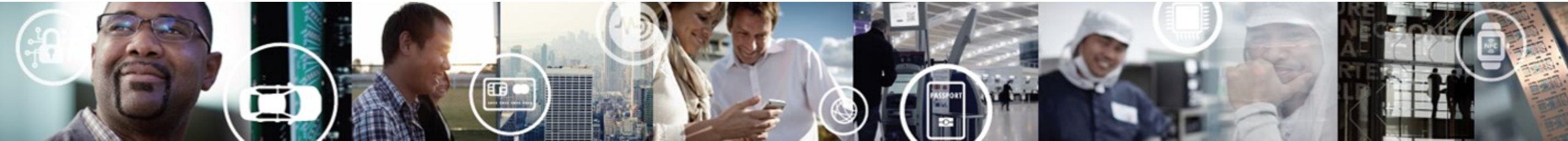

EXTERNAL USE



SECURE CONNECTIONS  
FOR A SMARTER WORLD

# Contents

- [Quick Start Package Overview](#)
- [Step-by-Step Installation Instructions](#)
- [Hardware: S32R274RRUEVB Board](#)
  - [Features](#)
  - [S32R274RRUEVB Overview](#)
  - [How to Read the Schematic](#)
  - [MPC57xxMB Motherboard Overview](#)
  - [S32R274RRUEVB to MPC57xxMB Pinout Settings](#)
  - [Communication and Debug Interfaces](#)
  - [Power Supply](#)
- [Software:](#)
  - [Software Development Tools](#)
  - [Pre-compiled Code Examples](#)
  - [S32R Application Examples](#)
- [Documentation](#)
- [Radar Family Comparison](#)
- [Recommendations](#)



# Quick Start Package Overview

## Board:

S32R274RRUEVB	S32R27/37 evaluation board for 257 BGA package. Can run standalone or with Radar front-end
---------------	--

## Documents:

Name	Description
Quick Start Guide(QSG)	Detailed description on availability of Hardware, Software and Documents to quick start with S32R27/37 project (this document)
Software Installation Guide(SWIG)	Detailed walk through on how to install and use S32 Design Studio for Power Architecture
Application Notes	Detailed documents covering topics from 'how to design hardware' to 'how to write software'
Fact Sheets, Reference Manuals and Data Sheets	Detailed manuals for S32R family of MCU and S32R274RRUEVB board

## Downloads:

Name	Description
Integrated Development Environment (IDE)	Eclipse based S32DS IDE with free GCC compiler and Debugger support
S32R274RRUEVB Quick Start Package	Software examples and supporting documents for getting started with the S32R274RRUEVB
S32R274RRUEVB Schematics	PDF schematic files for the S32R274RRUEVB board
S32R274RRUEVB PCB Design Package	Gerber files and Bill of Material



# Step-by-Step Installation Instructions

In this quick start guide, you will learn how to set up the **S32R274RRUEVB** board and run the default program.

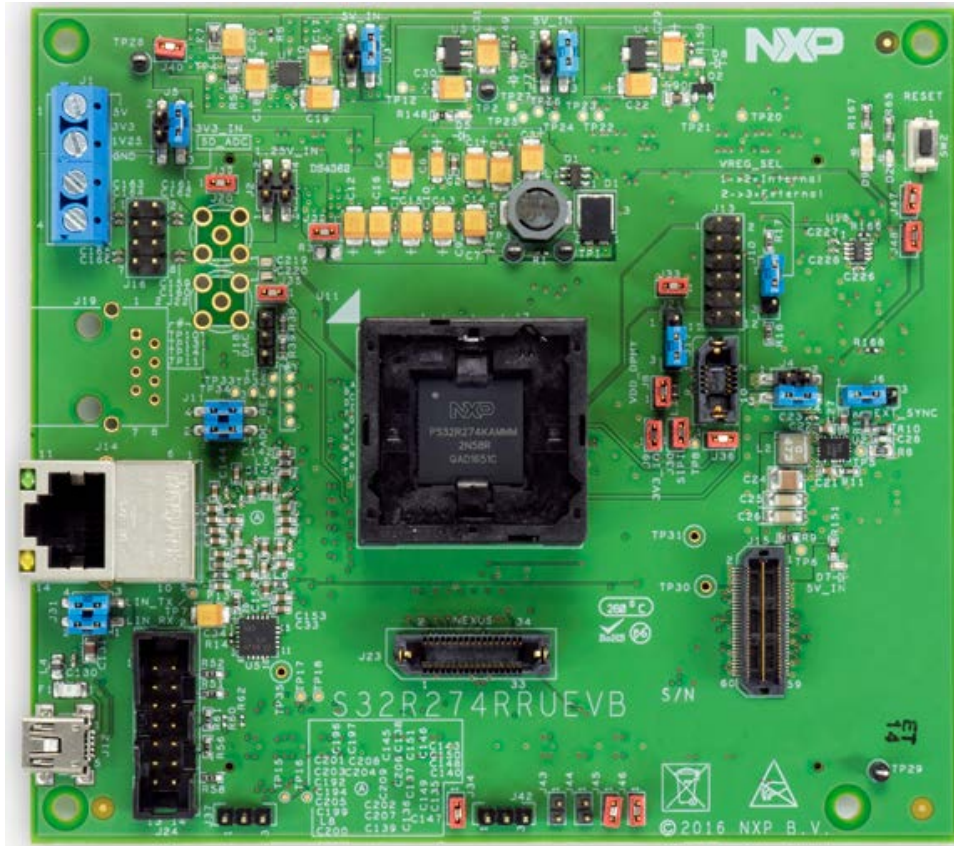

1

## Install Software and Tools

Install S32 Design Studio IDE for Power Architecture.  
[S32 Design Studio for Power](#)  
See Software Installation Guide (SWIG) for detailed procedure

2

## Connect the Debugger

Connect the debugger (e.g. P&E USB Multilink) to the board.

3

## Observe the Default Program reaction

The pre-loaded example project utilizes the **S32R's multiple cores** and the MPC57xxMB's user I/O. Once the board is plugged in, the S32R's PLLs will be programmed to max frequency. The CLKOUT pin will display the frequency of each PLL in a round-robin fashion as each core takes turns controlling CLKOUT.

4

## Learn More About the S32R274RRUEVB

Read release notes and documentation on the  
[S32R Product Page](#)  
[S32R2XXEVB Product Page](#)

# S32R274RRUEVB Board : Features

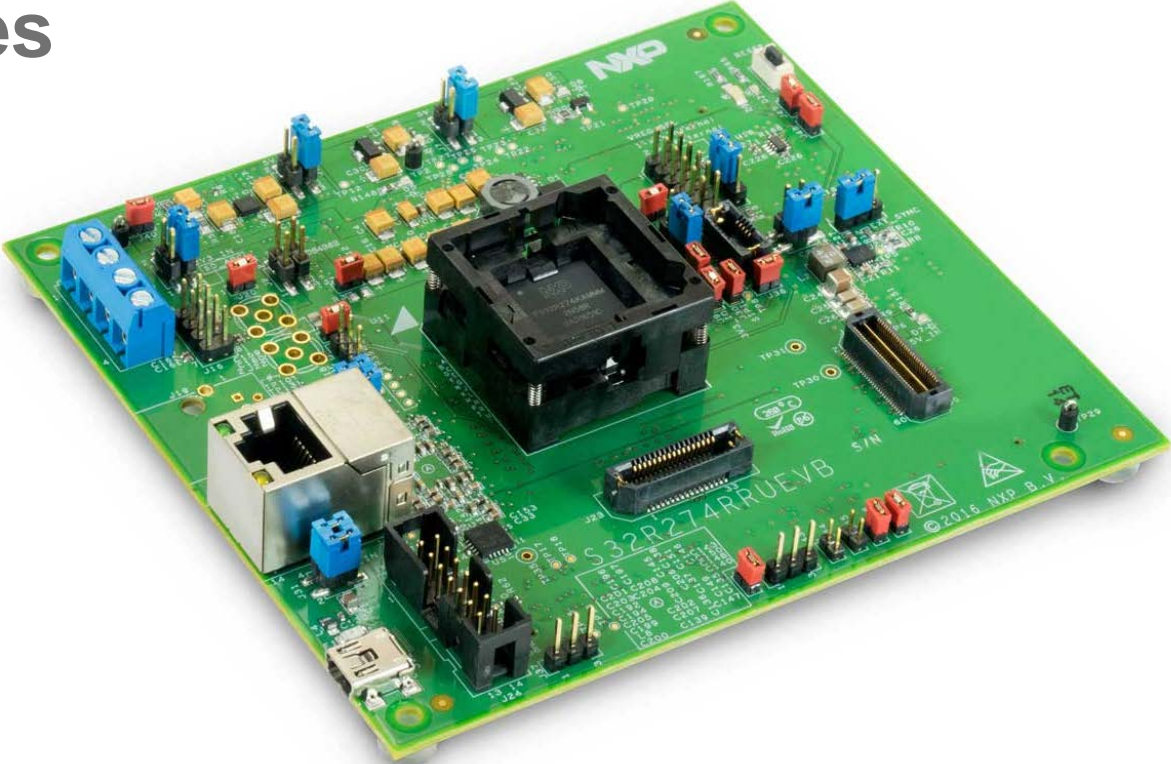
- S32R27 has 2 x 240 MHz Power Architecture® e200Z7 computation cores and 2 x 120 MHz e200z4 delayed lockstep safety cores
  - S32Rx qualified to AEC-Q100 Grade 1 and ambient temperature of -40 to +150 °C
  - S32R274RRUEVB is compatible with MPC57xxMB motherboard for expanded IO functionality
  - Integrated JTAG interface for easy debugging
  - Easy access to the MCU I/O header pins (with motherboard) for prototyping
  - Nexus traceport
  - Gb Ethernet port
  - MIPI\_CSI2 connector
  - Flexible power supply options
    - Individual ports for 5V, 3.3V, and 1.25V power rails
    - 12V External power supply to power all rails via expansion to MPC57xxMB
- 
- The image shows the S32R274RRUEVB development board, a green PCB populated with various components. A large black heat sink is mounted on the central processor. The board features a Gb Ethernet port, a USB port, and several pin headers. The NXP logo is visible in the top right corner, and the board model number 'S32R274RRUEVB' is printed on the PCB. The copyright notice '© 2016 NXP B.V.' is also present.
- Box includes:
    - S32R274RRUEVB Board
  - Downloads includes:
    - Quick Start Package
    - S32 Design Studio IDE
    - Application notes

# S32R274RRUEVB Board : Overview

The S32R274RRUEVB is NXP's evaluation board for the S32R radar processor. It is designed to be paired with an analog front end. NXP supports the TEF810 and MR3003 radar transceivers, but third-party options are possible.

This EVB features expansion headers to the MPC57xxMB motherboard, giving the user access to additional I/O. The motherboard also includes UART, SCI, CAN, and FlexRay ports to meet any prototyping needs.

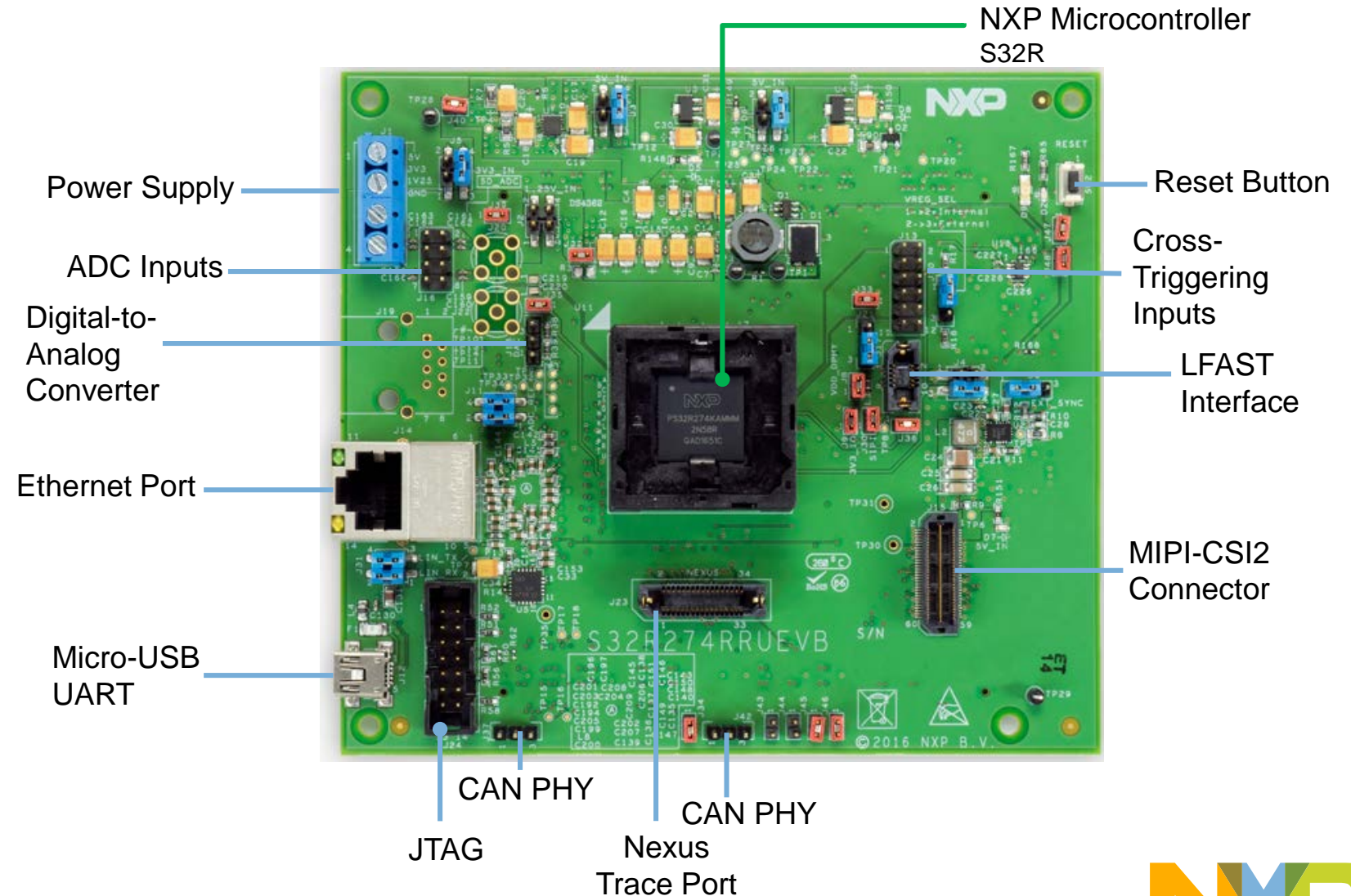

# MPC57xxMB Board : Overview

The MPC57xxMB is NXP's motherboard for the MPC57xx product family as well as S32R274RRUEVB.

Once the S32R274RRUEVB is plugged in, it will have access to all MPC57xxMB I/O. Power can also be provided by the motherboard.

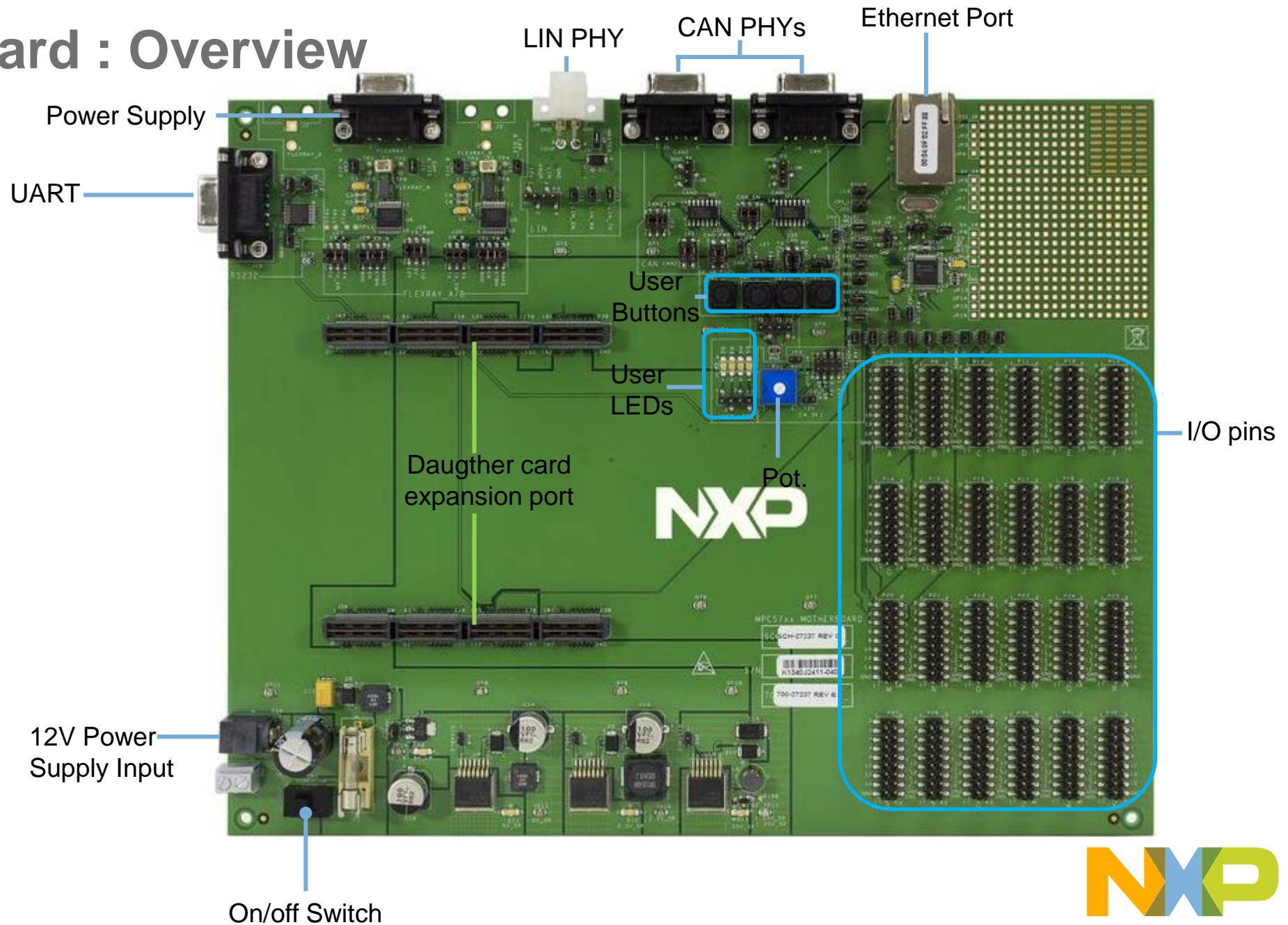

# How to Read the Schematic

- Pin labels on the S32R274RRUEVB schematic map to the physical pad on the 257BGA package, **not** the port number. Use RM's signal description table to find the correct port
- Example: ETIMER2\_ETC0 = PAD(K17) = PORT(PB[2])

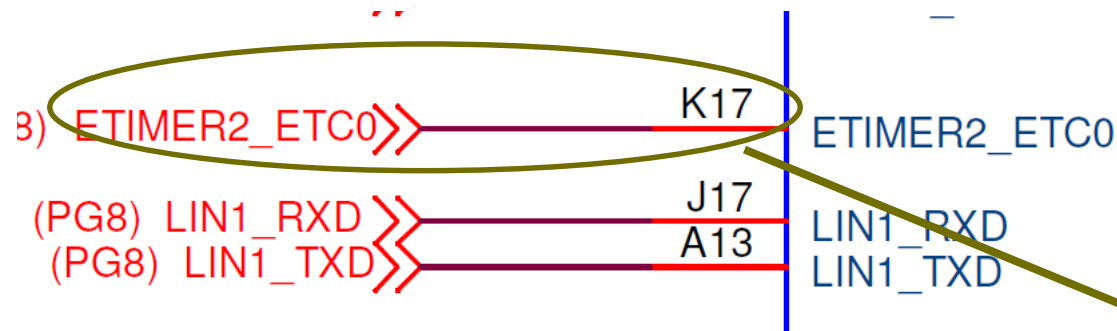

PB[2]	SIUL_MSCR18	0000_0000	GPIO[18]	SIUL	General purpose IO 18	I/O	pad_drv	K17	VDD_HV_IC
		0000_0011	DEBUG2	SSCM	SSCM debug status 2	O			
		0000_0100	SCK	DSPI1	DSPI 1 serial clock out (master)/ in (slave)	O			



# S32R274RRUEVB+MPC57xxMB: Pinout

1 of 12



FUNCTION	PORT	PIN
WGM_WG0	PA0	P8-1
WGM_WG2_P	PA2	P8-3
DSPI2_CS1	PA4	P8-5
	NC	P8-7
	NC	P8-9
DSPI2_CS0	PA10	P8-11
DSPI2_SOUT	PA12	P8-13
CAN1_TXD	PA14	P8-15
	GND	GND

P8



PIN	PORT	FUNCTION
P8-2	PA1	WGM_WG1
P8-4	PA3	WGM_WG2_N
P8-6	PA5	SIUL_EIRQ5
P8-8	NC	
P8-10	PA9	
P8-12	PA11	DSPI2_SCK
P8-14	PA13	DSPI2_SIN
P8-16	PB1	CAN1_RXD
GND	GND	

FUNCTION	PORT	PIN
	NC	P9-1
eTimer2_ETC0	PB2	P9-3
	NC	P9-5
CLK_OUT0	PB6	P9-7
ADC0_AN_1	PB8	P9-9
ADC0_AN_12	PB10	P9-11
ADC0_AN_14	PB12	P9-13
ADC1_AN_1	PB14	P9-15
	GND	GND

P9

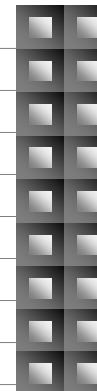

PIN	PORT	FUNCTION
P9-2	NC	
P9-4	PB3	
P9-6	NC	
P9-8	PB7	ADC0_AN_0
P9-10	PB9	ADC0_AN_11
P9-12	PB11	ADC0_AN_13
P9-14	PB13	ADC1_AN_0
P9-16	PB15	ADC1_AN_2
GND	GND	

# S32R274RRUEVB+MPC57xxMB: Pinout

2 of 12

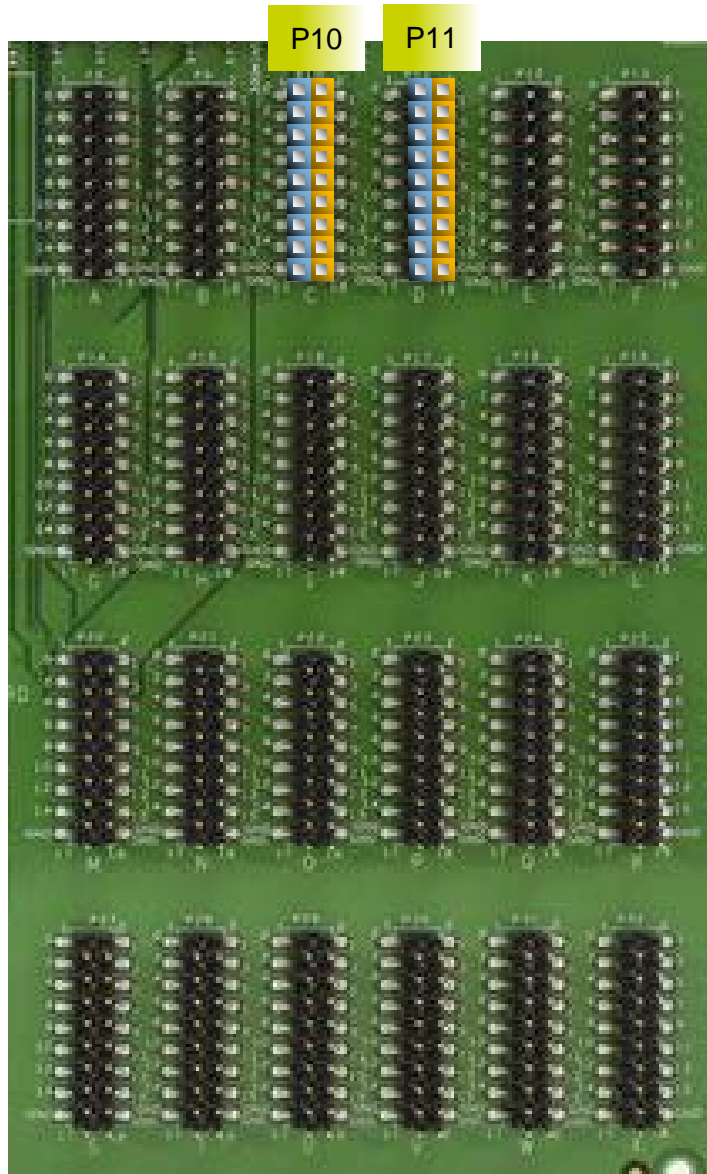

FUNCTION	PORT	PIN
ADC1_AN_3	PC0	P10-1
ADC0_AN_3	PC2	P10-3
TP17	PC4	P10-5
TP18	PC6	P10-7
MB_CAN0_RXD	PA15 (DNP)	P10-9
	NC	P10-11
	NC	P10-13
	NC	P10-15
	GND	GND

P10



PIN	PORT	FUNCTION
P10-2	PC1	ADC0_AN_2
P10-4	NC	
P10-6	PC5	TP15
P10-8	PC7	TP16
P10-10	PB0 (DNP)	MB_CAN0_TXD
P10-12	NC	
P10-14	PC15 (DNP)	RGMII_TX_EN
P10-16	NC	
GND	GND	

FUNCTION	PORT	PIN
FLEX_TXD_A_PDO	PD0 (DNP)	P11-1
	NC	P11-3
	NC	P11-5
	PD6 (DNP)	P11-7
WGM_WG3_P	PD8	P11-9
	DNC	P11-11
CTU0_EXT_TRIG	PD14	P11-13
LIN1_TXD	PD11	P11-15
	GND	GND

P11

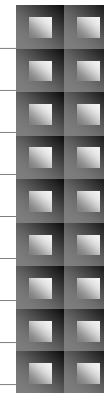

PIN	PORT	FUNCTION
P11-2	NC	
P11-4	NC	
P11-6	PD5 (DNP)	RGMII_RX_D0
P11-8	NC	TP20 (EVB test pt)
P11-10	NC	
P11-12	NC	
P11-14	NC	
P11-16	PF15	LIN1_RXD
GND	GND	

Note: “DNP” stands for “Do not populate”, meaning pin is disconnected by default. You must solder a resistor across the appropriate resistor slot on S32R274RRUEVB to enable the function.



# S32R274RRUEVB+MPC57xxMB: Pinout

3 of 12

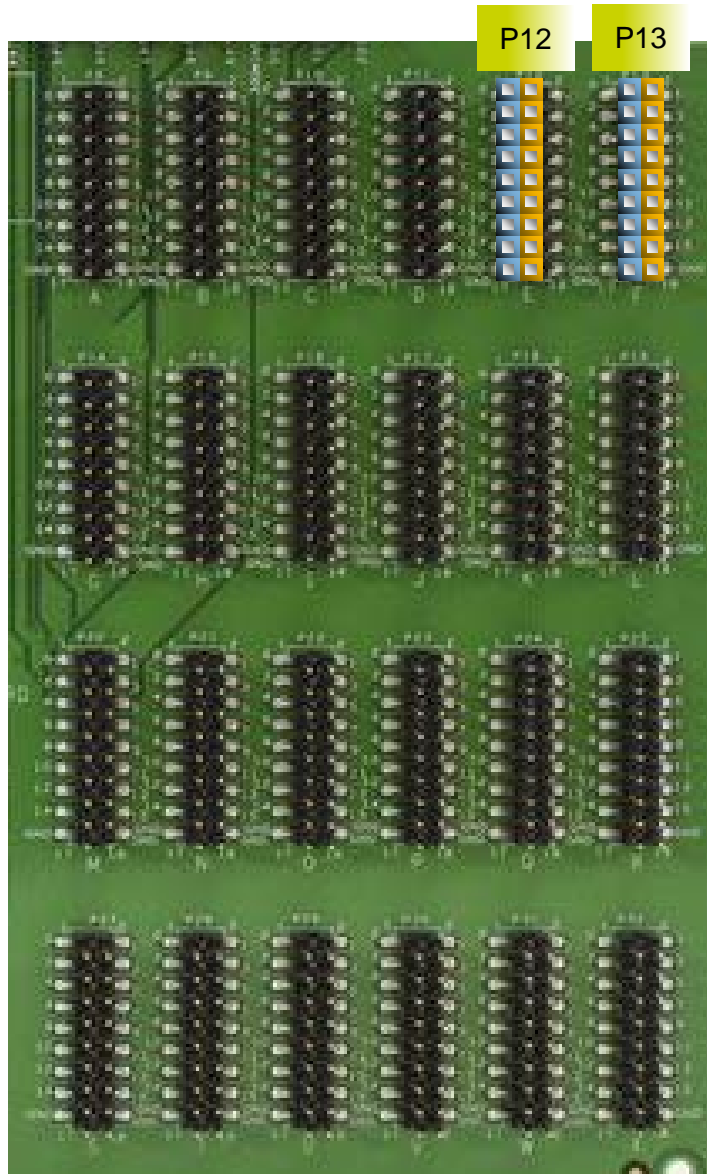

FUNCTION	PORT	PIN
	NC	<b>P12-1</b>
ADC0_AN_5	PE2	<b>P12-3</b>
ADC0_AN_7	PE4	<b>P12-5</b>
ADC0_AN_4	PE6	<b>P12-7</b>
	NC	<b>P12-9</b>
	NC	<b>P12-11</b>
	NC	<b>P12-13</b>
	NC	<b>P12-15</b>
	GND	<b>GND</b>

P12



PIN	PORT	FUNCTION
<b>P12-2</b>	NC	
<b>P12-4</b>	NC	
<b>P12-6</b>	PE5	ADC0_AN_8
<b>P12-8</b>	PE7	ADC0_AN_6
<b>P12-10</b>	NC	
<b>P12-12</b>	NC	
<b>P12-14</b>	NC	
<b>P12-16</b>	PE15	GPIO_PE15
<b>GND</b>	GND	

FUNCTION	PORT	PIN
	NC	<b>P13-1</b>
	NC	<b>P13-3</b>
	NC	<b>P13-5</b>
	NC	<b>P13-7</b>
	NC	<b>P13-9</b>
	NC	<b>P13-11</b>
	NC	<b>P13-13</b>
	NC	<b>P13-15</b>
	GND	<b>GND</b>

P13



PIN	PORT	FUNCTION
<b>P13-2</b>	NC	
<b>P13-4</b>	NC	
<b>P13-6</b>	NC	
<b>P13-8</b>	NC	
<b>P13-10</b>	NC	
<b>P13-12</b>	NC	
<b>P13-14</b>	NC	TP21 (EVB test pt)
<b>P13-16</b>	NC	
<b>GND</b>	GND	

Note: “DNP” stands for “Do not populate”, meaning pin is disconnected by default. You must solder a resistor across the appropriate resistor slot on S32R274RRUEVB to enable the function.



# S32R274RRUEVB+MPC57xxMB: Pinout

4 of 12

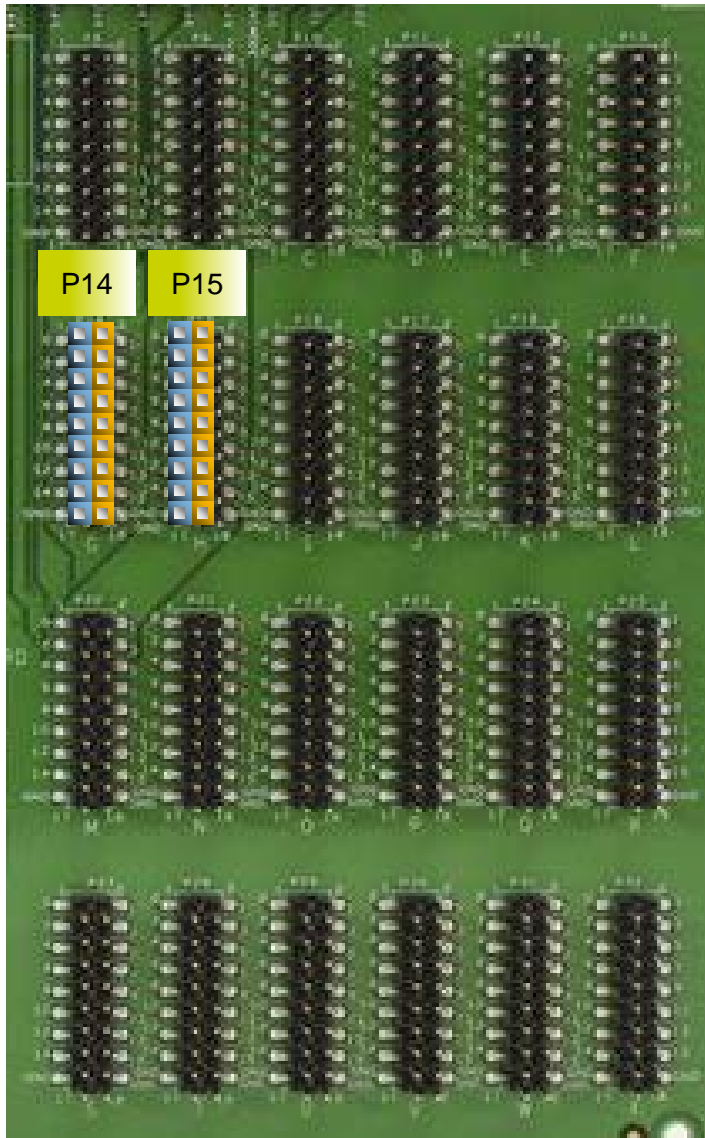

FUNCTION	PORT	PIN
FCCU_F_0	FCCU[F0]	P14-1
NMI	NMI	P14-3
	NC	P14-5
	NC	P14-7
MDIO	PG8 (DNP)	P14-9
RGMII_TX_D3	PG10 (DNP)	P14-11
	NC	P14-13
	NC	P14-15
	GND	GND

P14



PIN	PORT	FUNCTION
P14-2	FCCU[F1]	FCCU_F_1
P14-4	NC	
P14-6	NC	
P14-8	NC	
P14-10	PG9 (DNP)	MDC
P14-12	PG11 (DNP)	RGMII_TXCLK
P14-14	NC	
P14-16	NC	
GND	GND	

FUNCTION	PORT	PIN
RGMII_RX_D2	PH4 (DNP)	P15-1
	NC	P15-3
FLEX_TXEN_B	PD4 (DNP)	P15-5
	NC	P15-7
FLEX_TXEN_A	PI5	P15-9
FLEX_CB_RX	PD2 (DNP)	P15-11
	NC	P15-13
	NC	P15-15
	GND	GND

P15



PIN	PORT	FUNCTION
P15-2	NC	
P15-4	PD3 (DNP)	FLEX_TXD_B
P15-6	NC	
P15-8	PI6	FLEX_TXD_A
P15-10	PD1	FLEX_CA_RX
P15-12	NC	
P15-14	PH13 (DNP)	RGMII_RX_CLK
P15-16	NC	
GND	GND	

Note: “DNP” stands for “Do not populate”, meaning pin is disconnected by default. You must solder a resistor across the appropriate resistor slot on S32R274RRUEVB to enable the function.



# S32R274RRUEVB+MPC57xxMB: Pinout

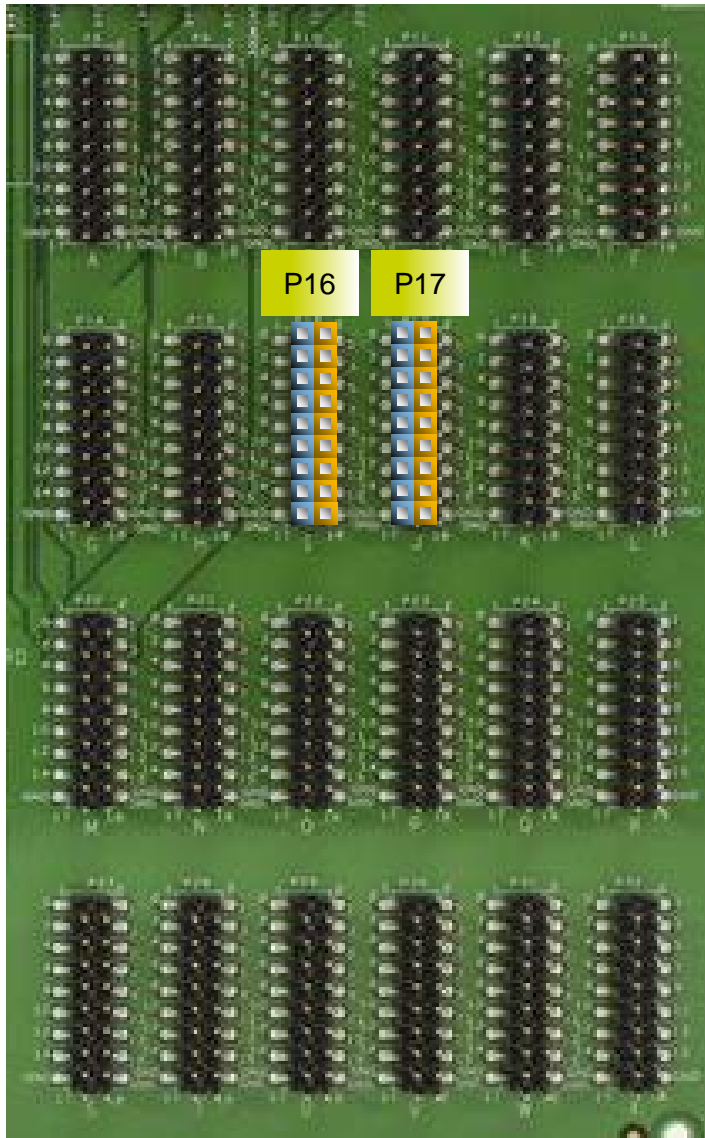

FUNCTION	PORT	PIN
	NC	<b>P16-1</b>
GPIO_PI2	PI2 (DNP)	<b>P16-3</b>
	NC	<b>P16-5</b>
	NC	<b>P16-7</b>
	NC	<b>P16-9</b>
	NC	<b>P16-11</b>
	NC	<b>P16-13</b>
	NC	<b>P16-15</b>
	GND	<b>GND</b>

P16



PIN	PORT	FUNCTION
<b>P16-2</b>	PI1	GPIO_PI1
<b>P16-4</b>	NC	
<b>P16-6</b>	NC	
<b>P16-8</b>	NC	
<b>P16-10</b>	NC	
<b>P16-12</b>	NC	
<b>P16-14</b>	NC	
<b>P16-16</b>	NC	
<b>GND</b>	GND	

FUNCTION	PORT	PIN
GPIO_PH6	PH6	<b>P17-1</b>
I2C1_DATA	PH8	<b>P17-3</b>
	NC	<b>P17-5</b>
	NC	<b>P17-7</b>
	NC	<b>P17-9</b>
	NC	<b>P17-11</b>
	NC	<b>P17-13</b>
	NC	<b>P17-15</b>
	GND	<b>GND</b>

P17



PIN	PORT	FUNCTION
<b>P17-2</b>	PH7	I2C1_CLK
<b>P17-4</b>	PH9	GPIO_PH9
<b>P17-6</b>	NC	TP22 (EVB test pt)
<b>P17-8</b>	NC	TP23 (EVB test pt)
<b>P17-10</b>	NC	
<b>P17-12</b>	NC	
<b>P17-14</b>	NC	
<b>P17-16</b>	NC	
<b>GND</b>	GND	

Note: “DNP” stands for “Do not populate”, meaning pin is disconnected by default. You must solder a resistor across the appropriate resistor slot on S32R274RRUEVB to enable the function.



# S32R274RRUEVB+MPC57xxMB: Pinout

6 of 12

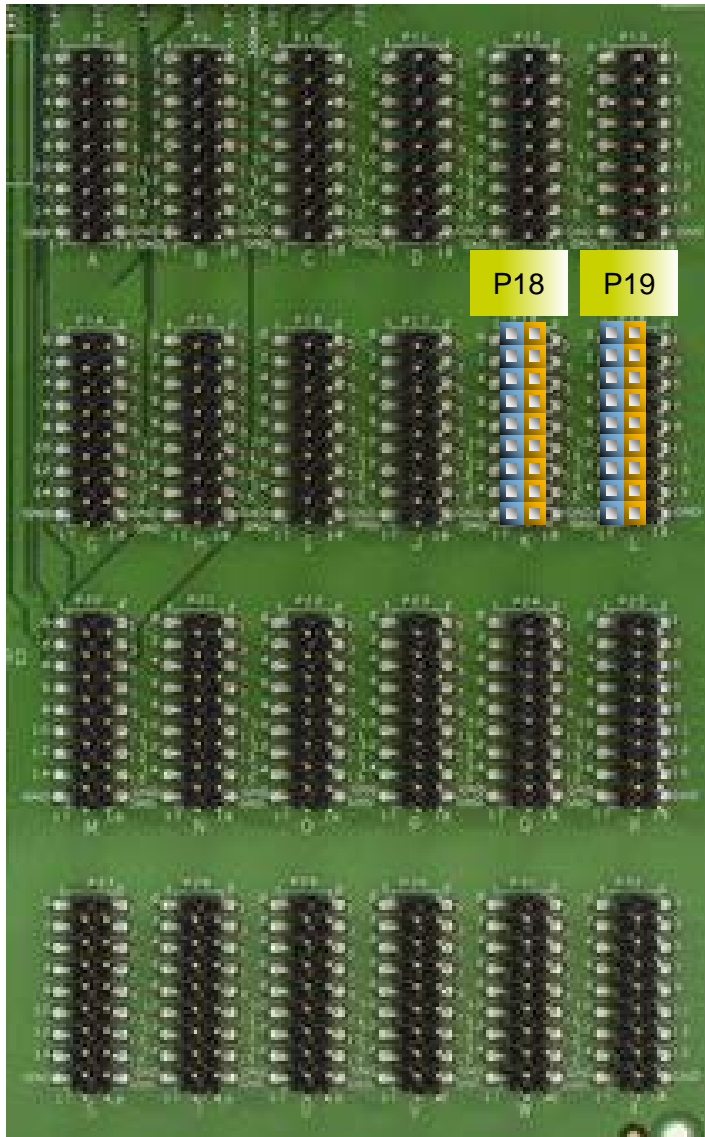

FUNCTION	PORT	PIN
	NC	P18-1
	NC	P18-3
	NC	P18-5
	NC	P18-7
	NC	P18-9
	NC	P18-11
	NC	P18-13
	NC	P18-15
	GND	GND

P18



PIN	PORT	FUNCTION
P18-2	NC	
P18-4	NC	
P18-6	NC	
P18-8	NC	
P18-10	NC	
P18-12	NC	
P18-14	NC	
P18-16	NC	
GND	GND	

FUNCTION	PORT	PIN
	NC	P19-1
	NC	P19-3
	NC	P19-5
	NC	P19-7
	NC	P19-9
	NC	P19-11
	NC	P19-13
	NC	P19-15
	GND	GND

P19



PIN	PORT	FUNCTION
P19-2	NC	
P19-4	NC	
P19-6	NC	
P19-8	NC	
P19-10	NC	TP24 (EVB test pt)
P19-12	NC	TP25 (EVB test pt)
P19-14	NC	TP26 (EVB test pt)
P19-16	NC	TP27 (EVB test pt)
GND	GND	

Note: “DNP” stands for “Do not populate”, meaning pin is disconnected by default. You must solder a resistor across the appropriate resistor slot on S32R274RRUEVB to enable the function.



# S32R274RRUEVB+MPC57xxMB: Pinout

7 of 12

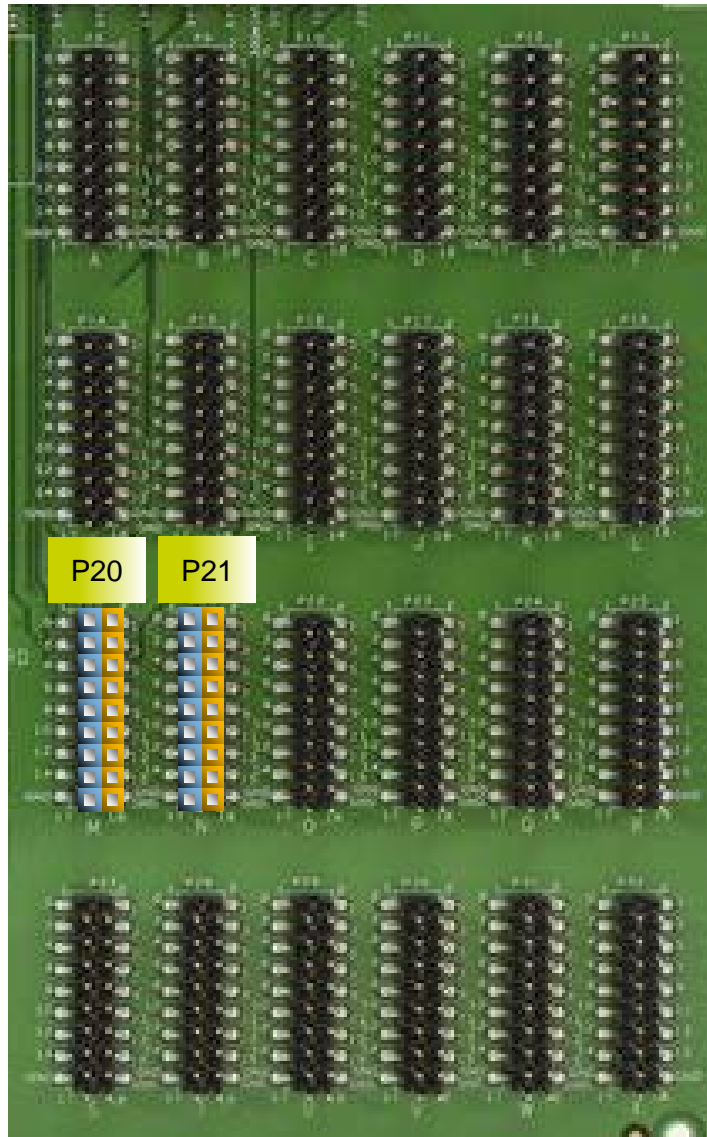

FUNCTION	PORT	PIN
	NC	P20-1
	NC	P20-3
	NC	P20-5
	NC	P20-7
	NC	P20-9
	NC	P20-11
	NC	P20-13
	NC	P20-15
	GND	GND

P20



PIN	PORT	FUNCTION
P20-2	NC	
P20-4	NC	
P20-6	NC	
P20-8	NC	
P20-10	NC	
P20-12	NC	
P20-14	NC	
P20-16	NC	
GND	GND	

FUNCTION	PORT	PIN
	NC	P21-1
	NC	P21-3
	NC	P21-5
	NC	P21-7
	NC	P21-9
	NC	P21-11
	NC	P21-13
	NC	P21-15
	GND	GND

P21

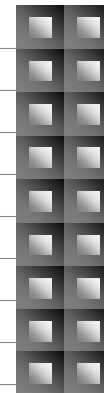

PIN	PORT	FUNCTION
P21-2	NC	
P21-4	NC	
P21-6	NC	
P21-8	NC	
P21-10	NC	
P21-12	NC	
P21-14	NC	
P21-16	NC	
GND	GND	

Note: “DNP” stands for “Do not populate”, meaning pin is disconnected by default. You must solder a resistor across the appropriate resistor slot on S32R274RRUEVB to enable the function.



# S32R274RRUEVB+MPC57xxMB: Pinout

8 of 12

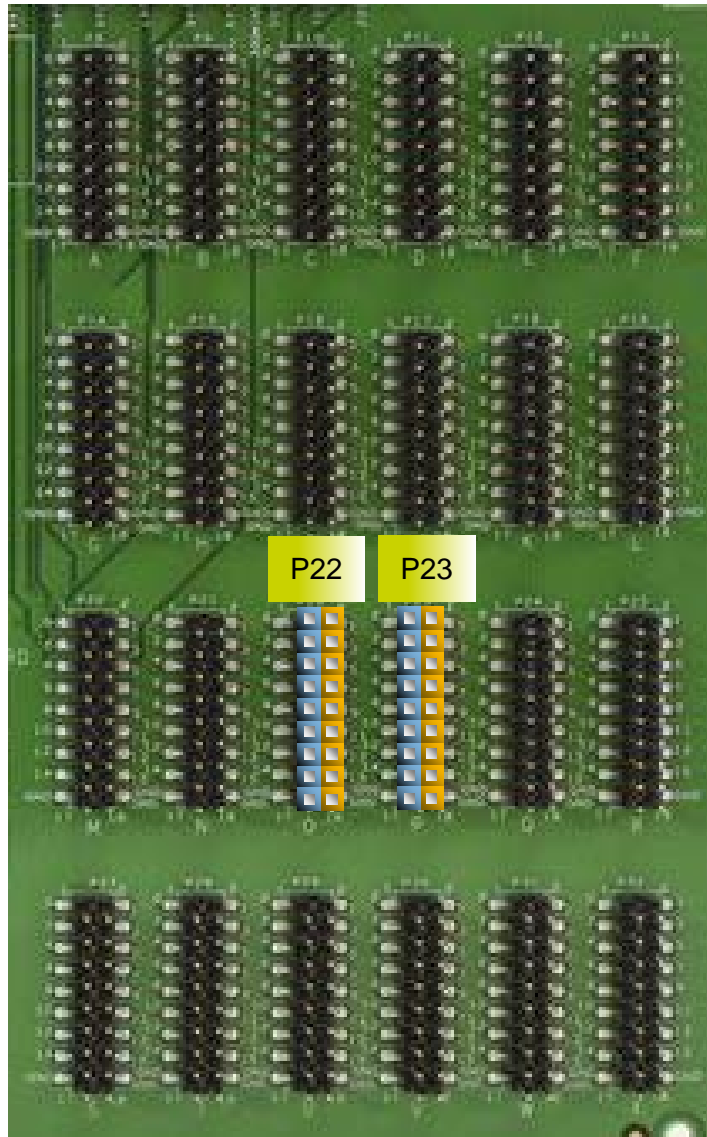

FUNCTION	PORT	PIN
	NC	P22-1
	NC	P22-3
	NC	P22-5
	NC	P22-7
	NC	P22-9
	NC	P22-11
	NC	P22-13
	NC	P22-15
	GND	GND

P22



PIN	PORT	FUNCTION
P22-2	NC	
P22-4	NC	
P22-6	NC	
P22-8	NC	
P22-10	NC	
P22-12	NC	
P22-14	NC	
P22-16	NC	
GND	GND	

FUNCTION	PORT	PIN
	NC	P23-1
	NC	P23-3
	NC	P23-5
	NC	P23-7
	NC	P23-9
	NC	P23-11
	NC	P23-13
	NC	P23-15
	GND	GND

P23

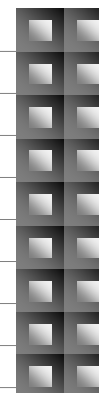

PIN	PORT	FUNCTION
P23-2	NC	
P23-4	NC	
P23-6	NC	
P23-8	NC	
P23-10	NC	
P23-12	NC	
P23-14	NC	
P23-16	NC	
GND	GND	

Note: “DNP” stands for “Do not populate”, meaning pin is disconnected by default. You must solder a resistor across the appropriate resistor slot on S32R274RRUEVB to enable the function.





# S32R274RRUEVB+MPC57xxMB: Pinout

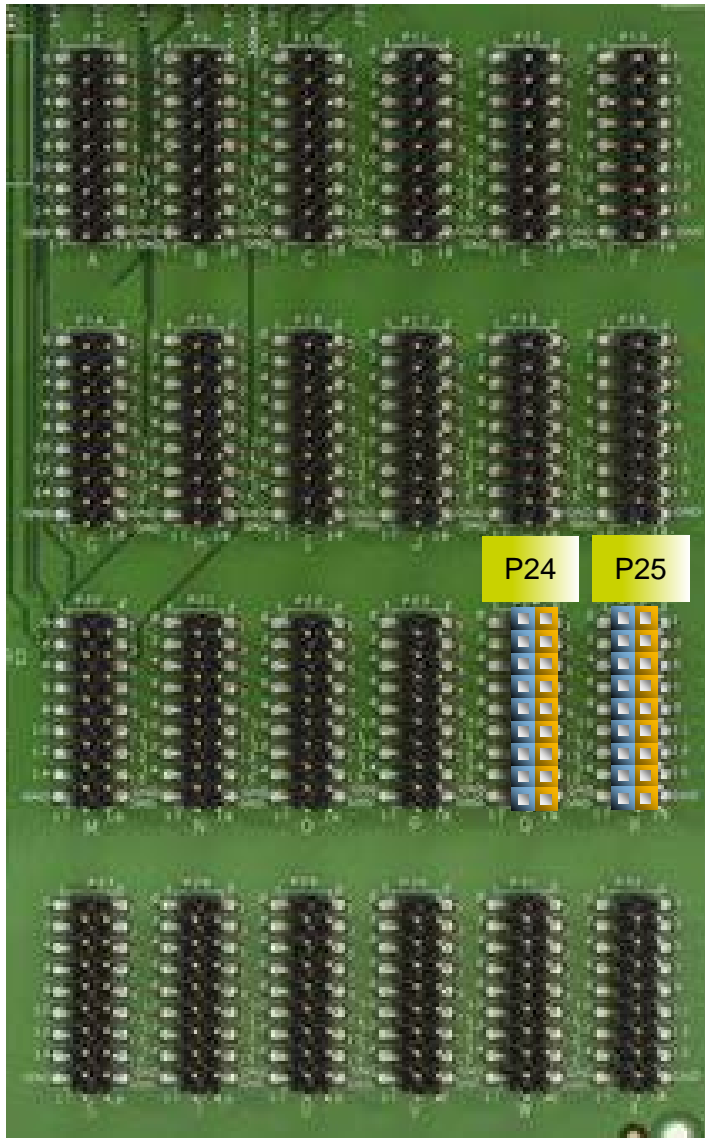

P24 P25

FUNCTION	PORT	PIN
	NC	P24-1
	NC	P24-3
	NC	P24-5
	NC	P24-7
	NC	P24-9
	NC	P24-11
	NC	P24-13
	NC	P24-15
	GND	GND

P24



PIN	PORT	FUNCTION
P24-2	NC	
P24-4	NC	
P24-6	NC	
P24-8	NC	
P24-10	NC	
P24-12	NC	
P24-14	NC	
P24-16	NC	
GND	GND	

FUNCTION	PORT	PIN
	NC	P25-1
	NC	P25-3
	NC	P25-5
	NC	P25-7
	NC	P25-9
	NC	P25-11
	NC	P25-13
	NC	P25-15
	GND	GND

P25

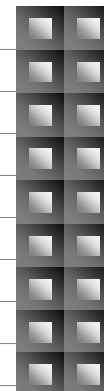

PIN	PORT	FUNCTION
P25-2	NC	
P25-4	NC	
P25-6	NC	
P25-8	NC	
P25-10	NC	
P25-12	NC	
P25-14	NC	
P25-16	NC	
GND	GND	

Note: “DNP” stands for “Do not populate”, meaning pin is disconnected by default. You must solder a resistor across the appropriate resistor slot on S32R274RRUEVB to enable the function.



# S32R274RRUEVB+MPC57xxMB: Pinout

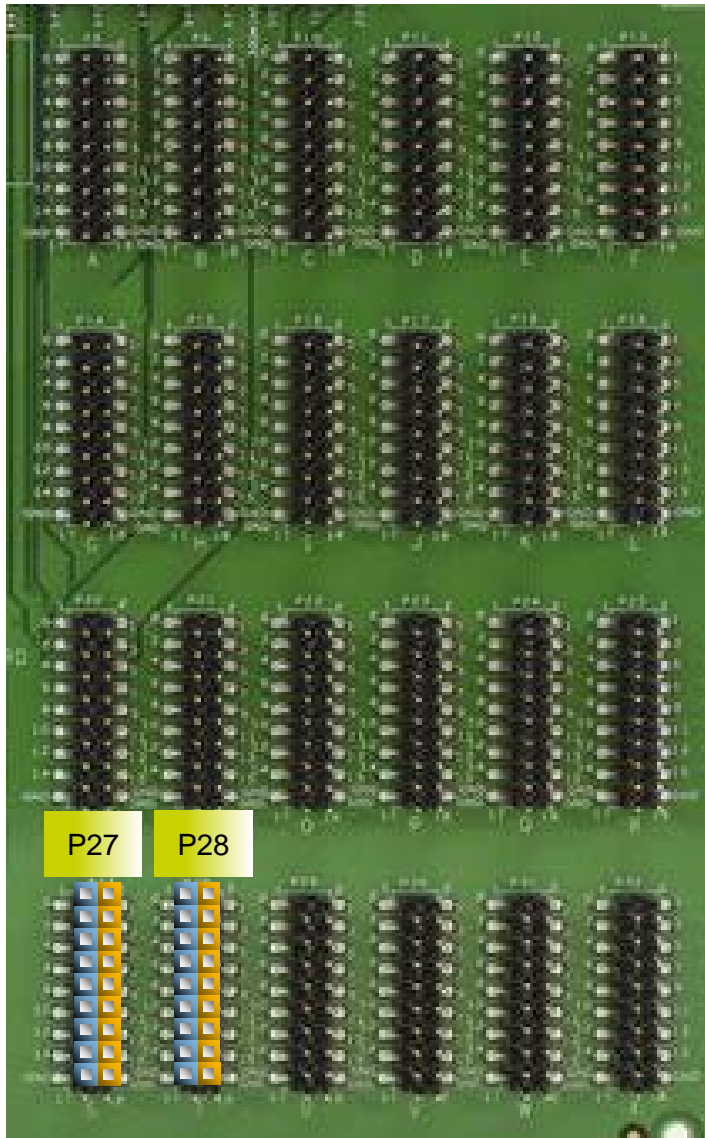

FUNCTION	PORT	PIN
	NC	P27-1
	NC	P27-3
	NC	P27-5
	NC	P27-7
	NC	P27-9
	NC	P27-11
	NC	P27-13
	NC	P27-15
	GND	GND

P27



PIN	PORT	FUNCTION
P27-2	NC	
P27-4	NC	
P27-6	NC	
P27-8	NC	
P27-10	NC	
P27-12	NC	
P27-14	NC	
P27-16	NC	
GND	GND	

FUNCTION	PORT	PIN
	NC	P28-1
	NC	P28-3
	NC	P28-5
	NC	P28-7
	NC	P28-9
	NC	P28-11
	NC	P28-13
	NC	P28-15
	GND	GND

P28



PIN	PORT	FUNCTION
P28-2	NC	
P28-4	NC	
P28-6	NC	
P28-8	NC	
P28-10	NC	
P28-12	NC	
P28-14	NC	
P28-16	NC	
GND	GND	

Note: “DNP” stands for “Do not populate”, meaning pin is disconnected by default. You must solder a resistor across the appropriate resistor slot on S32R274RRUEVB to enable the function.



# S32R274RRUEVB+MPC57xxMB: Pinout

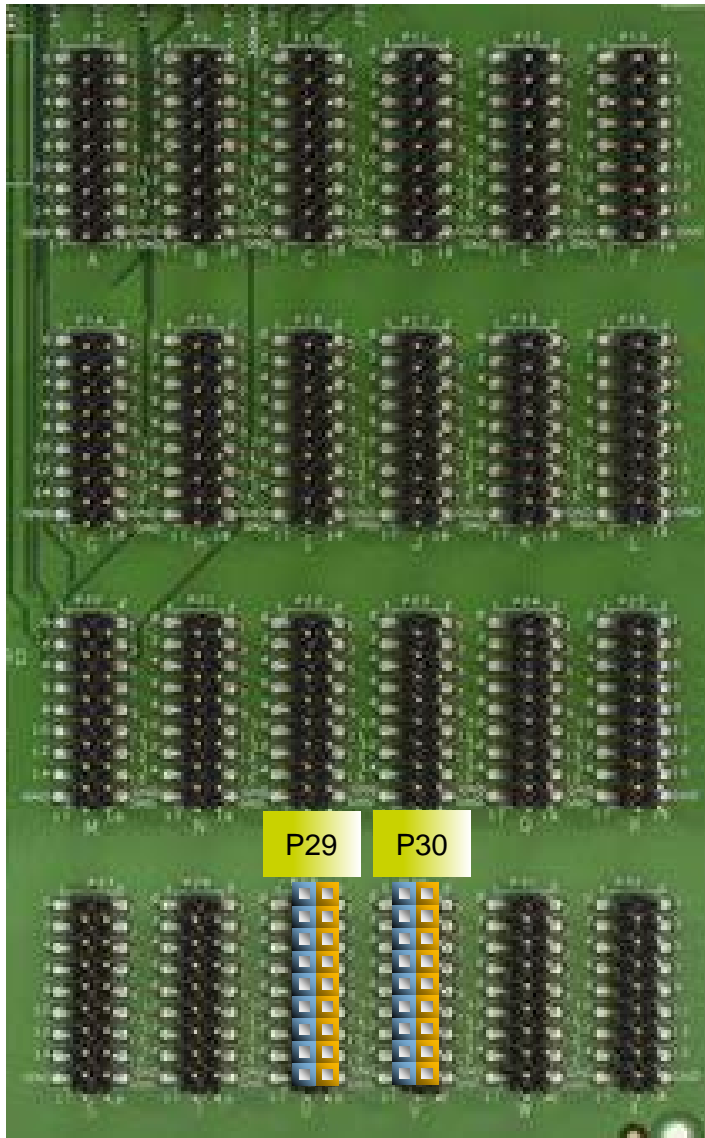

FUNCTION	PORT	PIN
	NC	P29-1
	NC	P29-3
	NC	P29-5
	NC	P29-7
	NC	P29-9
	NC	P29-11
	NC	P29-13
	NC	P29-15
	GND	GND

P29



PIN	PORT	FUNCTION
P29-2	NC	
P29-4	NC	
P29-6	NC	
P29-8	NC	
P29-10	NC	
P29-12	NC	
P29-14	NC	
P29-16	NC	
GND	GND	

FUNCTION	PORT	PIN
	NC	P30-1
	NC	P30-3
	NC	P30-5
	NC	P30-7
	NC	P30-9
	NC	P30-11
	NC	P30-13
	NC	P30-15
	GND	GND

P30



PIN	PORT	FUNCTION
P30-2	NC	
P30-4	NC	
P30-6	NC	
P30-8	NC	
P30-10	NC	
P30-12	NC	
P30-14	NC	
P30-16	NC	
GND	GND	

Note: “DNP” stands for “Do not populate”, meaning pin is disconnected by default. You must solder a resistor across the appropriate resistor slot on S32R274RRUEVB to enable the function.



# S32R274RRUEVB+MPC57xxMB: Pinout

12 of 12

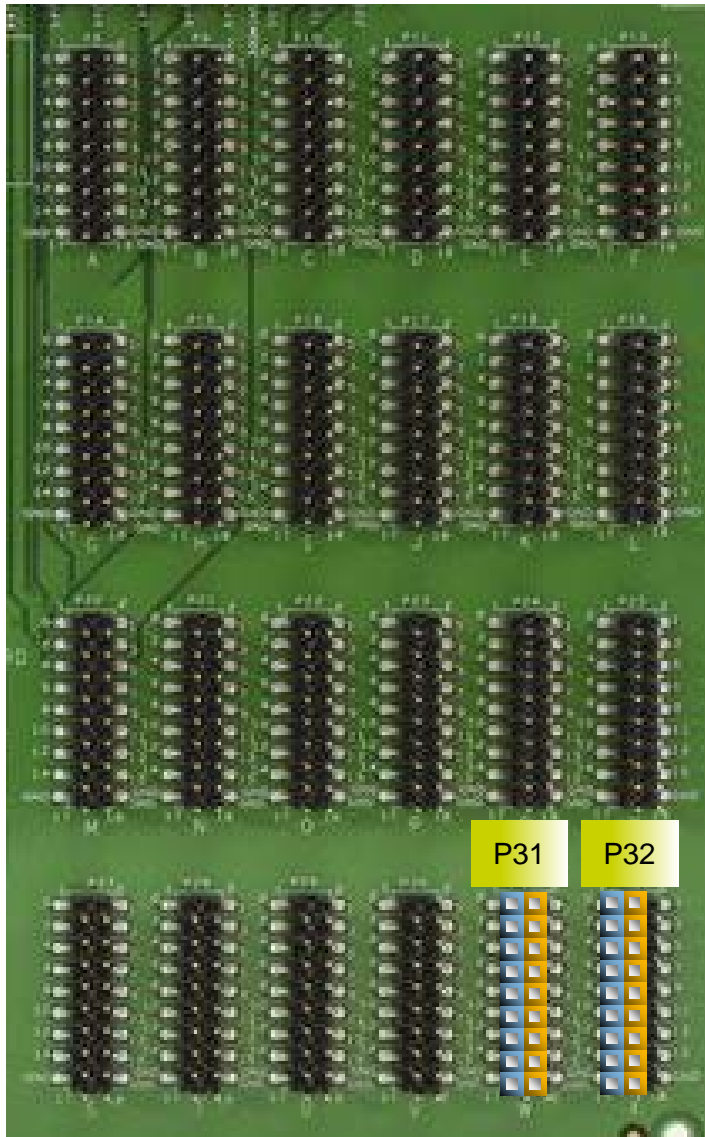

FUNCTION	PORT	PIN
	NC	P31-1
	NC	P31-3
	NC	P31-5
	NC	P31-7
	NC	P31-9
	NC	P31-11
	NC	P31-13
	NC	P31-15
	GND	GND

P31

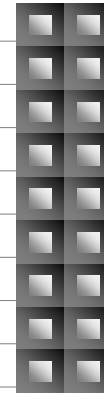

PIN	PORT	FUNCTION
P31-2	NC	
P31-4	NC	
P31-6	NC	
P31-8	NC	
P31-10	NC	
P31-12	NC	
P31-14	NC	
P31-16	NC	
GND	GND	

FUNCTION	PORT	PIN
	NC	P32-1
	NC	P32-3
	NC	P32-5
	NC	P32-7
	NC	P32-9
	NC	P32-11
	NC	P32-13
	NC	P32-15
	GND	GND

P32



PIN	PORT	FUNCTION
P32-2	NC	
P32-4	NC	
P32-6	NC	
P32-8	NC	
P32-10	NC	
P32-12	NC	
P32-14	NC	
P32-16	NC	
GND	GND	

Note: “DNP” stands for “Do not populate”, meaning pin is disconnected by default. You must solder a resistor across the appropriate resistor slot on S32R274RRUEVB to enable the function.



# S32R274RRUEVB: Communication Interfaces

1 of 2

UART1

DESCRIPTION	PORT
LIN1_RXD	PF15
LIN1_TXD	PD11

UART1

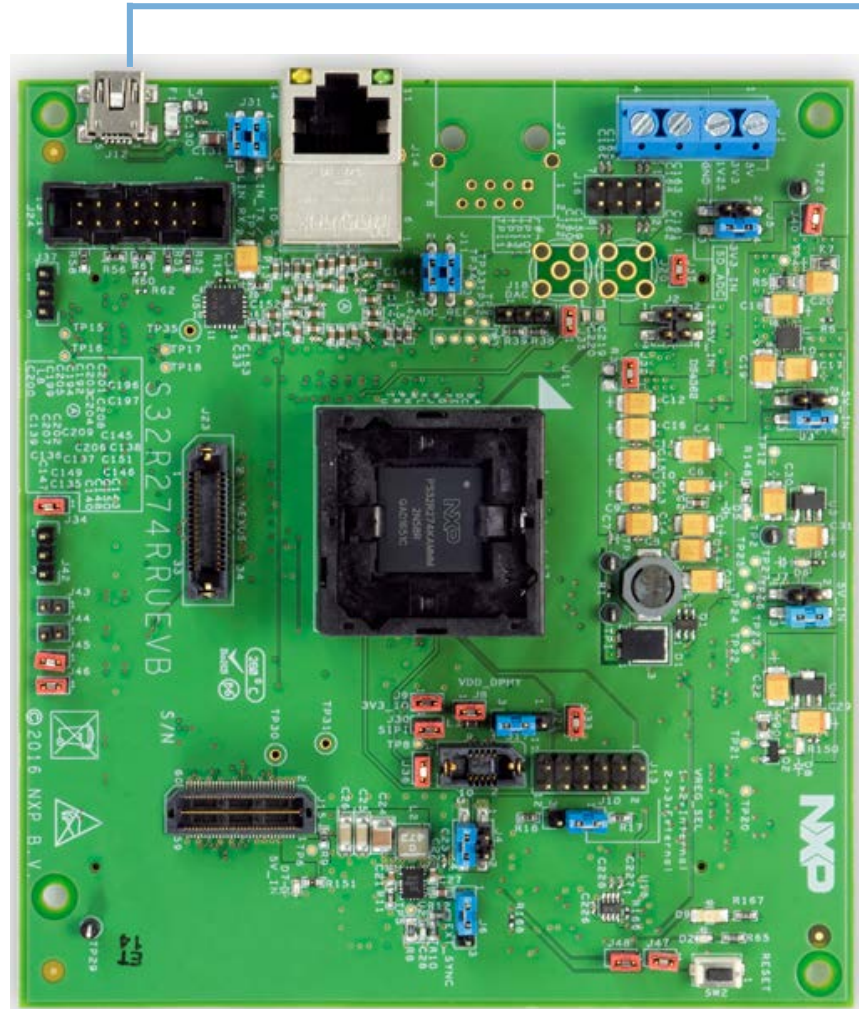

CAN\_0

DESCRIPTION	NAME	PIN
Port PA15 & PB0	CANH	J37-01
	CANL	J37-02
	GND	J37-03



CAN0

CAN\_2

DESCRIPTION	NAME	PIN
Port PI5 & PI6	CANH	J42-01
	CANL	J42-02
	GND	J42-03



CAN2



# S32R274RRUEVB: Communication Interfaces

2 of 2

## Ethernet

DESCRIPTION	PORT
RGMII_TXCLK	PG11
RGMII_TX_D0	PD0
RGMII_TX_D1	PD3
RGMII_TX_D2	PD4
RGMII_TX_D3	PG10
RGMII_TX_EN	PC15
RGMII_RX_CLK	PH13
RGMII_RX_D0	PD5
RGMII_RX_D1	PD6
RGMII_RX_D2	PH4
RGMII_RX_D3	PH5
RGMII_RX_DV	PD2
RESET_B*	RESET_B
ENET_REF_CLK	PI2
MDC	PG9
MDIO	PG8

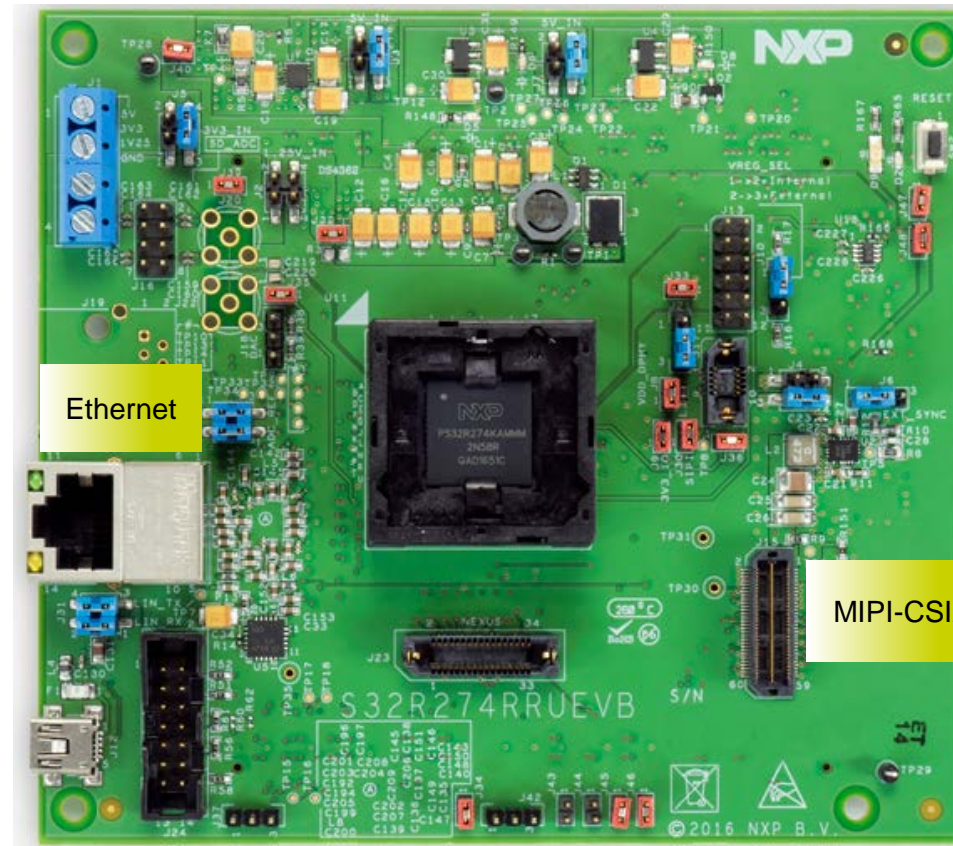

## MIPI-CSI2

DESCRIPTION	PORT
ETIMER2_ETC3	PC12
SD_0_ADCN*	SDADC0 Neg. Inp.
SD_0_ADCP*	SDADC0 Pos. Inp.
CTE_RFS	PE13
DSPI2_SOUT	PA12
DSPI2_SIN	PA13
DSPI2_CS0	PA10
DSPI2_SCK	PA11
SIUL_EIRQ5	PA5
MCU_CLK_P*	XOSC_XTAL (DNP)
MCU_CLK_N*	XOSC_EXTAL (DNP)
ETIMER2_ETC0	PB2
MCU_CLK_SE*	XOSC_EXTAL (DNP)
ADCO_AN_0	PB7
RESET_B*	RESET_B
CTE_RCS	PF0
CSI_LANE2N*	Lane2 Neg. Inp.
CSI_LANE2P*	Lane2 Pos. Inp.
CSI_LANE0P*	Lane0 Neg. Inp.
CSI_LANE0N*	Lane0 Pos. Inp.
CSI_CLKN*	Clock Neg. Inp.
CSI_CLKP*	Clock Pos. Inp.
CSI_LANE1P*	Lane1 Pos. Inp.
CSI_LANE1N*	Lane1 Neg. Inp.
CSI_LANE3N*	Lane3 Neg. Inp.
CSI_LANE3P*	Lane3 Pos. Inp.

\*These pins map to special purpose pads on the S32R274 MCU instead of general purpose ports as controlled by the SIUL module. Information for these can be found under "Misc Pins" of "S32R274\_IO\_Signal\_Description\_and\_Input\_multiplexing\_tables\_Revn.xlsx".



# S32R274RRUEVB: Progamring Interface

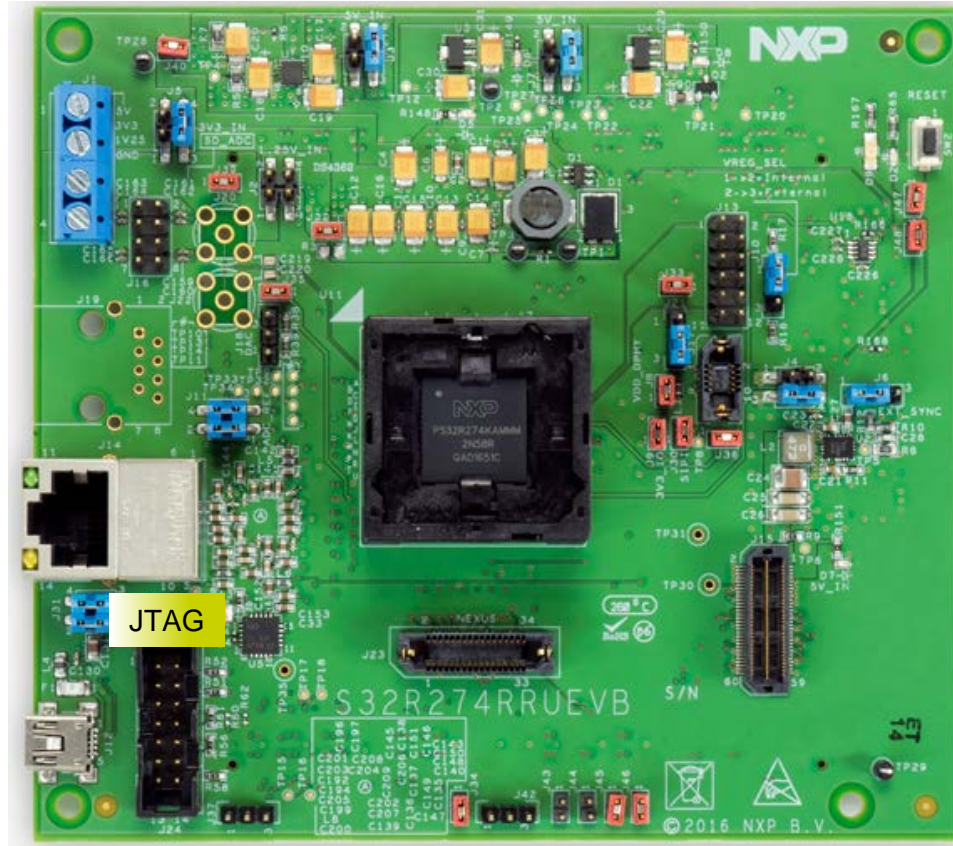

DESCRIPTION	PIN
Support for JTAG-capable debugger such as USB Multilink	J24

# S32R274RRUEVB: Power Supply

S32R274RRUEVB



MPC57xxMB

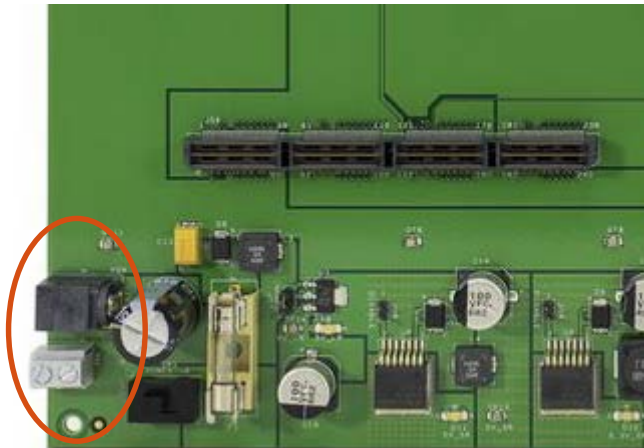

The S32R274RRUEVB supports two power options. You can directly power the MCU power rails via the power terminals on J1 of S32R274RRUEVB; or you can plug it into a MPC57xxMB and power both motherboard and daughter card with a 12V power supply. NXP does not directly sell 12V power supplies. You can obtain a power supply through a third-party vendor.

Power supply specifications:

Fully regulated Switching Power Supply

Input Voltage 100-240V AC 50/60Hz

Output 12V 1A/2A DC

Plug size: 5.5mm x 2.1 mm, Center Positive 



# Package Level Pinout Diagram – S32R274 (257 BGA)

	1	2	3	4	5	6	7	8	9	10	11	12	13	14	15	16	17		
A	SD_0_A DCN	SD_1_A DCN	SD_2_A DCN	SD_3_A DCN	CSI_LA NE2N	CSI_LA NE0N	CSI_CL KN	CSI_LA NE1N	CSI_LA NE3N	VSS_L V_DPH Y	PAD_0	PAD_2	PAD_59	PAD_43	PAD_7	VDD_H V_IO	VSS_H V_IO		AFE
B	SD_0_A DCP	SD_1_A DCP	SD_2_A DCP	SD_3_A DCP	CSI_LA NE2P	CSI_LA NE0P	CSI_CL KP	CSI_LA NE1P	CSI_LA NE3P	VSS_L V_DPH Y	PAD_1	PAD_3	PAD_56	PAD_44	PAD_77	PAD_12	PAD_80		MIPI
C	SD_CM	SD_R	VDD_L V_RAD ARREF	VSS_L V_SDA DC	DAC_C	VDD_H V_SDA 2V5	DAC_A P	DAC_A N	REXT	VSS_L V_DPH Y	VDD_H V_IO_P WM	PAD_62	PAD_10 5	PAD_12 3	PAD_79	PAD_10	PAD_10 4		VREG
D	VDD_H V_RAW	VSS_H V_RAW	VDD_L V_RAD ARDIG	AFE_FI LTER	VSS_H V_REG DAC	VSS_S UB_INP WB1	VSS_H V_DAC	VDD_H V_DAC	VDD_L V_DPH Y	VSS_L V_DPH Y	VSS_H V_IO_P WM	PAD_12 8	PAD_12 4	PAD_42	PAD_8	PAD_19	PAD_13		
E	XOSC XTAL	VDD_L V_SDP LL	VSS_L V_RAD ARDIG	VDD_L V_SDA DC											VSS_H V_IO	VDD_H V_IO	PAD_13 4	PAD_13 6	SAR-ADC
F	XOSC EXTAL	VSS_L V_OSC	VDD_L V_OSC	VSS_L V_SDP LL		VDD	VSS	VDD	VSS	VDD	VSS	VDD		PAD_5	PAD_11	PAD_94	VDD_H V_FL		AURORA
G	NC	NC	VDD_L V_SDC LK	VSS_L V_SDC LK		VDD	VDD	VDD	VDD	VDD	VSS	VDD		PAD_13 7	PAD_4	VPP0	JCOMP		LFAST
H	NC	NC	VSS_S UB_INP WB0	VSS_S UB_OU TPWB		VDD	VSS	VDD	VSS	VSS	VSS	VDD		PAD_21	TCK	PAD_12 9	PAD_6		IO
J	NC	NC	VDD_L V_IO_A URORA	ADC1_ AN_0		VSS	VSS	VSS	VSS	VSS	VSS	VSS		PAD_22	TMS	PAD_11 8	PAD_95		ETHERNET
K	NC	NC	VSS_L V_IO_A URORA	ADC1_ AN_2		VDD	VSS	VSS	VSS	VDD	VSS	VDD		VDD_H V_IO	PAD_10 1	PAD_20	PAD_18		FCCU
L	ADC1_ AN_1	ADC1_ AN_3	VDD_H V_ADC	VSS_H V_ADC		VSS	VDD	VDD	VDD	VDD	VDD	VSS		VSS_H V_IO	PAD_16	PAD_15	PAD_9		RESET_BUT AG
M	VDD_H V_ADC REF1	VSS_H V_ADC REF1	ADC0_ AN_0	ADC0_ AN_4		VDD	VSS	VDD	VSS	VDD	VSS	VDD		FCCU_ F_1	PAD_14	PAD_13 3	PAD_17		RGMI
N	ADC0_ AN_1	VDD_H V_ADC REF0	ADC0_ AN_2	VDD_H V_ADC										VREG_ SEL	VREG_ SENS	NMI	VDD_H V_IO		
P	ADC0_ AN_3	VSS_H V_ADC REF0	ADC0_ AN_7	VSS_H V_ADC	AR_TXP _2	VDD_L V_IO_A URORA	VSS_L V_IO_A URORA	VSS_H V_IO	VSS_L V_PLLO	PAD_51	PAD_47	VSS_H V_IO	PAD_11 7	PAD_12 5	VDD_H V_PMU	VREG_ POR_B	VSS_H V_IO		
R	ADC0_ AN_5	ADC0_ AN_8	ADC0_ AN_12 ADC1_ AN_12	VSS_L V_IO_A URORA	AR_TXN _0	AR_TXN _2	VDD_L V_IO_A URORA	VDD_H V_IO_L FAST	VDD_L V_PLLO	PAD_48	PAD_10 6	VDD_H V_IO_R GMII	PAD_11 6	PAD_11 9	VSS_H V_PMU	VREG_ SWP	FCCU_ F_0		
T	ADC0_ AN_6	ADC0_ AN_13 ADC1_ AN_13	ADC0_ AN_11 ADC1_ AN_11	AR_TXP _0	AR_TXP _1	AR_TXP _3	VDD_L V_LFA STPLL	LFAST_ RXP	LFAST_ TXN	PAD_12 1	PAD_52	PAD_53	PAD_49	PAD_12 0	VDD_H V_REG 3V8	VSS_H V_REG 3V8	RESET _B		
U	VSS_H V_ADC	ADC0_ AN_14 ADC1_ AN_14	AR_CL KN_0	AR_CL KP_0	AR_TXN _1	AR_TXN _3	VSS_L V_LFA STPLL	LFAST_ RXN	LFAST_ TXP	PAD_13 2	PAD_10 7	PAD_13 0	PAD_54	PAD_50	PAD_13 5	VDD_H V_IO	VSS_H V_IO		



# Software Development Tools

- S32 Design Studio IDE for Power Architecture
- IDE & Compilers
  - Free S32 Design Studio IDE with GCC compiler
  - GHS MULTI Integrated Development Environment
  - Cosmic IDE
  - iSystems winIDEA IDE
  - Sourcery™ CodeBench Development Tools
- Debuggers
  - Free OpenSDA debugger on board and supported by S32DS IDE
  - P&E USB Multilink
  - iSystems iC6000
  - Lauterbach TRACE32 JTAG Debugger



# Pre-Compiled Code Examples

- Pre-compiled example projects are available in S32DS as well as in the Quick Start Package
- Example projects also includes the projects from Application Note, [AN4830: Qorivva Recipes for MPC574xG](#), migrated to S32R274 platform to help familiarize you to the board

NOTE: Run these examples with S32DS for Power Architecture v2017.R1 or later

## List of code examples:

1. Hello World
2. Hello World + PLL
3. Hello World + PLL + Interrupts
4. ADC
5. DMA
6. eTimer Frequency Measurement
7. eTimer Count
8. Flash ECC
9. FlexCAN (coming soon)
11. UART
12. SPI
13. SPI+DMA
14. TSENS
15. XBIC+DMA
16. FlexPWM
17. Low Power STOP
18. Register Protection
19. FCCU



# S32R Application Examples (coming soon!)

- S32R Application Demos are advanced code examples that demonstrate radar applications with the S32R
- S32R works alongside an analog radar transceiver to create advanced radar functions such as radar detection

## List of code examples:

1. S32R Dolphin Demo
2. S32R Standalone Demo
3. S32R RADAR Demo

NOTE: Run these examples with S32DS for Power Architecture v2017.R1 or later



# Documentation and Reference Material

- **Documentation Links**

- [S32R274 Datasheet](#)
- [S32R274 Factsheet](#)

- **Application Notes**

- [S32R Radar Signal Compression](#)
- [S32R27/37 Hardware Design Guide](#)
- [Clock Monitor Unit Guide](#)
- [e200 Core Memory Protection Unit Guide](#)

- **Reference Manuals**

- [S32R274 Family Reference Manual](#)
- [S32R274 Family Safety Manual](#)

# Radar Family – Product Feature Differences

- S32R274 is the successor to the MPC5775K radar processor
- Selected features below

MCU	FEATURES				
	Flash*	RAM	EE PROM	Security	Transceiver Interface
S32R274	2.0MB	1.5MB	Emulate	Yes	1 x 4-lane MIPI-CSI2
MPC5775K	4.0MB	1.5MB	Emulate	No	1 x PDI

\*Differences in memory are all in the Large Flash Block

# Recommendations

- For faster debugging, debug from RAM, because this cuts down the lengthy Flash erase operation cycles. Follow the Software Integration Guide (SWIG) for details.
- By default “New Project” in S32 Design Studio IDE makes application to run at 16 MHz Internal RC (IRC) oscillator. For faster performance, configure PLL to desired frequency and switch clock source to PLL before executing application code.
- Keep S32 Design Studio IDE and OpenSDA firmware Up-to-date for best results
- Post Technical Questions on NXP community for [MPC5xxx](#).
- Useful Links:
  - [S32R Webpage](#)
  - [S32RXXEVB Webpage](#)
  - [nxp.com/s32ds](http://nxp.com/s32ds)
  - [nxp.com/community](http://nxp.com/community)



SECURE CONNECTIONS  
FOR A SMARTER WORLD