

High Voltage, High Gain BIMOSFET™ Monolithic Bipolar MOS Transistor

IXBT32N300HV IXBH32N300HV

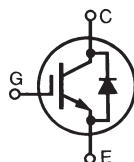

$$V_{CES} = 3000V$$

$$I_{C110} = 32A$$

$$V_{CE(sat)} \leq 3.2V$$

Symbol	Test Conditions	Maximum Ratings	
V_{CES}	$T_C = 25^\circ C$ to $150^\circ C$	3000	V
V_{CGR}	$T_J = 25^\circ C$ to $150^\circ C$, $R_{GE} = 1M\Omega$	3000	V
V_{GES}	Continuous	± 20	V
V_{GEM}	Transient	± 30	V
I_{C25}	$T_C = 25^\circ C$	80	A
I_{C110}	$T_C = 110^\circ C$	32	A
I_{CM}	$T_C = 25^\circ C$, 1ms	280	A
SSOA (RBSOA)	$V_{GE} = 15V$, $T_{VJ} = 125^\circ C$, $R_G = 10\Omega$ Clamped Inductive Load	$I_{CM} = 80$ $V_{CES} \leq 2400$	A V
P_C	$T_C = 25^\circ C$	400	W
T_J		-55 ... +150	$^\circ C$
T_{JM}		150	$^\circ C$
T_{stg}		-55 ... +150	$^\circ C$
T_L	Maximum Lead Temperature for Soldering	300	$^\circ C$
T_{SOLD}	Plastic Body for 10s	260	$^\circ C$
M_d	Mounting Torque (TO-247HV)	1.13/10	Nm/lb.in.
Weight	TO-268HV	4	g
	TO-247HV	6	g

Symbol	Test Conditions	Characteristic Values		
		Min.	Typ.	Max.
BV_{CES}	$I_C = 250\mu A$, $V_{GE} = 0V$	3000		V
$V_{GE(th)}$	$I_C = 250\mu A$, $V_{CE} = V_{GE}$	2.5		V
I_{CES}	$V_{CE} = 0.8 \cdot V_{CES}$, $V_{GE} = 0V$ $T_J = 125^\circ C$			50 μA 2 mA
I_{GES}	$V_{CE} = 0V$, $V_{GE} = \pm 20V$			± 100 nA
$V_{CE(sat)}$	$I_C = 32A$, $V_{GE} = 15V$, Note 1 $T_J = 125^\circ C$		2.8 3.5	V V

TO-268HV (IXBT)

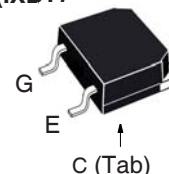

TO-247HV (IXBH)

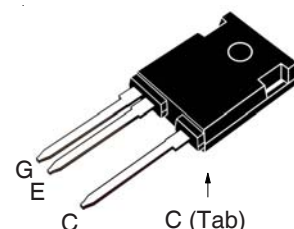

G = Gate C = Collector
E = Emitter Tab = Collector

Features

- High Blocking Voltage
- High Voltage Packages
- Low Conduction Losses

Advantages

- Low Gate Drive Requirement
- High Power Density

Applications:

- Switched-Mode and Resonant-Mode Power Supplies
- Uninterruptible Power Supplies (UPS)
- Laser Generators
- Capacitor Discharge Circuits
- AC Switches

Symbol Test Conditions ($T_J = 25^\circ\text{C}$ Unless Otherwise Specified)		Characteristic Values		
		Min.	Typ.	Max.
g_{fS}	$I_C = 32\text{A}, V_{CE} = 10\text{V}, \text{Note 1}$	16	26	S
C_{ies}	$V_{CE} = 25\text{V}, V_{GE} = 0\text{V}, f = 1\text{MHz}$		3140	pF
C_{oes}			124	pF
C_{res}			40	pF
Q_g	$I_C = 32\text{A}, V_{GE} = 15\text{V}, V_{CE} = 1000\text{V}$		142	nC
Q_{ge}			20	nC
Q_{gc}			57	nC
$t_{d(on)}$	Resistive Switching Times, $T_J = 25^\circ\text{C}$ $I_C = 32\text{A}, V_{GE} = 15\text{V}$ $V_{CE} = 1250\text{V}, R_G = 2\Omega$		50	ns
t_r			185	ns
$t_{d(off)}$			160	ns
t_f			720	ns
$t_{d(on)}$	Resistive Switching Times, $T_J = 125^\circ\text{C}$ $I_C = 32\text{A}, V_{GE} = 15\text{V}$ $V_{CE} = 1250\text{V}, R_G = 2\Omega$		58	ns
t_r			515	ns
$t_{d(off)}$			165	ns
t_f			630	ns
R_{thJC}	(TO-247HV)			0.31 $^\circ\text{C/W}$
R_{thCS}			0.21	$^\circ\text{C/W}$

Reverse Diode

Symbol Test Conditions ($T_J = 25^\circ\text{C}$ Unless Otherwise Specified)		Characteristic Values		
		Min.	Typ.	Max.
V_F	$I_F = 32\text{A}, V_{GE} = 0\text{V}$			2.1 V
t_{rr}	$I_F = 16\text{A}, V_{GE} = 0\text{V}, -di_F/dt = 100\text{A}/\mu\text{s}$ $V_R = 100\text{V}, V_{GE} = 0\text{V}$		1.5	μs
I_{RM}			33	A

Note 1: Pulse Test, $t \leq 300\mu\text{s}$, Duty Cycle, $d \leq 2\%$.

ADVANCE TECHNICAL INFORMATION

The product presented herein is under development. The Technical Specifications offered are derived from a subjective evaluation of the design, based upon prior knowledge and experience, and constitute a "considered reflection" of the anticipated result. IXYS reserves the right to change limits, test conditions, and dimensions without notice.

IXYS Reserves the Right to Change Limits, Test Conditions and Dimensions.

IXYS MOSFETs and IGBTs are covered by one or more of the following U.S. patents: 4,835,592 4,931,844 5,049,961 5,237,481 6,162,665 6,404,065 B1 6,683,344 6,727,585 7,005,734 B2 7,157,338B2
4,860,072 5,017,508 5,063,307 5,381,025 6,259,123 B1 6,534,343 6,710,405 B2 6,759,692 7,063,975 B2
4,881,106 5,034,796 5,187,117 5,486,715 6,306,728 B1 6,583,505 6,710,463 6,771,478 B2 7,071,537

Fig. 1. Output Characteristics @ $T_J = 25^\circ\text{C}$

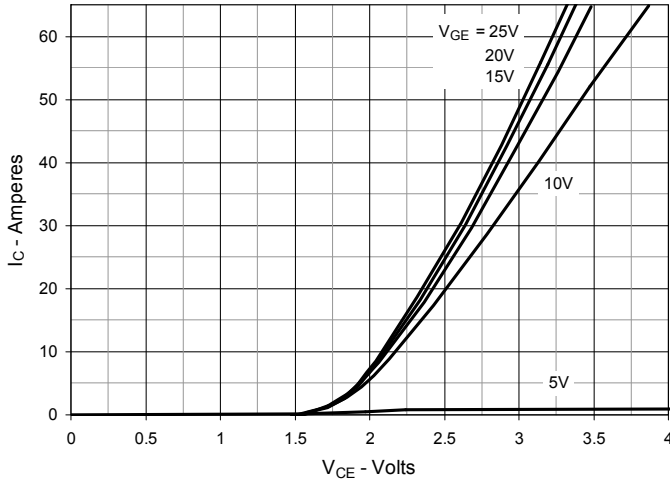

Fig. 2. Extended Output Characteristics @ $T_J = 25^\circ\text{C}$

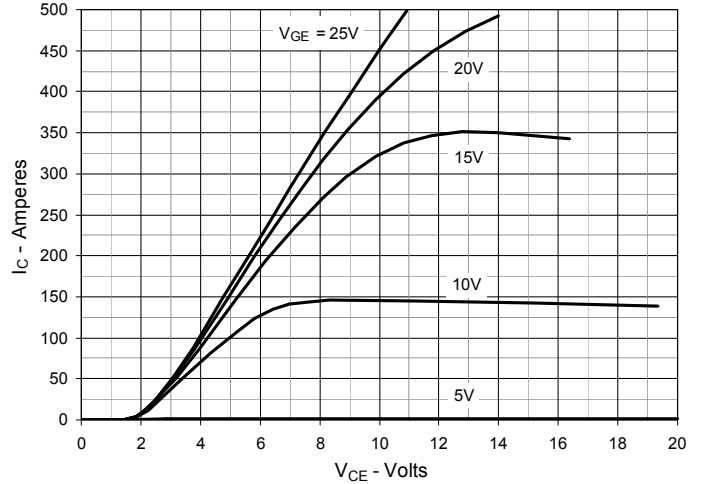

Fig. 3. Output Characteristics @ $T_J = 125^\circ\text{C}$

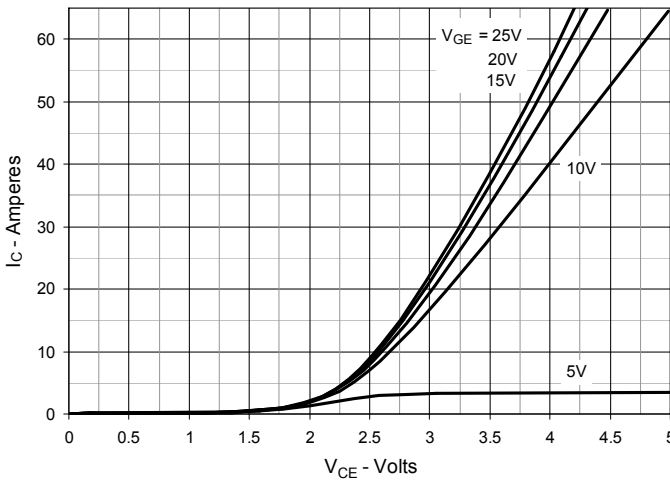

Fig. 4. Dependence of $V_{CE(sat)}$ on Junction Temperature

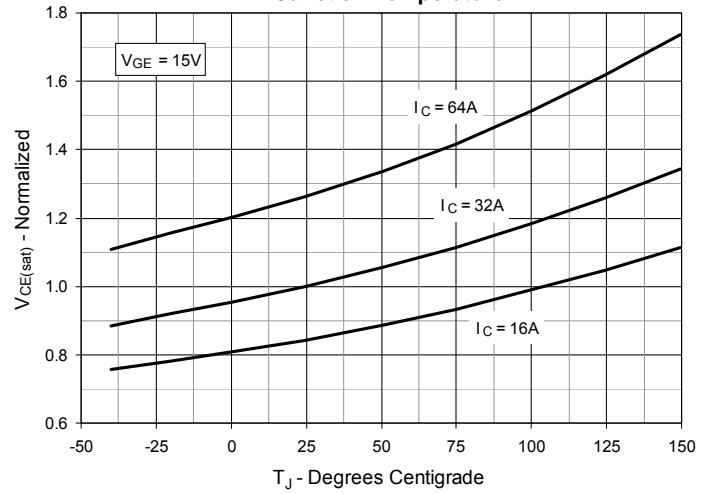

Fig. 5. Collector-to-Emitter Voltage vs. Gate-to-Emitter Voltage

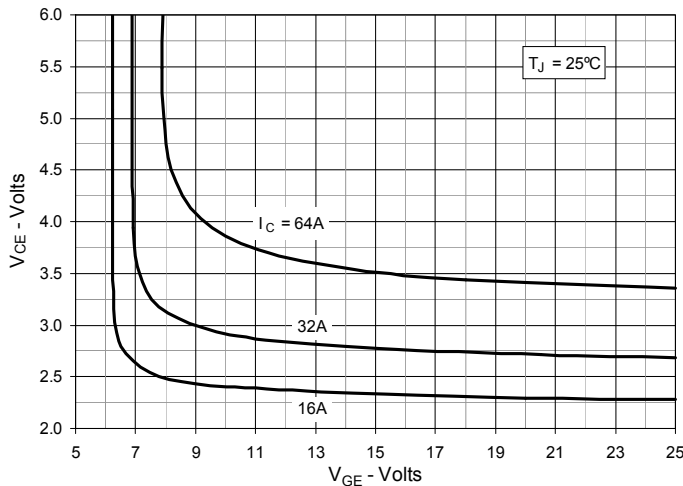

Fig. 6. Input Admittance

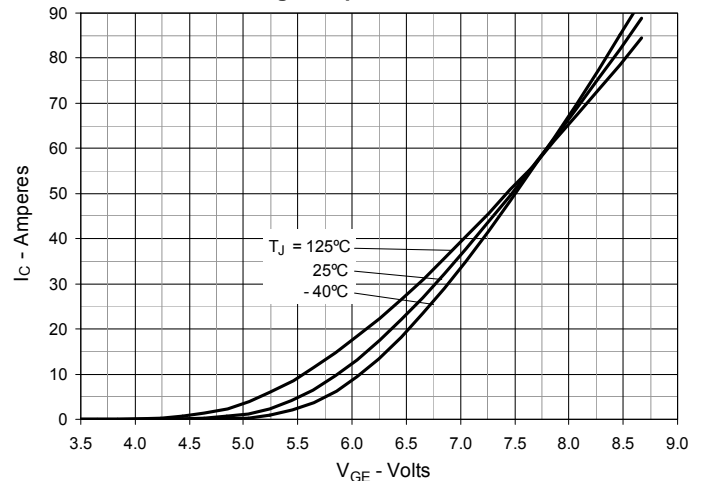

Fig. 7. Transconductance

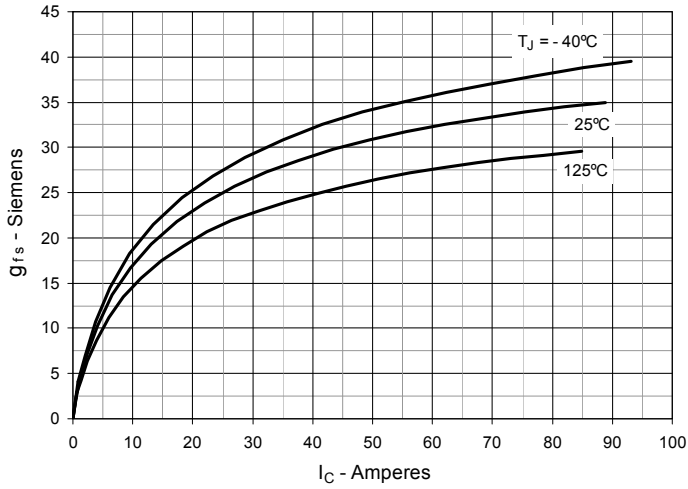

Fig. 8. Forward Voltage Drop of Intrinsic Diode

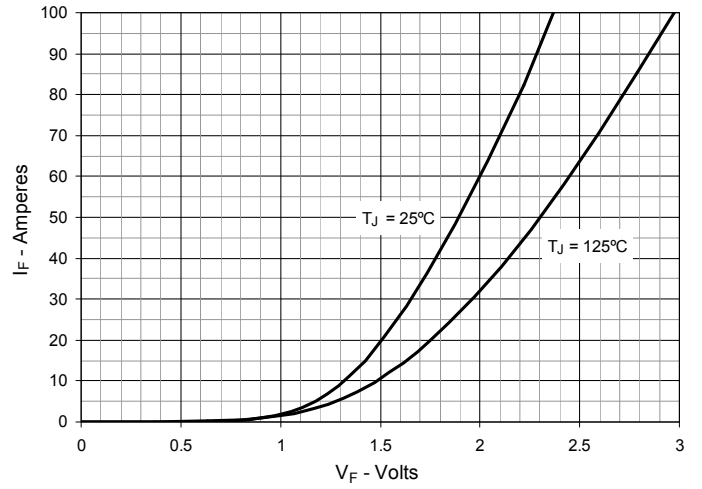

Fig. 9. Gate Charge

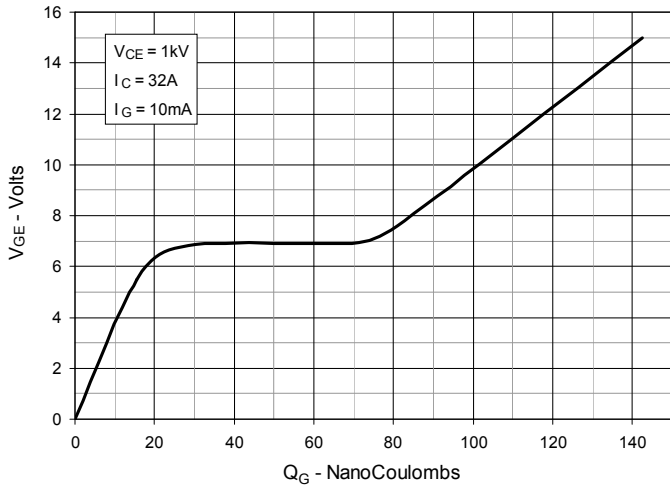

Fig. 10. Capacitance

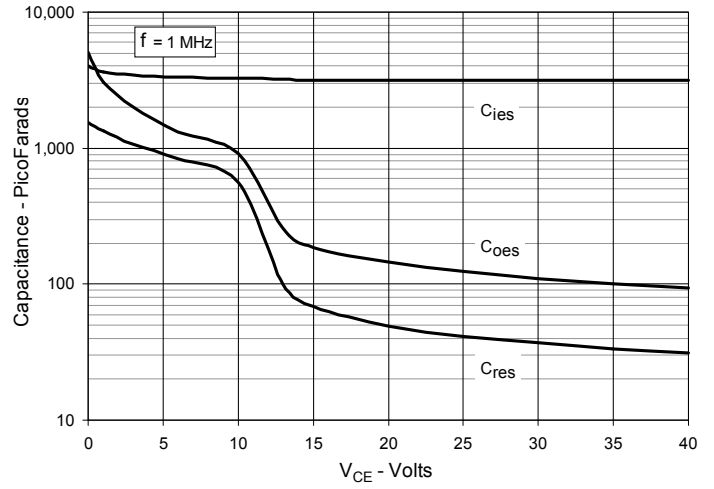

Fig. 11. Reverse-Bias Safe Operating Area

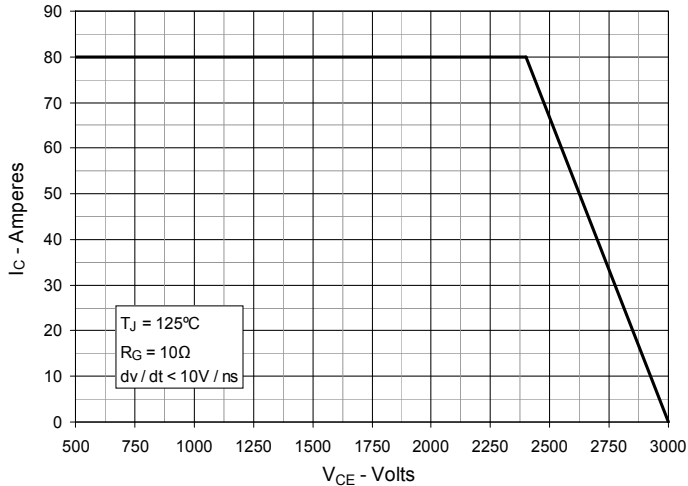

Fig. 12. Maximum Transient Thermal Impedance

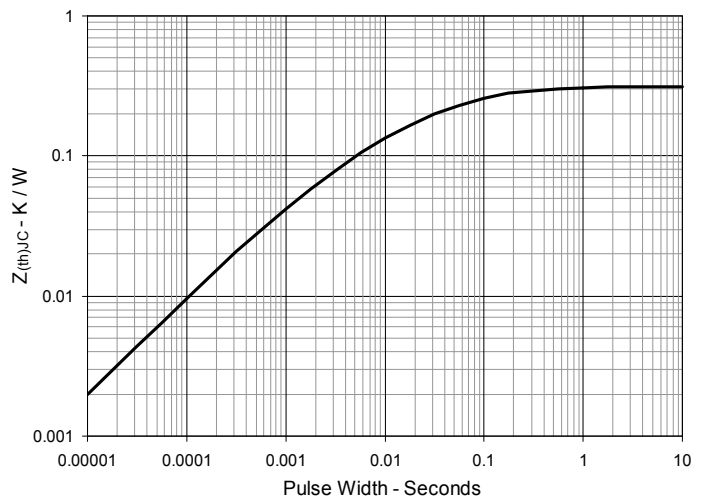

Fig. 13. Resistive Turn-on Rise Time vs. Junction Temperature

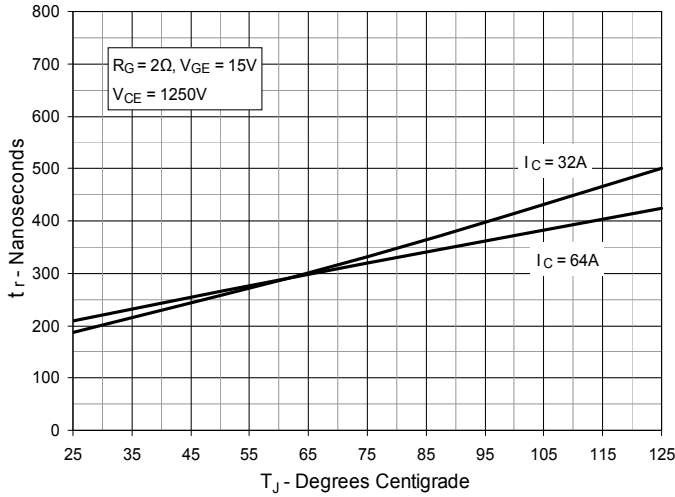

Fig. 14. Resistive Turn-on Rise Time vs. Drain Current

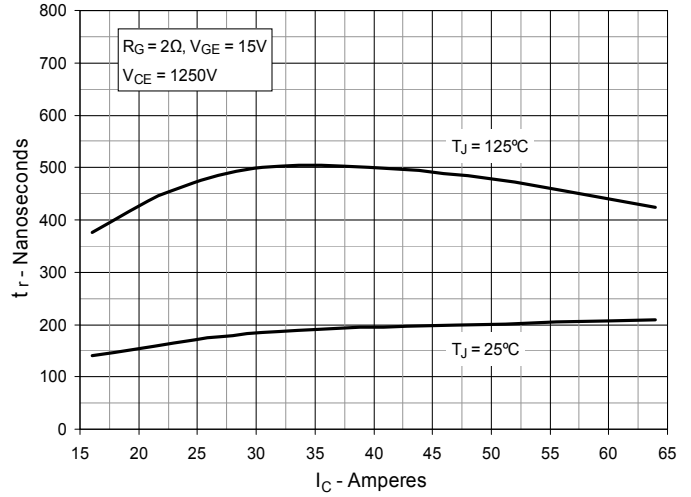

Fig. 15. Resistive Turn-on Switching Times vs. Gate Resistance

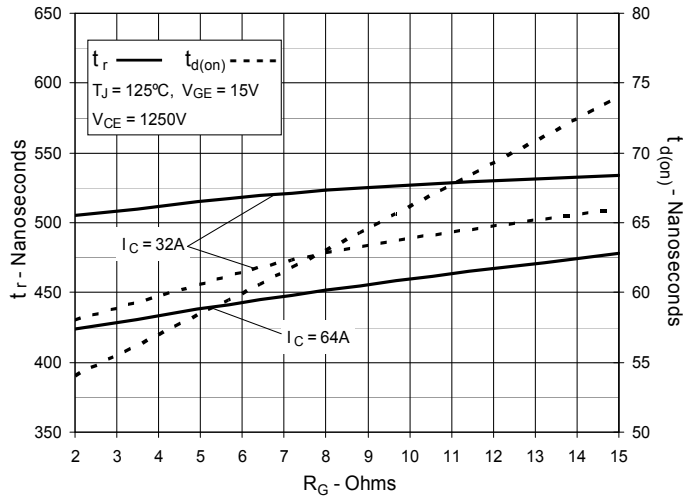

Fig. 16. Resistive Turn-off Switching Times vs. Junction Temperature

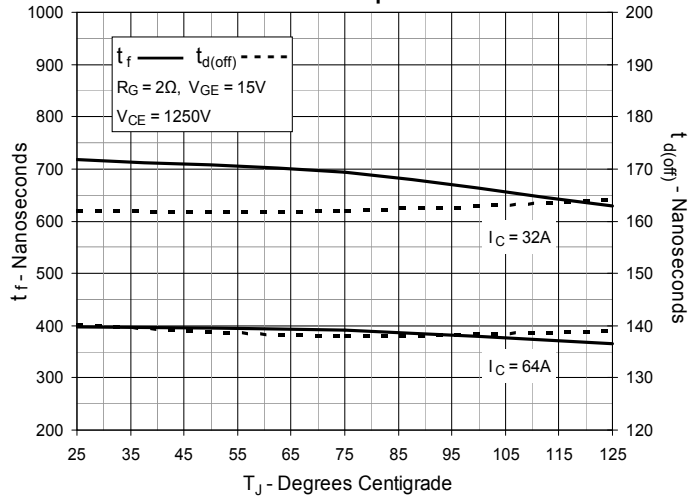

Fig. 17. Resistive Turn-off Switching Times vs. Drain Current

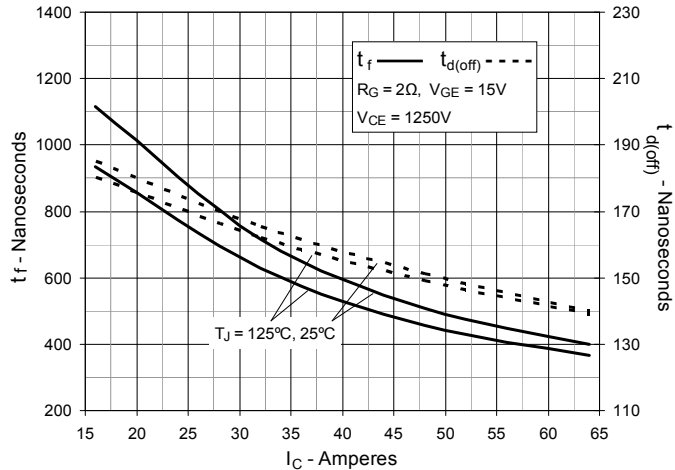
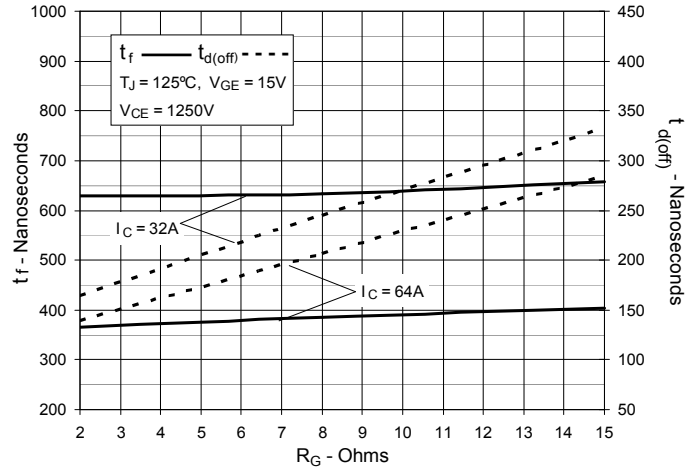
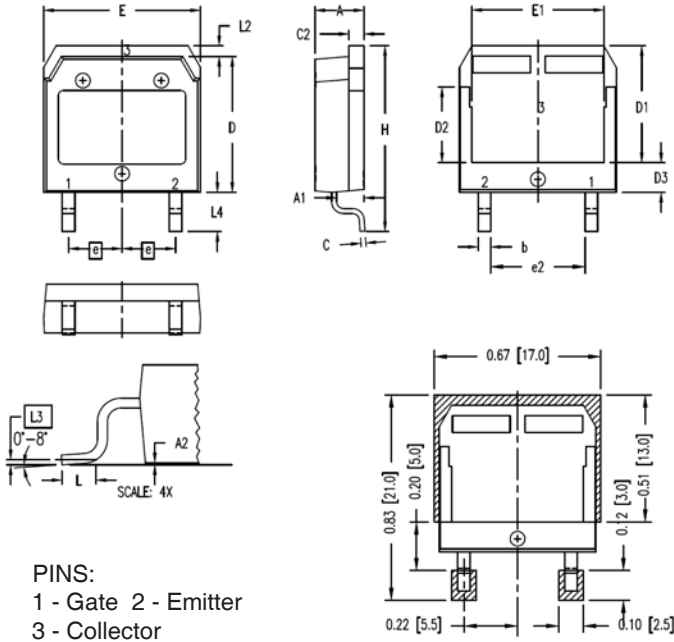
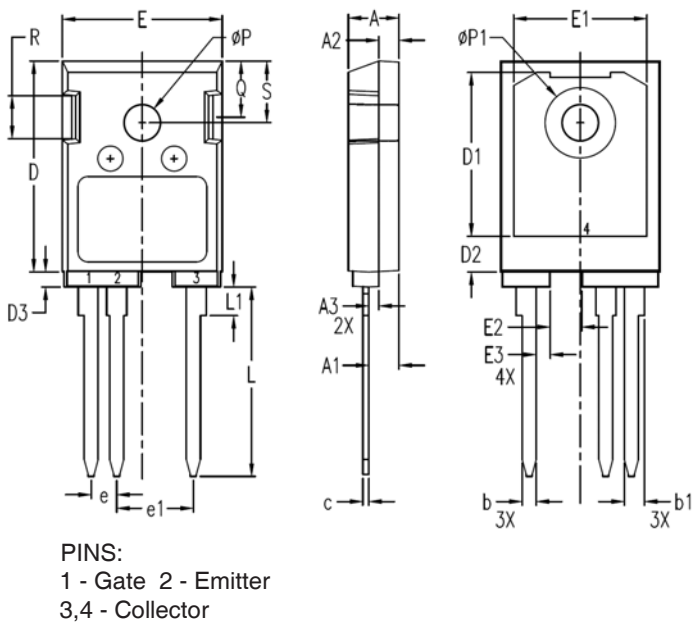

Fig. 18. Resistive Turn-off Switching Times vs. Gate Resistance



TO-268HV (IXBT)

SYM	INCHES		MILLIMETER	
	MIN	MAX	MIN	MAX
A	.193	.201	4.90	5.10
A1	.106	.114	2.70	2.90
A2	.001	.010	0.02	0.25
b	.045	.057	1.15	1.45
C	.016	.026	0.40	0.65
C2	.057	.063	1.45	1.60
D	.543	.551	13.80	14.00
D1	.465	.476	11.80	12.10
D2	.295	.307	7.50	7.80
D3	.114	.126	2.90	3.20
E	.624	.632	15.85	16.05
E1	.524	.535	13.30	13.60
\square	.215 BSC		5.45 BSC	
(e2)	.374	.386	9.50	9.80
H	.736	.752	18.70	19.10
L	.067	.079	1.70	2.00
L2	.039	.045	1.00	1.15
\square L3	.010 BSC		0.25 BSC	
L4	.150	.161	3.80	4.10

TO-247HV (IXBH)

SYM	INCHES		MILLIMETERS	
	MIN	MAX	MIN	MAX
A	.193	.201	4.90	5.10
A1	.114	.122	2.90	3.10
A2	.075	.083	1.90	2.10
A3	.035	.043	0.90	1.10
b	.053	.059	1.35	1.50
b1	.075	.083	1.90	2.10
c	.022	.030	0.55	0.75
D	.819	.843	20.80	21.40
D1	.638	.646	16.20	16.40
D2	.134	.146	3.40	3.70
D3	.055	.063	1.40	1.60
E	.622	.638	15.80	16.20
E1	.520	.528	13.20	13.40
E2	.118	.126	3.00	3.20
E3	.051	.059	1.30	1.50
e	.100 BSC		2.54 BSC	
e1	.300 BSC		7.62 BSC	
L	.724	.748	18.40	19.00
L1	.106	.118	2.70	3.00
ϕ P	.138	.142	3.50	3.60
ϕ P1	.272	.280	6.90	7.10
Q	.216	.224	5.50	5.70
R	.165	.169	4.20	4.30
S	.240	.248	6.10	6.30



Disclaimer Notice - Information furnished is believed to be accurate and reliable. However, users should independently evaluate the suitability of and test each product selected for their own applications. Littelfuse products are not designed for, and may not be used in, all applications. Read complete Disclaimer Notice at www.littelfuse.com/disclaimer-electronics.