

N and P-Channel Enhancement Mode Power MOSFET

Description

The RM2003 uses advanced trench technology to provide excellent $R_{DS(ON)}$ and low gate charge. The complementary MOSFETs may be used to form a level shifted high side switch, and for a host of other applications.

General Features

● N-Channel

- $V_{DS} = 20V, I_D = 3A$
- $R_{DS(ON)} < 35m\Omega @ V_{GS}=4.5V$
- $R_{DS(ON)} < 55m\Omega @ V_{GS}=2.5V$

● P-Channel

- $V_{DS} = -20V, I_D = -3A$
- $R_{DS(ON)} < 75m\Omega @ V_{GS}=-4.5V$
- $R_{DS(ON)} < 100m\Omega @ V_{GS}=-2.5V$

- High power and current handing capability
- Lead free product is acquired
- Surface mount package
- Halogen-free
- P/N suffix V means AEC-Q101 qualified, e.g:RM2003V

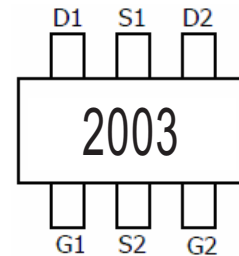
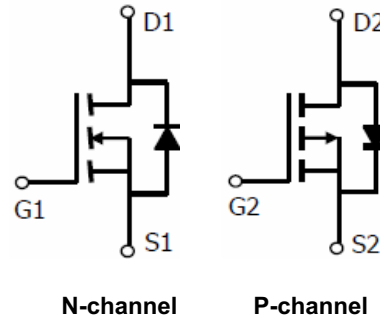

Marking and pin Assignment

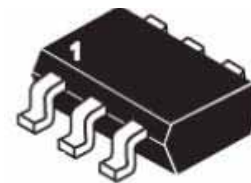

SOT-23-6L top view

Package Marking and Ordering Information

Device Marking	Device	Device Package	Reel Size	Tape width	Quantity
2003	RM2003	SOT-23-6L	Ø180mm	8mm	3000 units

Absolute Maximum Ratings ($T_A=25^\circ C$ unless otherwise noted)

Parameter	Symbol	N-Channel	P-Channel	Unit	
Drain-Source Voltage	V_{DS}	20	-20	V	
Gate-Source Voltage	V_{GS}	± 12	± 12	V	
Continuous Drain Current	I_D	$T_A=25^\circ C$	3	-3	A
		$T_A=70^\circ C$	2.4	-2.4	
Pulsed Drain Current ^(Note 1)	I_{DM}	13	-13	A	
Maximum Power Dissipation	P_D	0.8	0.8	W	
Operating Junction and Storage Temperature Range	T_J, T_{STG}	-55 To 150	-55 To 150	$^\circ C$	

Thermal Characteristic

Thermal Resistance, Junction-to-Ambient ^(Note2)	$R_{\theta JA}$	N-Ch	156	$^\circ C/W$
Thermal Resistance, Junction-to-Ambient ^(Note2)	$R_{\theta JA}$	P-Ch	156	$^\circ C/W$

N-CH Electrical Characteristics ($T_A=25^\circ\text{C}$ unless otherwise noted)

Parameter	Symbol	Condition	Min	Typ	Max	Unit
Off Characteristics						
Drain-Source Breakdown Voltage	BV_{DSS}	$V_{GS}=0V, I_D=250\mu A$	20	22	-	V
Zero Gate Voltage Drain Current	I_{DSS}	$V_{DS}=20V, V_{GS}=0V$	-	-	1	μA
Gate-Body Leakage Current	I_{GSS}	$V_{GS}=\pm 12V, V_{DS}=0V$	-	-	± 100	nA
On Characteristics (Note 3)						
Gate Threshold Voltage	$V_{GS(th)}$	$V_{DS}=V_{GS}, I_D=250\mu A$	0.5	0.75	1.2	V
Drain-Source On-State Resistance	$R_{DS(on)}$	$V_{GS}=2.5V, I_D=2.8A$	-	36	55	m Ω
		$V_{GS}=4.5V, I_D=3A$	-	28	35	m Ω
Forward Transconductance	g_{FS}	$V_{DS}=5V, I_D=3A$	-	8	-	S
Dynamic Characteristics (Note 4)						
Input Capacitance	C_{iss}	$V_{DS}=10V, V_{GS}=0V,$ $F=1.0MHz$	-	260	-	PF
Output Capacitance	C_{oss}		-	48	-	PF
Reverse Transfer Capacitance	C_{rss}		-	27	-	PF
Switching Characteristics (Note 4)						
Turn-on Delay Time	$t_{d(on)}$	$V_{DD}=10V, R_L=3.3\Omega$ $V_{GS}=4.5V, R_{GEN}=6\Omega$	-	2.5	-	nS
Turn-on Rise Time	t_r		-	3.2	-	nS
Turn-Off Delay Time	$t_{d(off)}$		-	21	-	nS
Turn-Off Fall Time	t_f		-	3	-	nS
Total Gate Charge	Q_g	$V_{DS}=10V, I_D=3A,$ $V_{GS}=4.5V$	-	2.9	5	nC
Gate-Source Charge	Q_{gs}		-	0.4	-	nC
Gate-Drain Charge	Q_{gd}		-	0.6	-	nC
Drain-Source Diode Characteristics						
Diode Forward Voltage (Note 3)	V_{SD}	$V_{GS}=0V, I_S=3A$	-	-	1.2	V
Diode Forward Current (Note 2)	I_S		-	-	3	A

Notes:

1. Repetitive Rating: Pulse width limited by maximum junction temperature.
2. Surface Mounted on FR4 Board, $t \leq 10$ sec.
3. Pulse Test: Pulse Width $\leq 300\mu s$, Duty Cycle $\leq 2\%$.
4. Guaranteed by design, not subject to production

P-CH Electrical Characteristics (TA=25°C unless otherwise noted)

Parameter	Symbol	Condition	Min	Typ	Max	Unit
Off Characteristics						
Drain-Source Breakdown Voltage	BV_{DSS}	$V_{GS}=0V, I_D=-250\mu A$	-20		-	V
Zero Gate Voltage Drain Current	I_{DSS}	$V_{DS}=-20V, V_{GS}=0V$	-	-	-1	μA
Gate-Body Leakage Current	I_{GSS}	$V_{GS}=\pm 12V, V_{DS}=0V$	-	-	± 100	nA
On Characteristics (Note 3)						
Gate Threshold Voltage	$V_{GS(th)}$	$V_{DS}=V_{GS}, I_D=-250\mu A$	-0.4	-0.7	-1	V
Drain-Source On-State Resistance	$R_{DS(on)}$	$V_{GS}=-4.5V, I_D=-2.5 A$	-	60	75	m Ω
		$V_{GS}=-2.5V, I_D=-2A$	-	81	100	m Ω
Forward Transconductance	g_{FS}	$V_{DS}=-5V, I_D=-2.5A$	-	9.5	-	S
Dynamic Characteristics (Note 4)						
Input Capacitance	C_{iss}	$V_{DS}=-10V, V_{GS}=0V,$ $F=1.0MHz$	-	325	-	PF
Output Capacitance	C_{oss}		-	63	-	PF
Reverse Transfer Capacitance	C_{rss}		-	37	-	PF
Switching Characteristics (Note 4)						
Turn-on Delay Time	$t_{d(on)}$	$V_{DD}=-10V, R_L=5\Omega$ $V_{GS}=-4.5V, R_{GEN}=3\Omega$	-	11	-	nS
Turn-on Rise Time	t_r		-	5.5	-	nS
Turn-Off Delay Time	$t_{d(off)}$		-	22	-	nS
Turn-Off Fall Time	t_f		-	8	-	nS
Total Gate Charge	Q_g	$V_{DS}=-10V, I_D=-2A,$ $V_{GS}=-4.5V$	-	3.2	-	nC
Gate-Source Charge	Q_{gs}		-	0.6	-	nC
Gate-Drain Charge	Q_{gd}		-	0.9	-	nC
Drain-Source Diode Characteristics						
Diode Forward Voltage (Note 3)	V_{SD}	$V_{GS}=0V, I_S=-3A$	-	-	-1.2	V
Diode Forward Current (Note 2)	I_S		-	-	-3	A

Notes:

1. Repetitive Rating: Pulse width limited by maximum junction temperature.
2. Surface Mounted on FR4 Board, $t \leq 10$ sec.
3. Pulse Test: Pulse Width $\leq 300\mu s$, Duty Cycle $\leq 2\%$.
4. Guaranteed by design, not subject to production

N- Channel Typical Electrical and Thermal Characteristics (Curves)

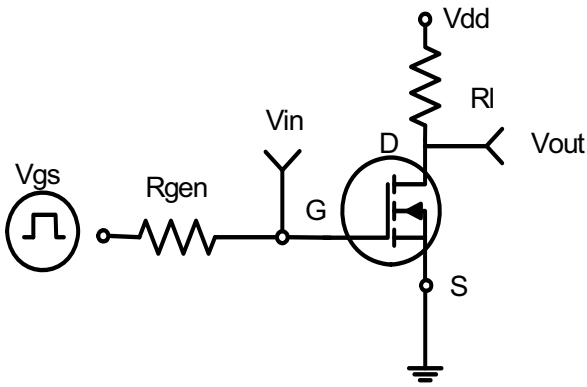

Figure 1: Switching Test Circuit

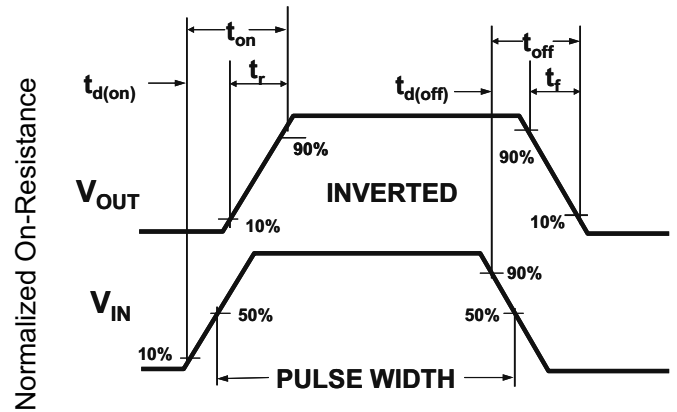

Figure 2: Switching Waveforms

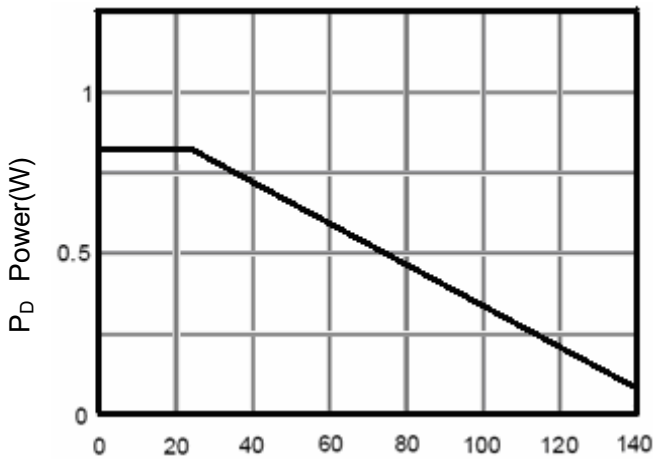

Figure 3 Power Dissipation

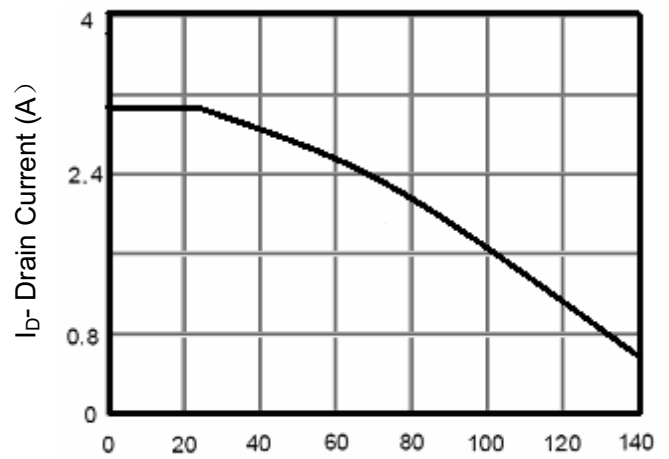

Figure 4 Drain Current

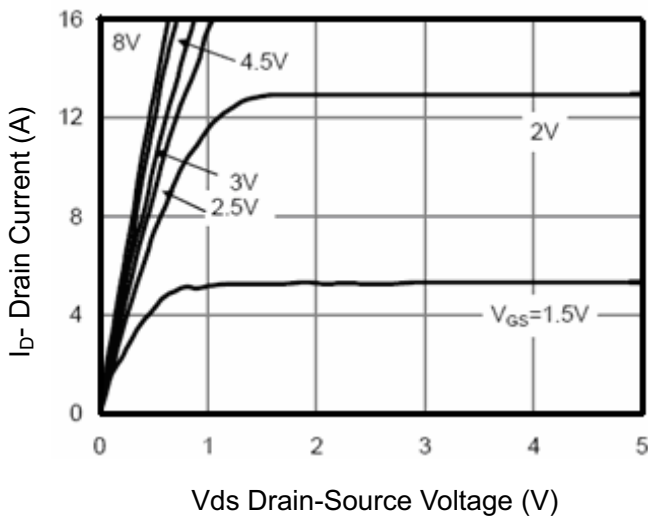

Figure 5 Output Characteristics

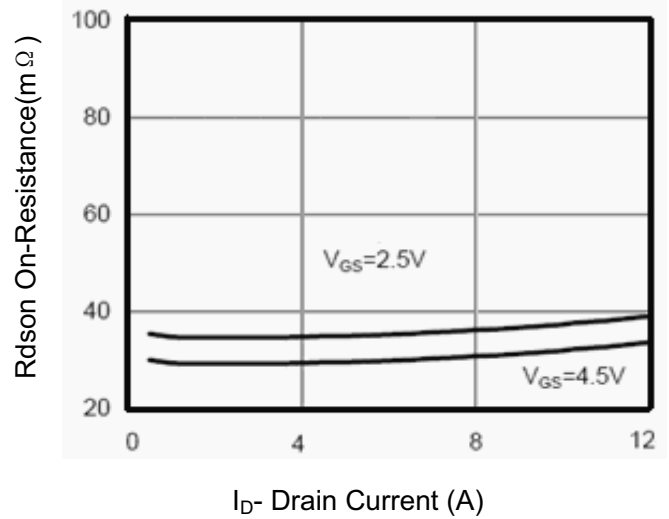

Figure 6 Drain-Source On-Resistance

N- Channel Typical Electrical and Thermal Characteristics (Curves)

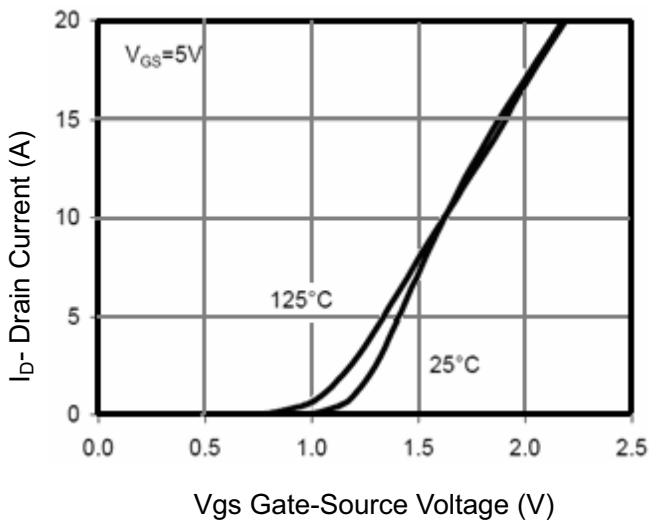

Figure 7 Transfer Characteristics

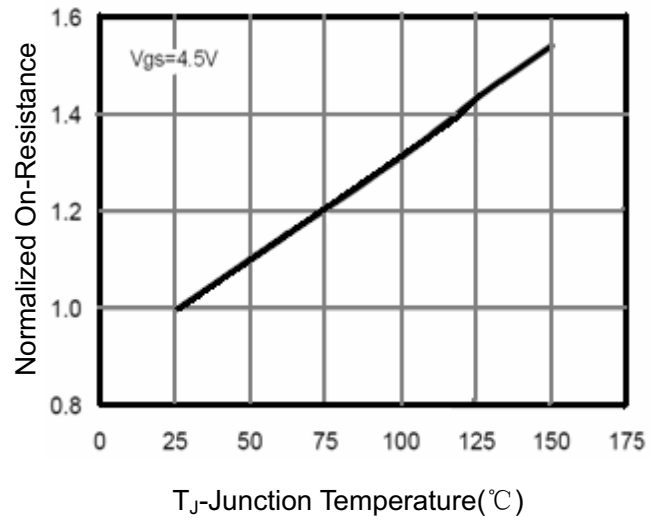

Figure 8 Drain-Source On-Resistance

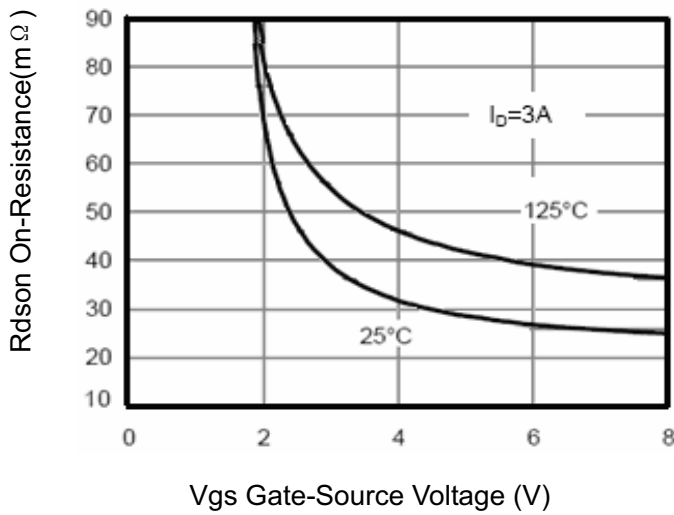

Figure 9 Rdson vs Vgs

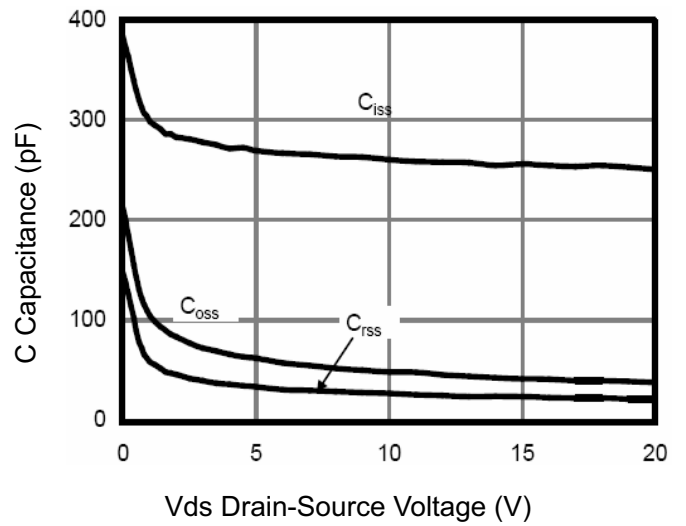

Figure 10 Capacitance vs Vds

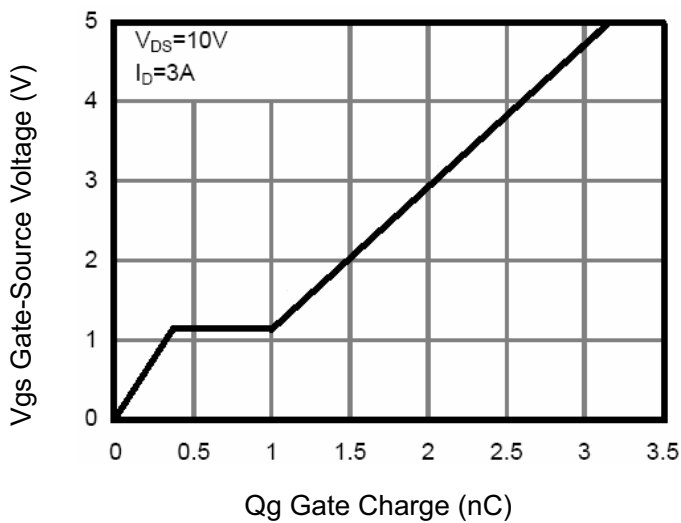

Figure 11 Gate Charge

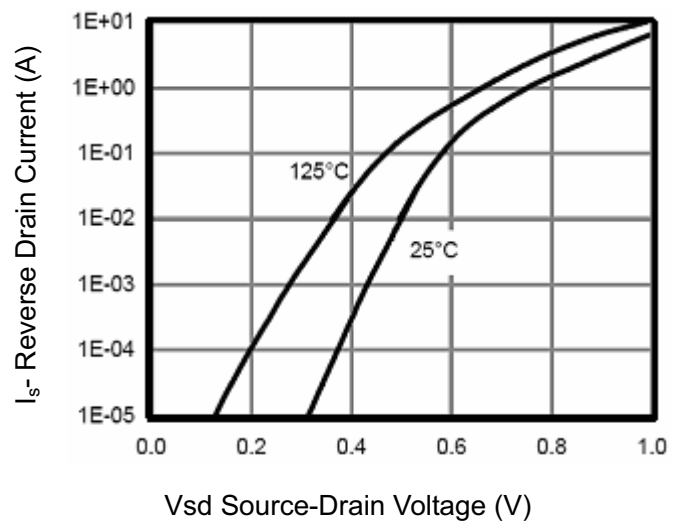

Figure 12 Source- Drain Diode Forward

N- Channel Typical Electrical and Thermal Characteristics (Curves)

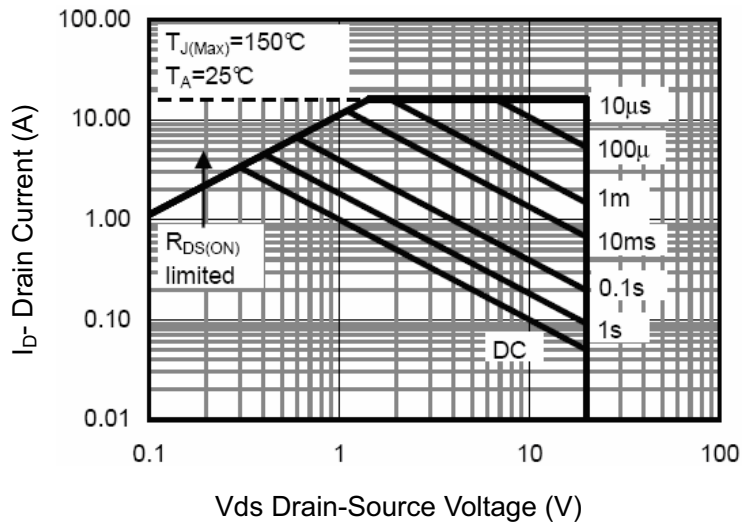

Figure 13 Safe Operation Area

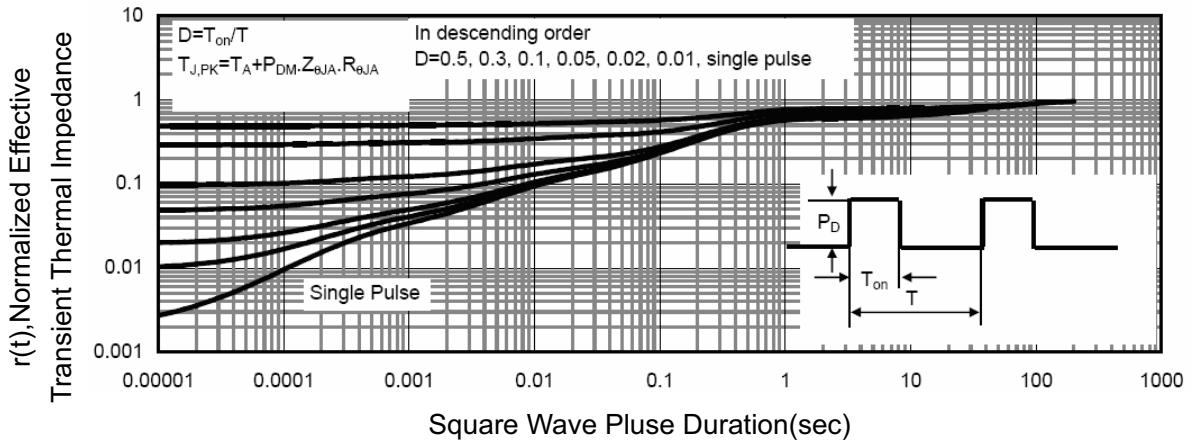

Figure 14 Normalized Maximum Transient Thermal Impedance

P- Channel Typical Electrical and Thermal Characteristics (Curves)

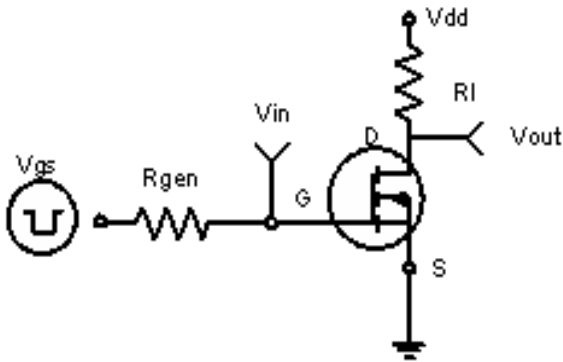

Figure 1: Switching Test Circuit

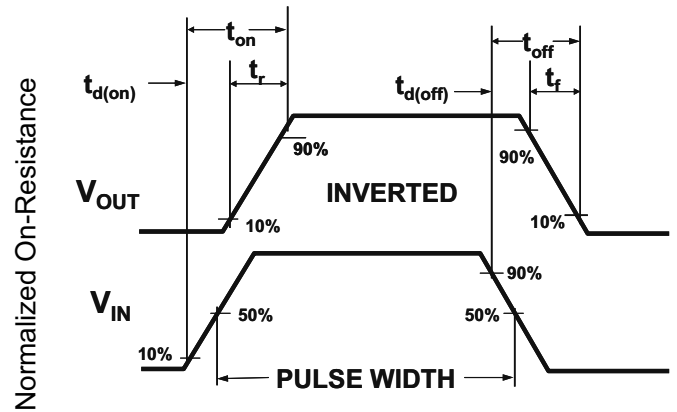

Figure 2: Switching Waveforms

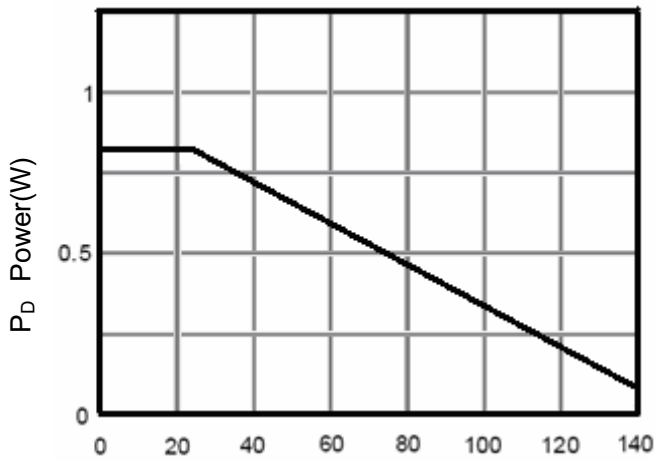

Figure 3 Power Dissipation

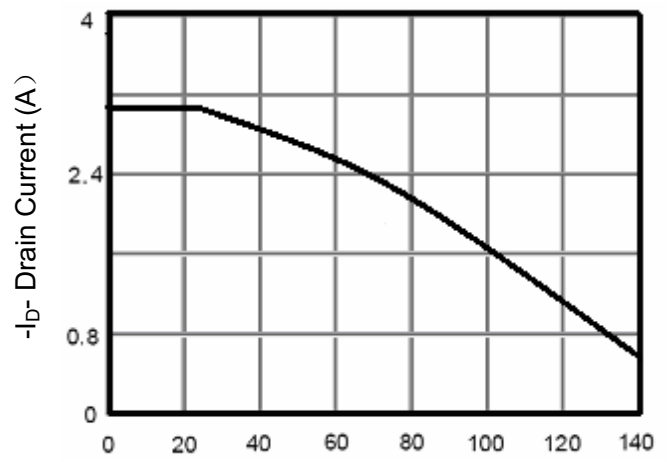

Figure 4 Drain Current

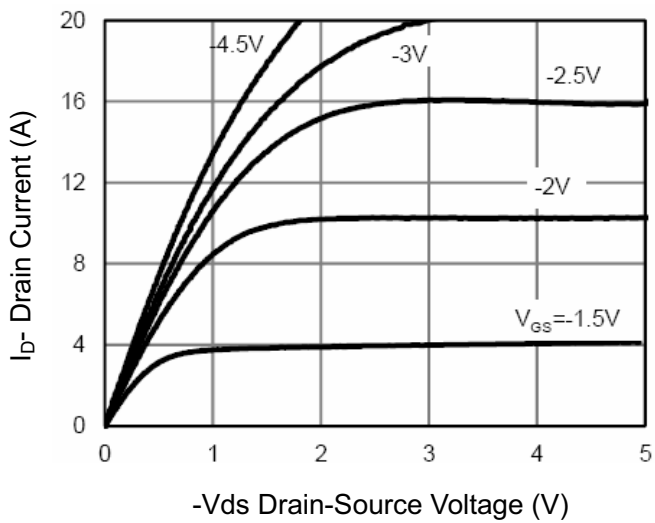

Figure 5 Output Characteristics

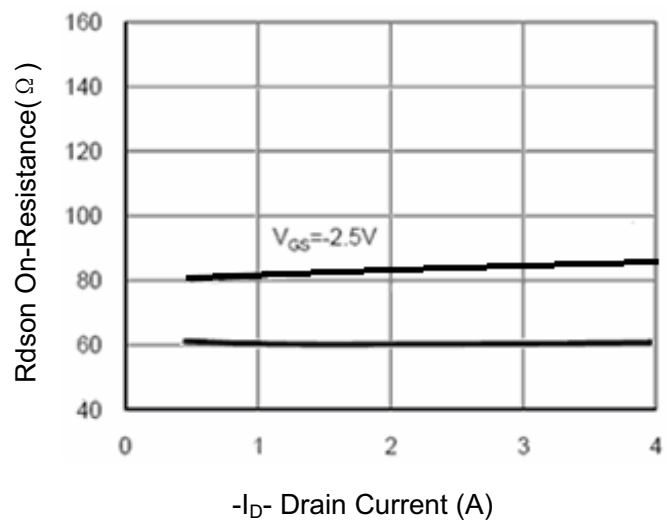

Figure 6 Drain-Source On-Resistance

P- Channel Typical Electrical and Thermal Characteristics (Curves)

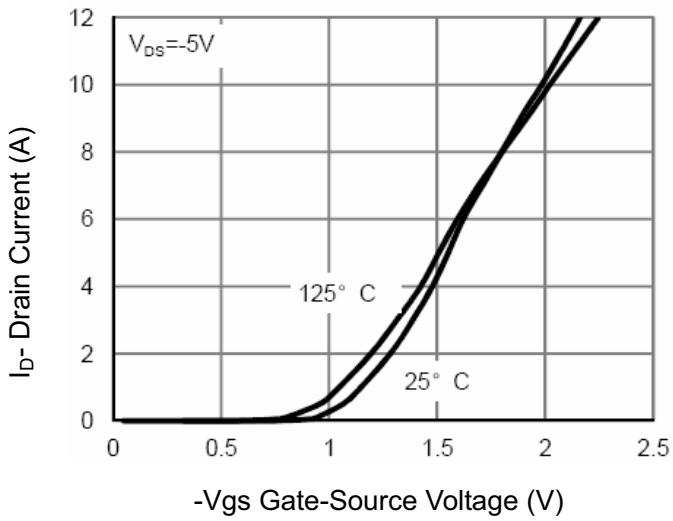

Figure 7 Transfer Characteristics

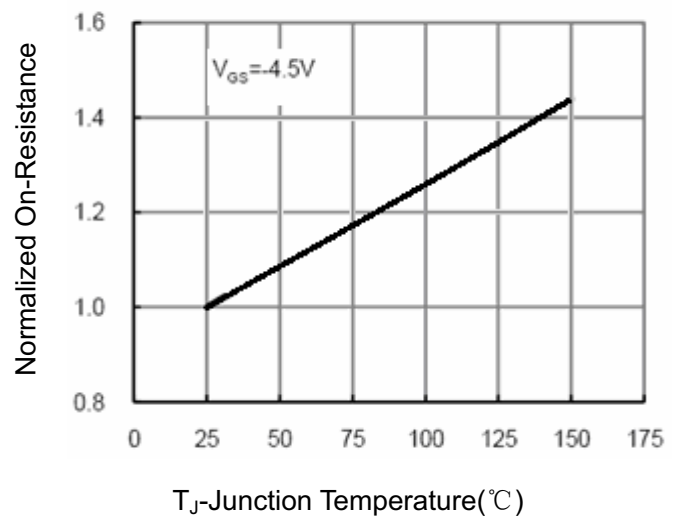

Figure 8 Drain-Source On-Resistance

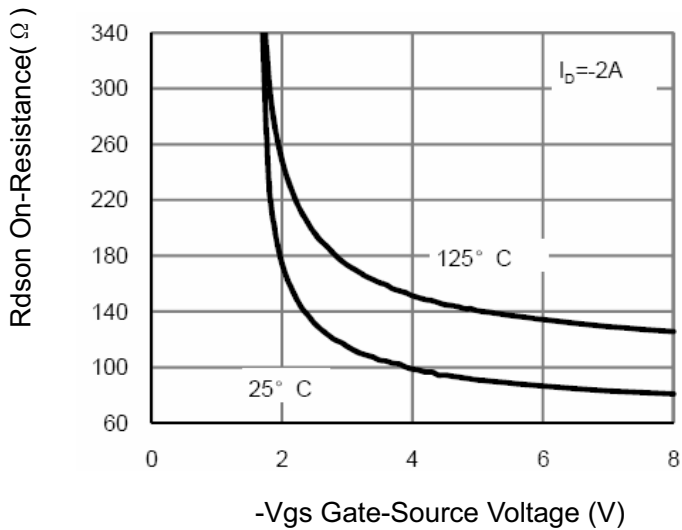

Figure 9 Rdson vs Vgs

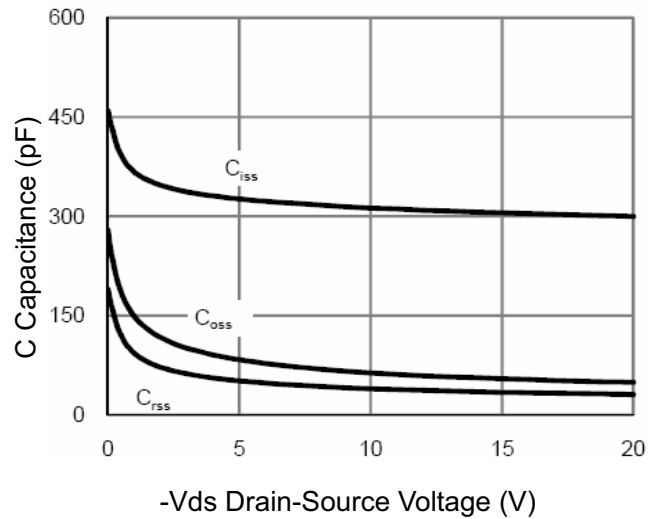

Figure 10 Capacitance vs Vds

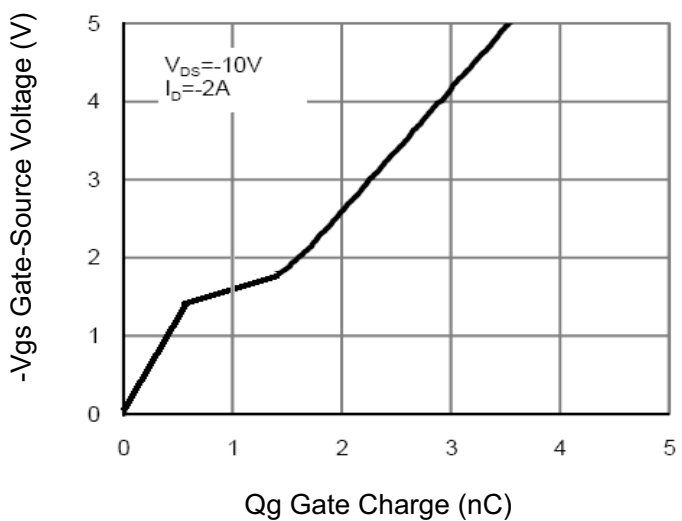

Figure 11 Gate Charge

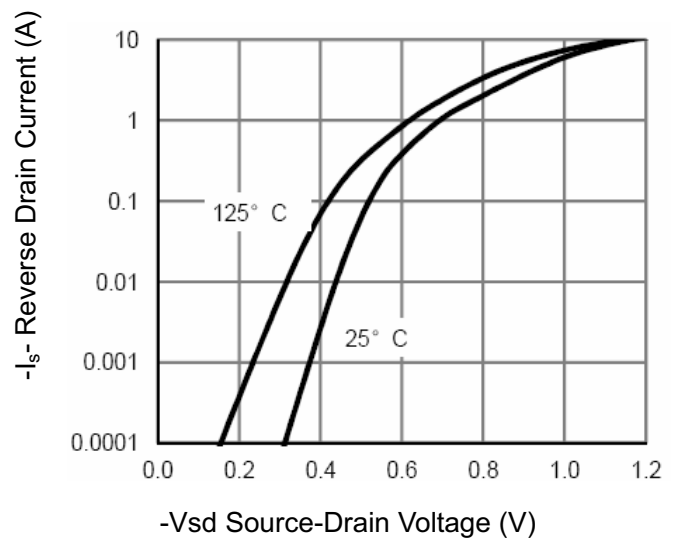

Figure 12 Source- Drain Diode Forward

P- Channel Typical Electrical and Thermal Characteristics (Curves)

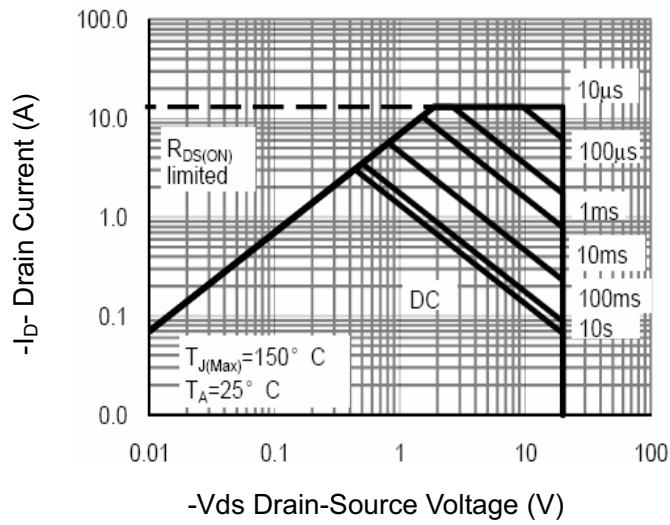

Figure 13 Safe Operation Area

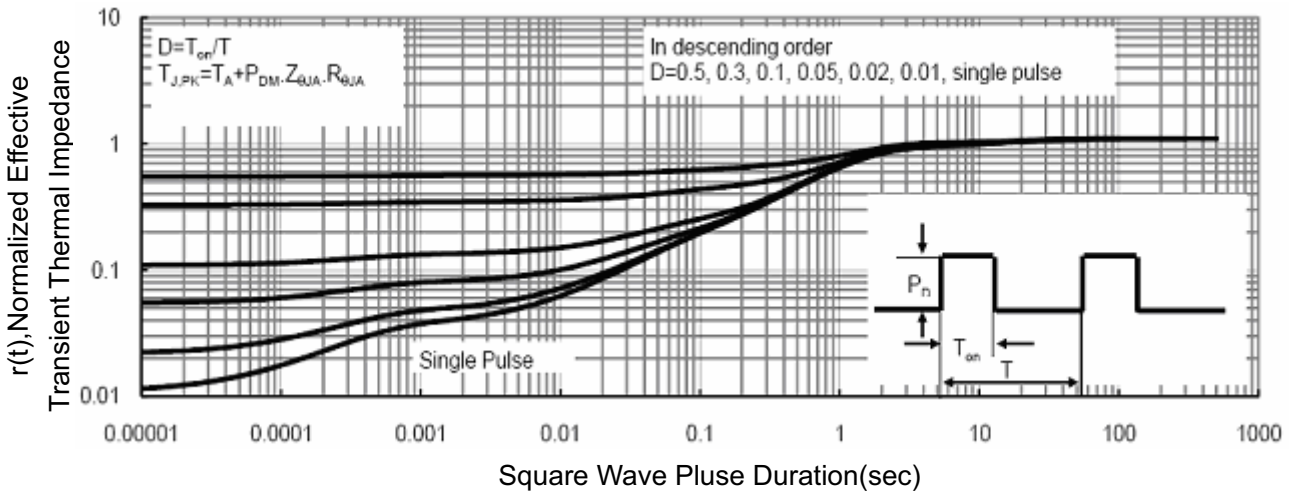
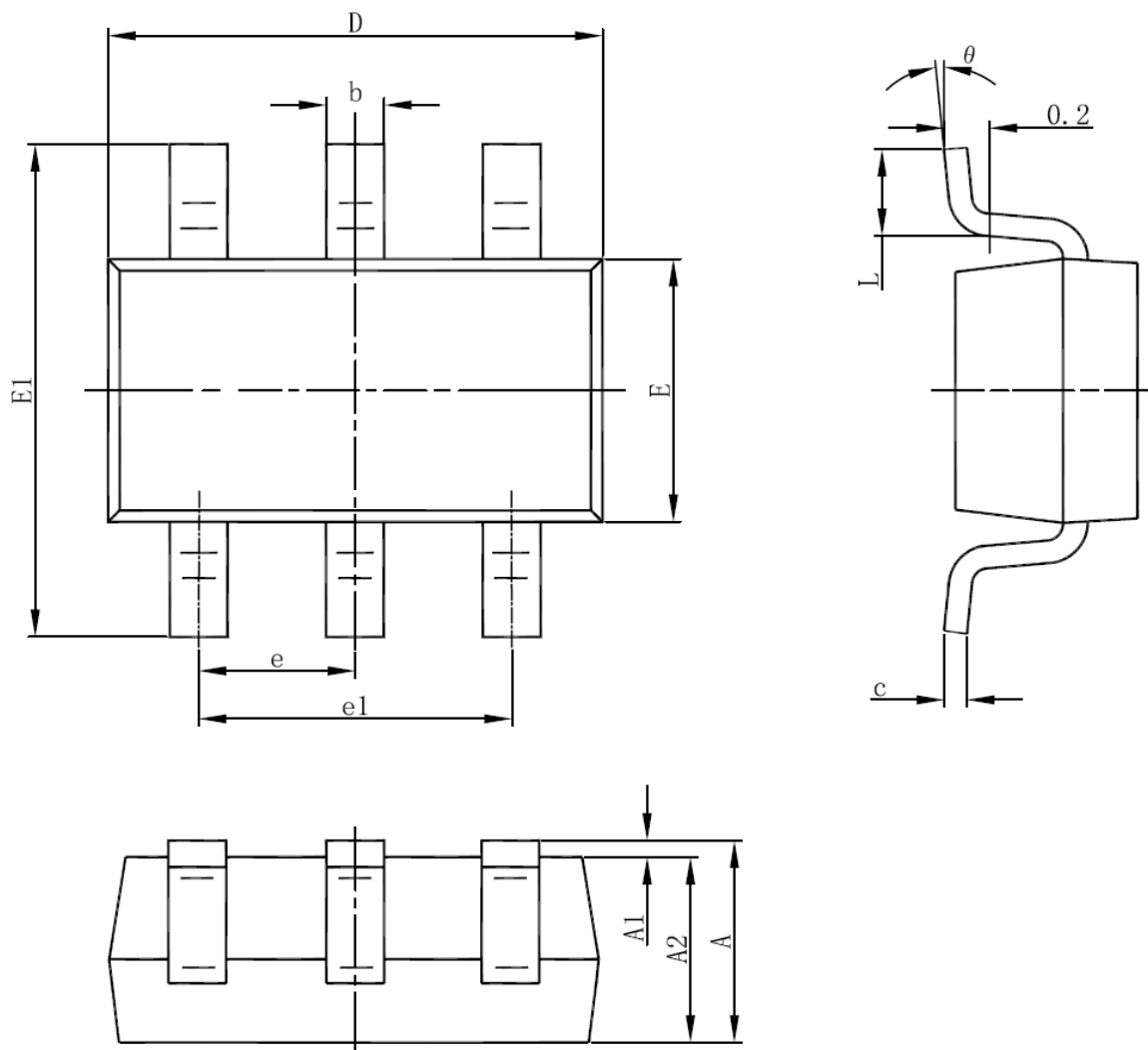

Figure 14 Normalized Maximum Transient Thermal Impedance

SOT23-6L Package Information



Symbol	Dimensions In Millimeters		Dimensions In Inches	
	Min	Max	Min	Max
A	1.050	1.250	0.041	0.049
A1	0.000	0.100	0.000	0.004
A2	1.050	1.150	0.041	0.045
b	0.300	0.500	0.012	0.020
c	0.100	0.200	0.004	0.008
D	2.820	3.020	0.111	0.119
E	1.500	1.700	0.059	0.067
E1	2.650	2.950	0.104	0.116
e	0.950(BSC)		0.037(BSC)	
e1	1.800	2.000	0.071	0.079
L	0.300	0.600	0.012	0.024
θ	0°	8°	0°	8°

Package	Tube (pcs/tube)	Tube (pcs/inner box)	Tube (pcs/cartoon)	Tape&Reel (pcs/reel)	Tape&Reel (pcs/inner box)	Tape&Reel (pcs/cartoon)
DFN5x6/DFN3x3	100	10,000	100,000	2,500	5,000	40,000
DFN1006	—	—	—	10,000	10,000	400,000
SOP-8	100	10,000	100,000	4,000	4,000	20,000
TSSOP-8	100	32,000	128,000	3,000	6,000	48,000
SOT-23-3L	—	—	—	3,000	30,000	120,000
SOT-23-6L	—	—	—	3,000	30,000	120,000
SOT-23(6R)	—	—	—	3,000	30,000	120,000
SOT-363	—	—	—	3,000	30,000	120,000
SOT-523	—	—	—	3,000	30,000	120,000
SOT223	—	—	—	2,500	2,500	20,000
TO-220	50	1,000	5,000	—	—	—
TO-220F	50	1,000	10,000	—	—	—
TO-247	30	300	1,200	—	—	—
TO-251	80	4,000	40,000	—	—	—
TO-251S(4R)	80	4,000	40,000	—	—	—
TO-252-2L(4R)	80	4,000	40,000	2,500	2,500	25,000
TO-263-2L	50	1,000	10,000	800	800	8,000
TO-3P	30	300	3,000	—	—	—
TO-92	—	—	—	1,000(袋装)	10,000	100,000

DISCLAIMER NOTICE

Rectron Inc reserves the right to make changes without notice to any product specification herein, to make corrections, modifications, enhancements or other changes. Rectron Inc or anyone on its behalf assumes no responsibility or liability for any errors or inaccuracies. Data sheet specifications and its information contained are intended to provide a product description only. "Typical" parameters which may be included on RECTRON data sheets and/ or specifications can and do vary in different applications and actual performance may vary over time. Rectron Inc does not assume any liability arising out of the application or use of any product or circuit.

Rectron products are not designed, intended or authorized for use in medical, life-saving implant or other applications intended for life-sustaining or other related applications where a failure or malfunction of component or circuitry may directly or indirectly cause injury or threaten a life without expressed written approval of Rectron Inc. Customers using or selling Rectron components for use in such applications do so at their own risk and shall agree to fully indemnify Rectron Inc and its subsidiaries harmless against all claims, damages and expenditures.