

GPI65008DF68

N-channel 650V8A GaN Power HEMT in 6X8 DFN package

Datasheet version: 1.2 Preliminary

Features

BV_{dss}	R_{dson}	I_{ds}	Q_g
650 V	170 mΩ	8A	2.1 nC

- Ultra-low $R_{DS(on)}$
- High dv/dt capability
- Extremely low input capacitance
- Zero Q_{rr}
- Outstanding switching performance
- Low Profile

Applications

- Switching Power Applications
- Adapters, Quick Chargers

Description

These devices are N-channel 650 V Power GaN HEMTs based on proprietary E-mode GaN on silicon technology. The resulting product has extremely low on state resistance, very low input capacitance and zero reverse recovery charge making it especially suitable for applications which require superior power density, ultra-high switching frequency and outstanding efficiency.

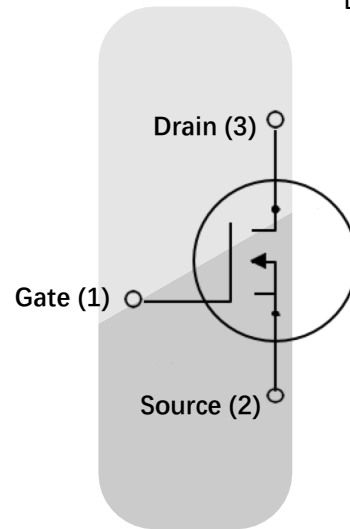
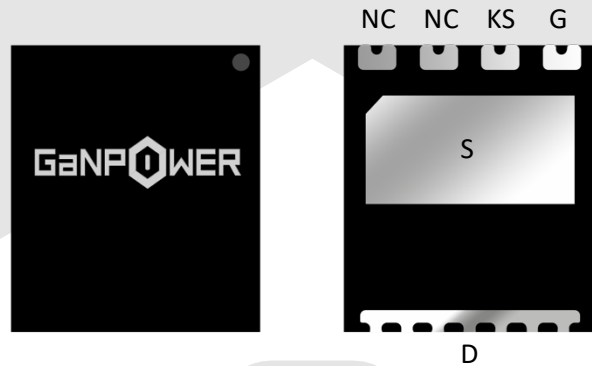



GaNPower International Inc.

WWW.IGANPOWER.COM
 230 -3410 LOUGHEED HWY
 VANCOUVER, BC, V5M 2A4 CANADA

Device Characteristics

Static Parameters				Test data			
	Parameters		Conditions	Min	Typical	Max	Unit
1	$V_{gs(TH)}$	Gate threshold voltage	$V_{ds}=V_{gs}$ $I_d=3.5mA$	1.0	1.4	1.7	V
2	BV_{dss}	Drain-Source breakdown voltage	$V_{gs}=0V$ $I_d=25\mu A$		650	900	V
3	I_{dss}	Zero gate voltage drain current, $T_c = 25C^\circ$	$V_{gs}=0V$ $V_{ds}=650V$		0.35	25	μA
4	I_{gss}	Gate-Source Leakage	$V_{gs} = 6V$ $V_{ds} = 0V$		20	80	μA
5	R_{dson}	Static drain-source on resistance, $T_c = 25C^\circ$	$V_{gs}=6V$ $I_d=2.5A$		170	190	$m\Omega$
6	V_{sd}	Reverse conduction voltage	$I_{sd}=1A$ $V_{gs}=0V$	1.65	1.8	2.2	V
Dynamic Parameters				Test data			
	Parameters		Conditions	Min	Typical	Max	Unit
1	C_{iss}	Input capacitance	$V_{gs}=0V$ $V_{ds}=400V$ $f=1MHz$		63		pf
	C_{oss}	Output capacitance			18		pf
	C_{rss}	Reverse transfer capacitance			0.6		pf
3	Q_g	Gate charge	$V_{ds}=400V$		2.1		nC
	Q_{gs}	Gate to source charge	$I_d=9A$		0.4		nC
	Q_{gd}	Gate to drain charge	$V_{gs}=6V$		0.52		nC
2	Q_{rr}	Reverse recovery charge			0		nC
Switching Performance				Test data			
	Parameters		Conditions	Min	Typical	Max	Unit
1	$t_{d(on)}$	Turn-on delay time	$V_{ds}=400V$ $I_d=2.5A$ $R_g=10\Omega$ $V_{gs}=6V$		4		ns
2	t_r	Rise time			8		ns
3	$t_{d(off)}$	Turn-off delay time			14		ns
4	t_f	Fall time			8		ns



GaNPower International Inc.

WWW.IGANPOWER.COM
230 -3410 LOUGHEED HWY
VANCOUVER, BC, V5M 2A4 CANADA

Absolute Max. Ratings

	Symbols	Parameters	Value	Unit
1	V_{DS-max}	Breakdown voltage transient @ $T_{case}=25^{\circ}C$	800	V
2	V_{GS-max}	Gate to source max. transient voltage @ $T_{case}=25^{\circ}C$	-12 to +7.5	V
3	I_{ds-max}	Drain to source DC current @ $T_{case}=25^{\circ}C$	8	A
4	I_{ds-max}	Drain to source DC current @ $T_{case}=100^{\circ}C$	6	A
5	dv/dt_{-max}	Drain to source voltage slew rate	200	V/nS
6	T_{J-max}	Max junction temperature	150	$^{\circ}C$
7	$T_{S-storage}$	Storage temperature	-55 to 150	$^{\circ}C$

Thermal and Soldering Characteristics (Typical)

	Symbols	Parameters	Value	Unit
1	R_{thJC}	Thermal resistance (junction to case)	2.2	$^{\circ}C/W$
2	R_{thJA}	Thermal resistance (junction to ambient)	62	$^{\circ}C/W$
3	T_{solder}	Reflow soldering temperature	250	$^{\circ}C$

Ordering

Order Code	Package Type	Packaging Method	Qty
GPI65008DF56	DFN surface mount, bottom cooled, 5X6 mm	Tape and Reel	3500

Electrical Performance

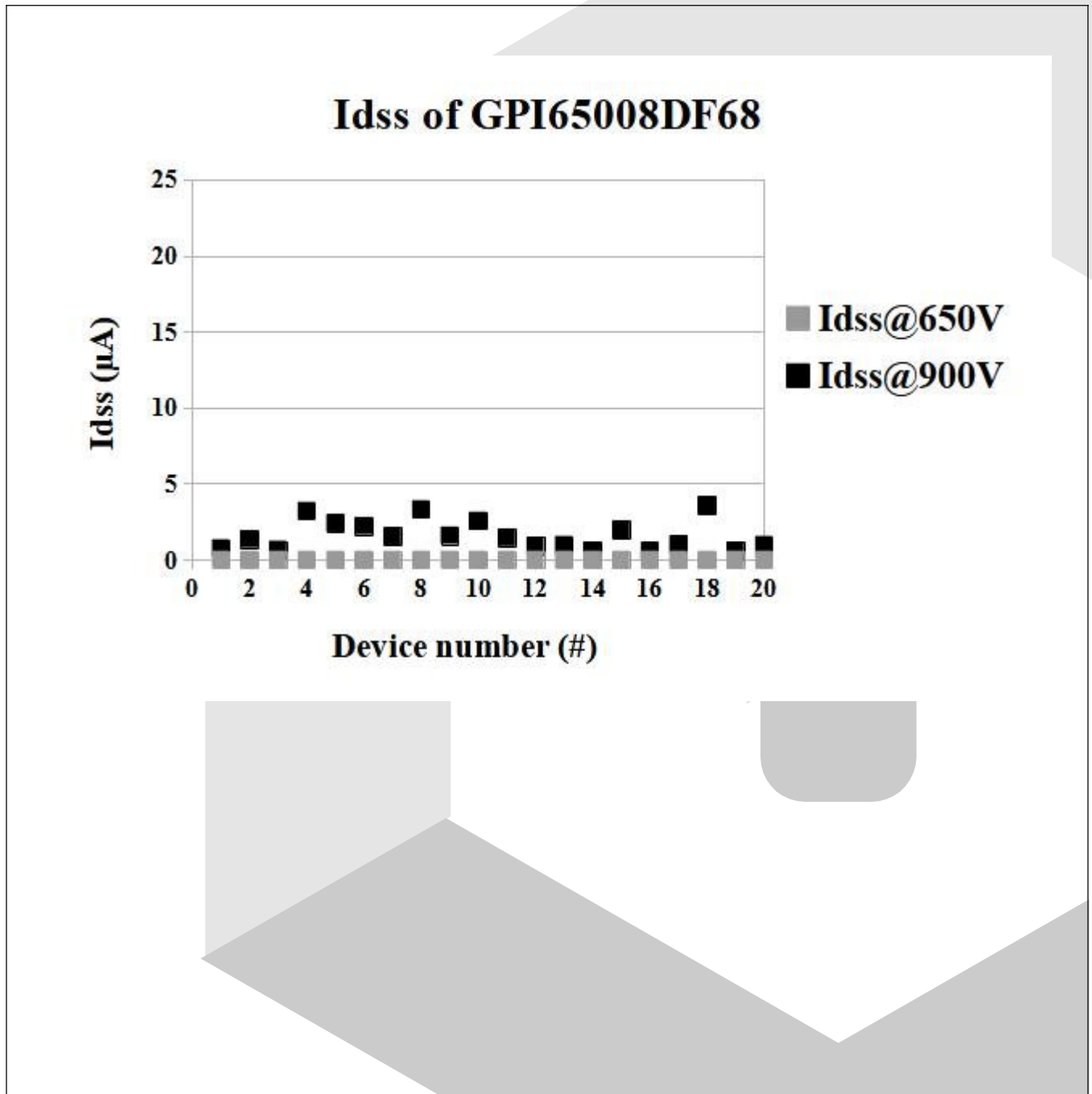

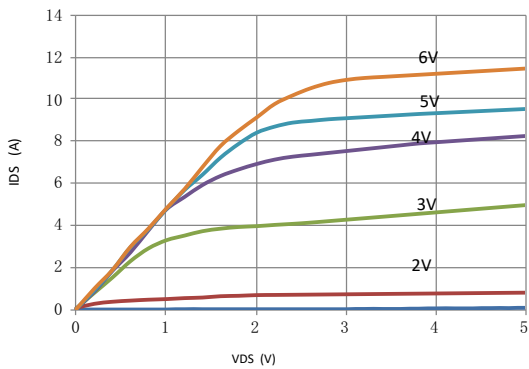

$I_{ds} - V_{ds}$ curves @ 25 °C

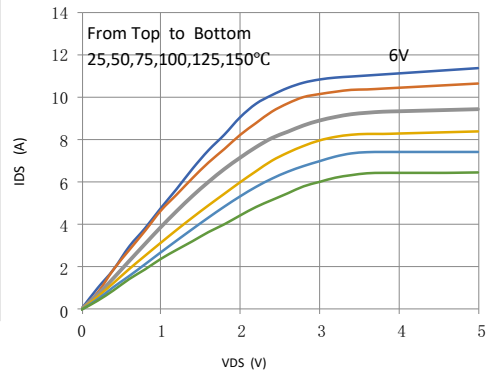

$I_{ds} - V_{ds}$ curves @ $V_{gs}=6V$ & different Temperatures

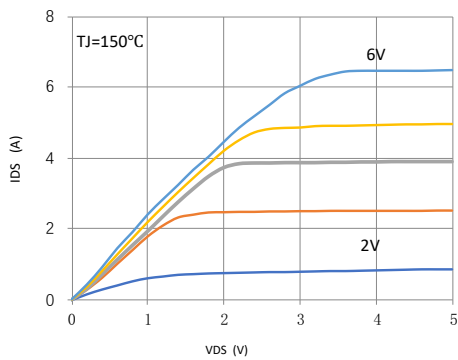

$I_{ds} - V_{ds}$ curves @ 150 °C

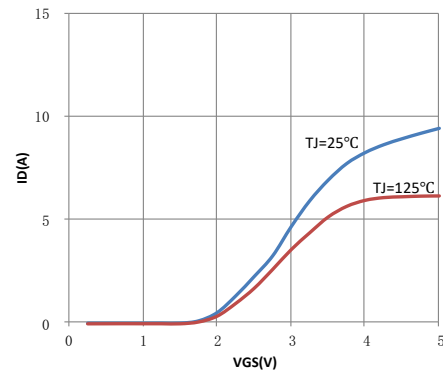

$I_{ds} - V_{gs}$ transfer curves @ 25 °C and 125 °C

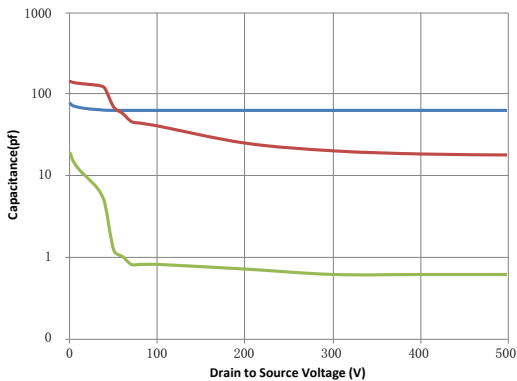

Capacitance

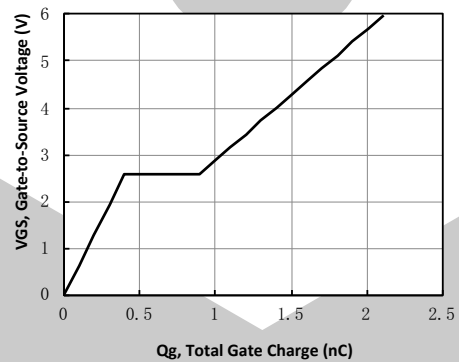

$Q_g - V_{gs}$ curve



GaNPower International Inc.

WWW.IGANPOWER.COM
230 -3410 LOUGHEED HWY
VANCOUVER, BC, V5M 2A4 CANADA

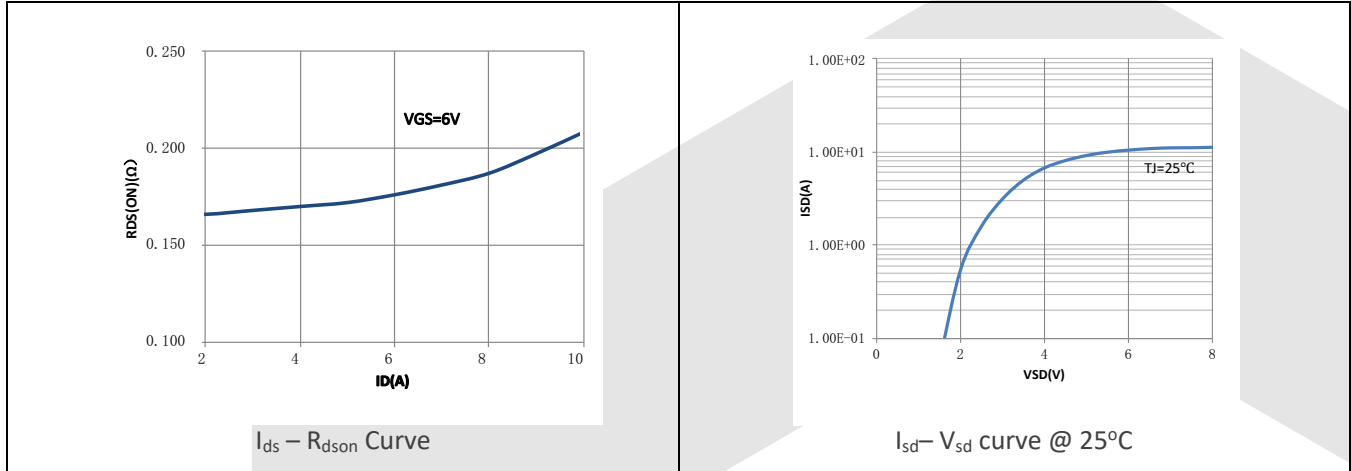

Package Information

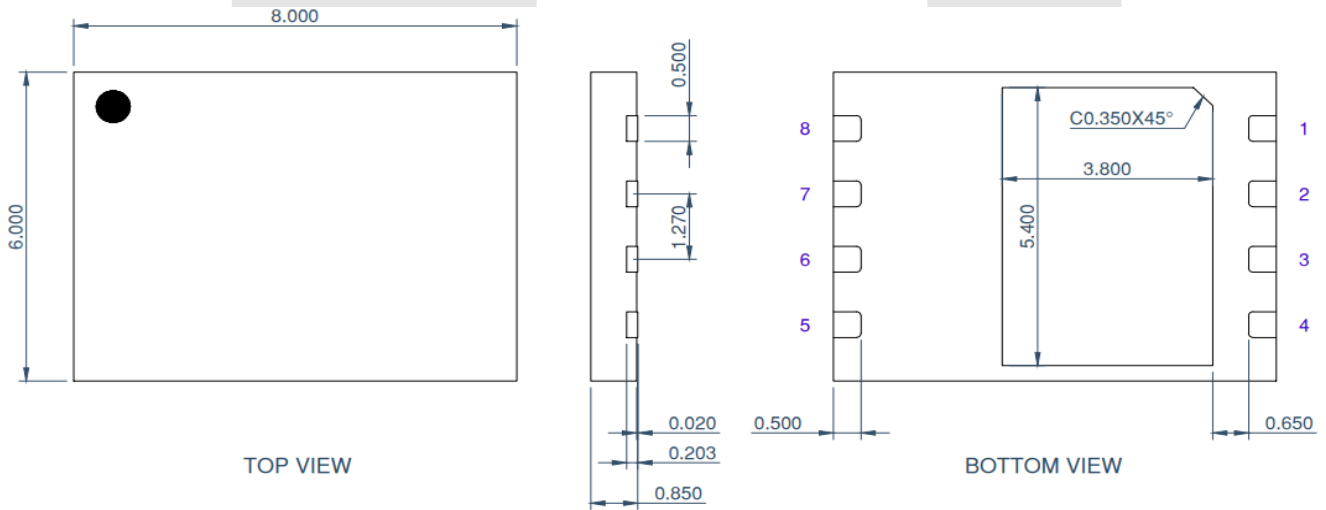

PKG nom. thickness : 0.85mm (Y type)
LF THICKNESS : 0.203±0.008 THK



GaNPower International Inc.

WWW.IGANPOWER.COM
230 -3410 LOUGHEED HWY
VANCOUVER, BC, V5M 2A4 CANADA

GaN HEMT Frequently Asked Questions

1	<p>Q: Can we do pin to pin switch for silicon MOSFET or IGBT?</p> <p>A: The short answer is no. GaN HEMT power devices are far superior than the best silicon devices such as super junction MOSFETs. However, due to different requirements of gate driving voltage and extremely high dv/dt rate, special drivers and optimized PCB layouts are recommended to minimize the impact from circuit parasitics. Some packaging forms such as GaNPower's DFN packaged devices offer both sense and force for the source terminal. Also, for traditional TO220 packages, please be advised that the pins are arranged as Gate – Source -Drain, and the thermal pad is connected to the source instead of drain.</p>
2	<p>Q: Are GaN power devices reliable?</p> <p>A: GaN power HEMTs have been tested by GaNPower and many other vendors, users and testing facilities to be as reliable (if not better than) silicon counterparts.</p>
3	<p>Q: How do GaN power devices compare with SiC?</p> <p>A: Currently GaN power HEMT devices are most suitable for low to medium voltage ($\leq 1200V$) and power (<20KW) applications. GaN is the ideal choice for high frequency applications. SiC devices are better choice for high voltage and high-power applications (>20KW).</p>
4	<p>Q: Do we need to parallel an FRD for applications such as inverters?</p> <p>A: GaN devices are different from silicon MOSFET or IGBT in that they have no inherent PN junction diodes that cause reverse recovery issue. User do not need to parallel an FRD for the purpose of suppressing the body diode reverse recovery effect, since GaN HEMT can operate in both first and third quadrants. However, care should be taken for the dead time power loss since the Vsd voltage of GaN HEMT is usually close to 2V. This is especially true when a negative gate voltage is applied.</p>
6	<p>Q: Can we parallel GaN HEMT devices?</p> <p>A: Yes, GaN HEMT is ideal for paralleling, due to positive temperature coefficient of Rdson and slightly positive temperature coefficient of threshold voltage.</p>
5	<p>Q: Where can we find drivers for GaNPower HEMT devices?</p> <p>A: While some of the GaNPower's HEMTs are either monolithically integrated with gate driver or co-packaged with a silicon driver, drivers can be easily found from vendors such as TI and Silicon Lab for either single sided or half-bridge configurations:</p> <ul style="list-style-type: none">✓ TI: LM5114: Single 7.6A Peak Current Low-Side Gate Driver✓ TI: UCC27611: 5V, 4A/6A Low Side GaN Driver✓ Maxim: MAX5048C: 7A Sink/3A Source Current, 8ns, SOT23, MOSFET Drive✓ Fairchild: FAN3122: Single 9-A High-Speed, Low-Side Gate Driver✓ Silicon Lab: Si827X: 4 Amp ISO driver with High Transient (dv/dt) Immunity