

CGA4C2C0G1H682J060AD

TDK Item Description : CGA4C2C0G1H682JT***B



Equivalent C2012C0G1H682J for Automotive

Application & Main Feature

Automotive Grade (Conductive Epoxy Application)

Series

CGA4(2012) [EIA 0805]

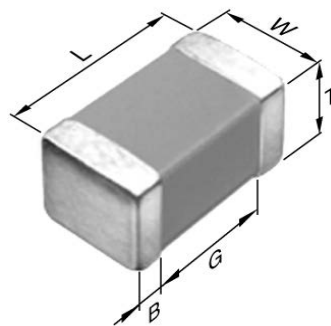

Dimensions

L	2.00mm ±0.25mm
W	1.25mm ±0.25mm
T	0.60mm ±0.15mm
B	0.20mm Min.
G	0.50mm Min.

Temperature Characteristic

C0G (-55 to 125 degC 0+/-30ppm/degC)

Rated Voltage

1H(50Vdc)

Capacitance

6.8nF

Capacitance Tolerance

J (±5%)

Q Factor

1000 Min.

Insulation Resistance

10Gohm Min

AEC-Q200

Yes

DC Bias Characteristic

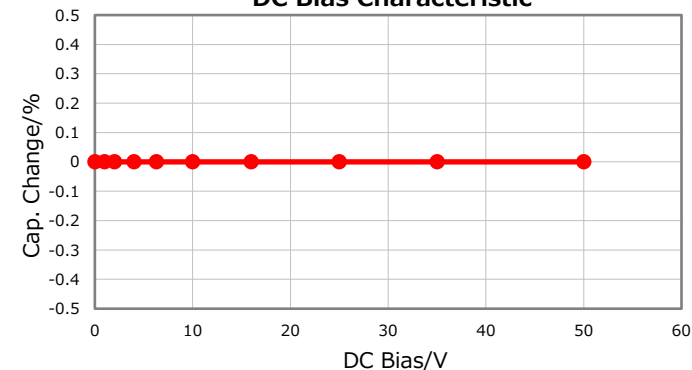

|Z|, ESR vs. Freq. Characteristics

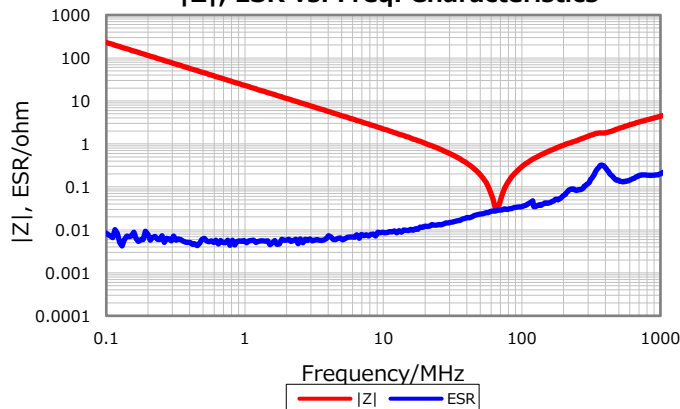

Temperature Characteristics

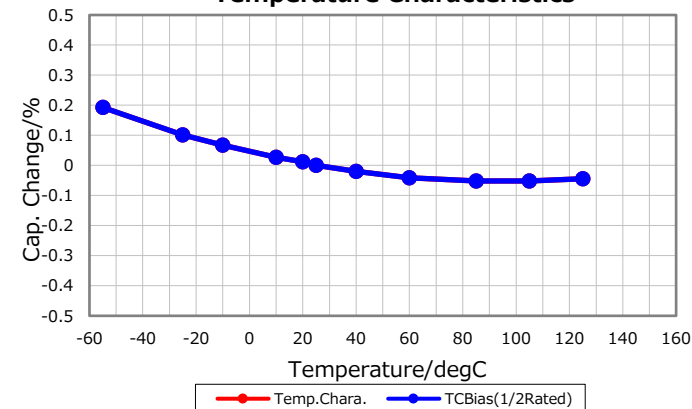

Cap. vs. Freq. Characteristic

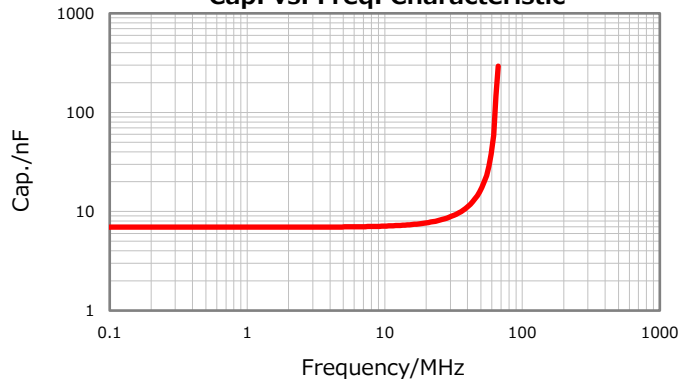

Ripple Temperature Rise Characteristics

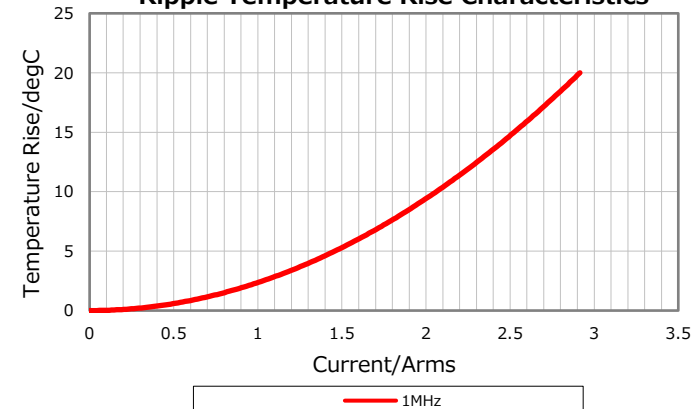

Characterization Sheet (Multilayer Ceramic Chip Capacitors)



All specifications are subject to change without notice.

May 22, 2019