

Data sheet | Item number: 857-820

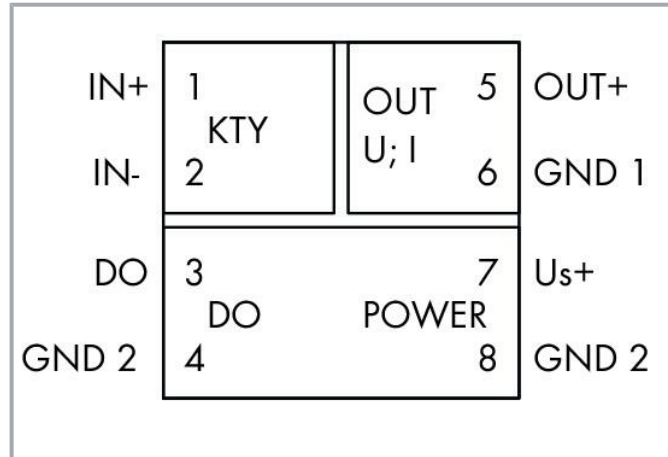

Temperature signal conditioner for KTY sensors; Current and voltage output signal; Configuration via DIP switch; Supply voltage: 24 VDC; 6 mm module width; light gray

www.wago.com/857-820

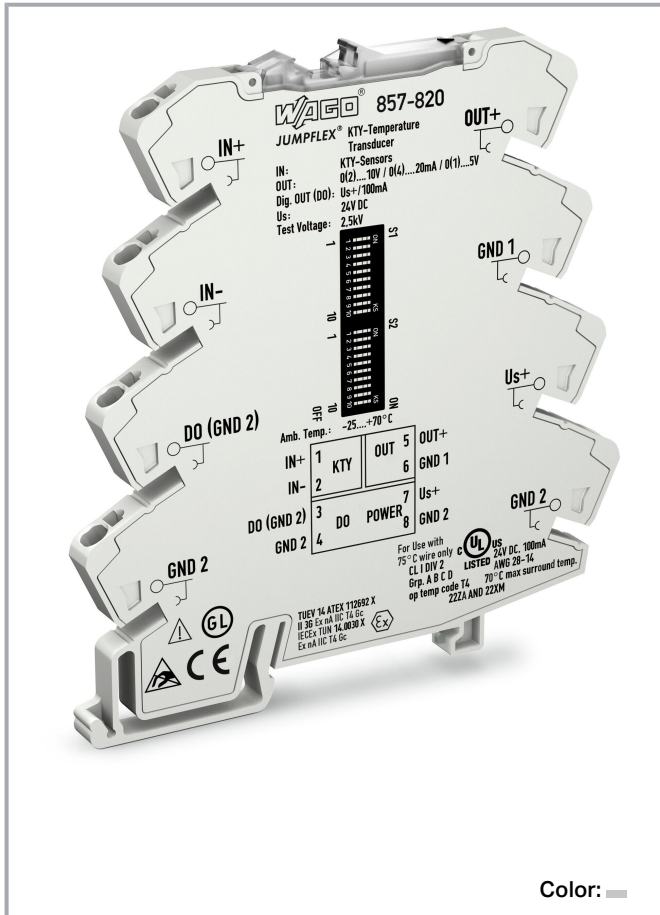

Subject to changes. Please also observe the further product documentation!

WAGO GmbH & Co. KG
Hansastr. 27
32423 Minden
Phone: +49571 887-0 | Fax: +49571 887-169
Email: info.de@wago.com | Web: www.wago.com

Do you have any questions about our products?
We are always happy to take your call at +49 (571) 887-44222.



Input (KTY sensors)

Sensor types (KTY)	KTY81-110 KTY81-120 KTY81-121 KTY81-122 KTY81-150 KTY81-210 KTY81-220 KTY81-221 KTY81-222 KTY81-250 KTY82-110 KTY82-120 KTY82-121 KTY82-122 KTY82-150 KTY82-220 KTY82-221 KTY82-222 KTY82-250 KTY83-110 KTY83-120 KTY83-121 KTY83-122 KTY83-150 KTY83-151 KTY84-130 KTY84-150 KTY84-151 KTY16 KTY19 ST13 ST20
--------------------	--

Sensor connection	2-wire
-------------------	--------

Output (analog)

Output signal type	Current Voltage
Output signal (voltage)	0 ... 5 V; 1 ... 5 V; 0 ... 10 V; 2 ... 10 V
Output signal (current)	0 ... 10 mA; 2 ... 10 mA; 0 ... 20 mA; 4 ... 20 mA
Load impedance (voltage output)	$\geq 2 \text{ k}\Omega$
Load impedance (current output)	$\leq 600 \Omega$

Subject to changes. Please also observe the further product documentation!



Output (digital)

Switching voltage (DO) max.	Supply voltage applied
Continuous current (DO) max.	100 mA (no internal restriction)

Signal Processing

Step response (typ.)	50 ms
----------------------	-------

Measurement Error

Transmission error (typ.)	≤ 0.1 % of upper-range value
---------------------------	------------------------------

Supply

Power supply type	24 VDC
Nominal supply voltage U_S	DC 24 V
Supply voltage range	±30 %
Current consumption at nominal supply voltage	≤ 40 mA (+ I_{DO})

Safety and protection

Protection type	IP20
-----------------	------

Test voltage

Test voltage (input/output/supply)	AC 2.5 kV; 50 Hz; 1 min
------------------------------------	-------------------------

Connection data

Connection technology	Push-in CAGE CLAMP®
Solid conductor	0.08 ... 2.5 mm ² / 28 ... 14 AWG
Fine-stranded conductor	0.34 ... 2.5 mm ² / 22 ... 14 AWG
Strip length	9 ... 10 mm / 0.35 ... 0.39 inches

Physical data

Width	6 mm / 0.236 inches
Height	94 mm / 3.701 inches
Depth from upper-edge of DIN-rail	97.8 mm / 3.85 inches

Subject to changes. Please also observe the further product documentation!

WAGO GmbH & Co. KG
 Hansastr. 27
 32423 Minden
 Phone: +49571 887-0 | Fax: +49571 887-169
 Email: info.de@wago.com | Web: www.wago.com

Do you have any questions about our products?
 We are always happy to take your call at +49 (571) 887-44222.



Mechanical Data

Mounting type	DIN-35 rail
---------------	-------------

Material Data

Color	light gray
Fire load	0.418 MJ
Weight	35.5 g

Environmental requirements

Ambient temperature (operation)	-25 ... +70 °C
Ambient temperature (storage)	-40 ... +85 °C
Relative humidity	5 ... 95 % (no condensation permissible)
Operating altitude (max.)	2000 m

Standards and specifications

Conformity marking	CE
EMC immunity to interference	EN 61000-6-2
EMC emission of interference	EN 61000-6-4
Standards/specifications	DNV

Commercial data

Product Group	6 (INTERFACE ELECTRONIC)
eCl@ss 10.0	27-21-01-29
eCl@ss 9.0	27-21-01-20
ETIM 8.0	EC002919
ETIM 7.0	EC002919
PU (SPU)	1 pcs
Packaging type	bag
Country of origin	DE
GTIN	4050821053002
Customs tariff number	85437090300

Environmental Product Compliance



CAS-No.	7439-92-1 79-94-7
---------	----------------------

Subject to changes. Please also observe the further product documentation!

REACH Candidate List Substance	2,2',6,6'-tetrabromo-4,4'-isopropylidenediphenol Lead
RoHS Compliance Status	Compliant,With Exemption
RoHS Exemption	6(c) 7(a) 7(c)-I 7(c)-II
SCIP notification number (Austria)	34941bc9-8e48-46c9-a7b2-4825f5329246
SCIP notification number (Belgium)	75a377f0-35a3-4b2e-b165-bce77bd274cc
SCIP notification number (Bulgaria)	5cf1a5be-e025-43b0-825a-1b18a8f7f565
SCIP notification number (Czech Republic)	bdb21d8c-e1b4-4b2d-9bfa-0c6300dbc530
SCIP notification number (Denmark)	095db8cb-41af-4e82-af2d-44fdbf1dd68e
SCIP notification number (Finland)	cc1af7e7-ac8e-4237-9b82-3be1333c8700
SCIP notification number (France)	2c3fa22b-66cf-465e-924f-b8524df6b7d3
SCIP notification number (Germany)	4e95591a-ceaf-4f18-a2eb-555acfd521ee
SCIP notification number (Hungary)	40a070aa-3e73-4134-802a-93e9ee82407c
SCIP notification number (Italy)	8848a2d7-75d7-4e9e-9370-a97d25b26a7c
SCIP notification number (Netherlands)	e1443cd2-bc18-43af-bdba-091fbfcb17ce
SCIP notification number (Poland)	f67dea86-39d8-4962-9e6f-233cd0e10f47
SCIP notification number (Romania)	0d661d8e-e744-421d-ab87-6acc1b302ed5
SCIP notification number (Sweden)	9854cc75-067c-44e6-9b84-fc9b27e877de

Approvals / Certificates

General approvals

Logo	Approval	Additional Approval Text	Certificate name
	CCC CNEX	CNCA-C23-01	2020312310000210 (Ex ec IIC T4 Gc)
	EAC Brjansker Zertifizierungsstelle	TP TC 020/2011	EAC_Certificate_RU_C- DE.AM02.B.00115_19

Declarations of conformity and manufacturer's declarations



Logo	Approval	Additional Approval Text	Certificate name
	EU-Declaration of Conformity WAGO GmbH & Co. KG	-	-

Subject to changes. Please also observe the further product documentation!







WAGO GmbH & Co. KG
Hansastr. 27
32423 Minden
Phone: +49571 887-0 | Fax: +49571 887-169
Email: info.de@wago.com | Web: www.wago.com

Do you have any questions about our products?
We are always happy to take your call at +49 (571) 887-44222.

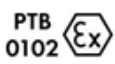
Approvals for marine applications

Logo	Approval	Additional Approval Text	Certificate name
	BV Bureau Veritas S.A.	Rules for class. of Steel Ships	40179_B0
	DNV DNV Germany GmbH	DNV-CG-0339, Aug. 2021	TAA00001D1
	PRS Polski Rejestr Statków	-	TE/2186 /880590/18

Approvals for hazardous areas

Logo	Approval	Additional Approval Text	Certificate name
	ATEX TUEV Nord Cert GmbH	EN 60079-0	TÜV_14_ATEX_112692_X (II 3 G Ex nA IIC T4 Gc)
	CCC CNEX	CNCA-C23-01	2020312310000210 (Ex ec IIC T4 Gc)
	EAC Brjansker Zertifizierungsstelle	TP TC 012/2011	EAC RU C-DE.AM02.B. 00144/19 (2 Ex nA IIC T4 Gc X)
	IECEX TUEV Nord Cert GmbH	IEC 60079-0	IECEX_TUN_14.0030_X
	UKEx WAGO GmbH & Co. KG	EN 60079-0	WAGO22UKEX004X
	UL Underwriters Laboratories Inc. (HAZARDOUS LOCATIONS)	ANSI/ISA 12.12.01	E198726













Subject to changes. Please also observe the further product documentation!

WAGO GmbH & Co. KG
Hansastr. 27
32423 Minden
Phone: +49571 887-0 | Fax: +49571 887-169
Email: info.de@wago.com | Web: www.wago.com











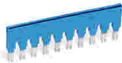

Do you have any questions about our products?
We are always happy to take your call at +49 (571) 887-44222.

Optional accessories











Jumpers

Jumper		
	Item no.: 859-408 Jumper; for jumper slot; 8-way; insulated; light gray	www.wago.com/859-408
	Item no.: 281-482 Jumper; 2-way; insulated; gray	www.wago.com/281-482
	Item no.: 859-404/000-005 Jumper; for jumper slot; 4-way; insulated; red	www.wago.com/859-404/000-005
	Item no.: 859-404/000-006 Jumper; for jumper slot; 4-way; insulated; blue	www.wago.com/859-404/000-006
	Item no.: 859-405/000-005 Jumper; for jumper slot; 5-way; insulated; red	www.wago.com/859-405/000-005
	Item no.: 859-405/000-029 Jumper; for jumper slot; 5-way; insulated; yellow	www.wago.com/859-405/000-029
	Item no.: 859-405 Jumper; for jumper slot; 5-way; insulated; light gray	www.wago.com/859-405
	Item no.: 859-404/000-029 Jumper; for jumper slot; 4-way; insulated; yellow	www.wago.com/859-404/000-029
	Item no.: 859-406 Jumper; for jumper slot; 6-way; insulated; light gray	www.wago.com/859-406
	Item no.: 859-405/000-006 Jumper; for jumper slot; 5-way; insulated; blue	www.wago.com/859-405/000-006
	Item no.: 859-406/000-005 Jumper; for jumper slot; 6-way; insulated; red	www.wago.com/859-406/000-005
	Item no.: 859-409/000-029 Jumper; for jumper slot; 9-way; insulated; yellow	www.wago.com/859-409/000-029



Subject to changes. Please also observe the further product documentation!

	Item no.: 859-410/000-005 Jumper; for jumper slot; 10-way; insulated; red	www.wago.com/859-410/000-005
	Item no.: 859-410/000-029 Jumper; for jumper slot; 10-way; insulated; yellow	www.wago.com/859-410/000-029
	Item no.: 859-410 Jumper; for jumper slot; 10-way; insulated; light gray	www.wago.com/859-410
	Item no.: 859-410/000-006 Jumper; for jumper slot; 10-way; insulated; blue	www.wago.com/859-410/000-006
	Item no.: 859-403/000-005 Jumper; for jumper slot; 3-way; insulated; red	www.wago.com/859-403/000-005
	Item no.: 859-402/000-029 Jumper; for jumper slot; 2-way; insulated; yellow	www.wago.com/859-402/000-029
	Item no.: 859-403/000-029 Jumper; for jumper slot; 3-way; insulated; yellow	www.wago.com/859-403/000-029
	Item no.: 859-403/000-006 Jumper; for jumper slot; 3-way; insulated; blue	www.wago.com/859-403/000-006
	Item no.: 859-408/000-005 Jumper; for jumper slot; 8-way; insulated; red	www.wago.com/859-408/000-005
	Item no.: 859-408/000-029 Jumper; for jumper slot; 8-way; insulated; yellow	www.wago.com/859-408/000-029
	Item no.: 859-409 Jumper; for jumper slot; 9-way; insulated; light gray	www.wago.com/859-409
	Item no.: 859-408/000-006 Jumper; for jumper slot; 8-way; insulated; blue	www.wago.com/859-408/000-006
	Item no.: 859-403 Jumper; for jumper slot; 3-way; insulated; light gray	www.wago.com/859-403
	Item no.: 859-409/000-005 Jumper; for jumper slot; 9-way; insulated; red	www.wago.com/859-409/000-005

Subject to changes. Please also observe the further product documentation!

	Item no.: 859-404 Jumper; for jumper slot; 4-way; insulated; light gray	www.wago.com/859-404
	Item no.: 859-409/000-006 Jumper; for jumper slot; 9-way; insulated; blue	www.wago.com/859-409/000-006
	Item no.: 859-402/000-006 Jumper; for jumper slot; 2-way; insulated; blue	www.wago.com/859-402/000-006
	Item no.: 859-402 Jumper; for jumper slot; 2-way; insulated; light gray	www.wago.com/859-402
	Item no.: 859-402/000-005 Jumper; for jumper slot; 2-way; insulated; red	www.wago.com/859-402/000-005
	Item no.: 859-406/000-006 Jumper; for jumper slot; 6-way; insulated; blue	www.wago.com/859-406/000-006
	Item no.: 859-406/000-029 Jumper; for jumper slot; 6-way; insulated; signal yellow	www.wago.com/859-406/000-029
	Item no.: 859-407/000-006 Jumper; for jumper slot; 7-way; insulated; blue	www.wago.com/859-407/000-006
	Item no.: 859-407/000-005 Jumper; for jumper slot; 7-way; insulated; red	www.wago.com/859-407/000-005
	Item no.: 859-407/000-029 Jumper; for jumper slot; 7-way; insulated; yellow	www.wago.com/859-407/000-029
	Item no.: 859-407 Jumper; for jumper slot; 7-way; insulated; light gray	www.wago.com/859-407

Marking accessories

Marking strip		
	Item no.: 2009-110 Marking strips; for Smart Printer; on reel; not stretchable; plain; snap-on type; white	www.wago.com/2009-110
Marker		
	Item no.: 2009-115 WMB-Inline; for Smart Printer; 1500 pieces on roll; stretchable 5 - 5.2 mm; plain; snap-on type; white	www.wago.com/2009-115

Subject to changes. Please also observe the further product documentation!

**Item no.: 793-501**

WMB marking card; as card; not stretchable; plain; snap-on type; white

www.wago.com/793-501**Item no.: 793-502**

WMB marking card; as card; MARKED; 1 ... 10 (10x); not stretchable; Horizontal marking; snap-on type; white

www.wago.com/793-502**Item no.: 793-503**

WMB marking card; as card; MARKED; 11 ... 20 (10x); not stretchable; Horizontal marking; snap-on type; white

www.wago.com/793-503**Item no.: 793-504**

WMB marking card; as card; MARKED; 21 ... 30 (10x); not stretchable; Horizontal marking; snap-on type; white

www.wago.com/793-504**Item no.: 793-505**

WMB marking card; as card; MARKED; 31 ... 40 (10x); not stretchable; Horizontal marking; snap-on type; white

www.wago.com/793-505**Item no.: 793-506**

WMB marking card; as card; MARKED; 41 ... 50 (10x); not stretchable; Horizontal marking; snap-on type; white

www.wago.com/793-506**Item no.: 793-566**

WMB marking card; as card; MARKED; 1 ... 50 (2x); not stretchable; Horizontal marking; snap-on type; white

www.wago.com/793-566**Item no.: 793-5501**

WMB marking card; as card; for terminal block width 5 - 17.5 mm; stretchable 5 - 5.2 mm; plain; snap-on type; white

www.wago.com/793-5501**Power supplies**

Power supply unit

**Item no.: 787-2852**

Switched-mode power supply; 1-phase; 24 VDC output voltage; 1 A output current

www.wago.com/787-2852**Relay module**

Relay module

**Item no.: 857-304**Relay module; Nominal input voltage: 24 VDC; 1 changeover contact; Limiting continuous current: 6 A; Yellow status indicator; Module width: 6 mm; 2,50 mm²; graywww.wago.com/857-304**Interface module**

Interface adapters

**Item no.: 857-980**

Interface adapter; 16-pole; analog

www.wago.com/857-980**Tool**

Operating tool

**Item no.: 210-720**

Operating tool; Blade: 3.5 x 0.5 mm; with a partially insulated shaft; multicoloured

www.wago.com/210-720**Terminal blocks**

Supply module

Subject to changes. Please also observe the further product documentation!

WAGO GmbH & Co. KG

Hansastr. 27

32423 Minden

Phone: +49571 887-0 | Fax: +49571 887-169

Email: info.de@wago.com | Web: www.wago.com

Do you have any questions about our products?

We are always happy to take your call at +49 (571) 887-44222.



Item no.: 857-979

Supply and through module

www.wago.com/857-979

Screwless end stop

Mounting accessories



Item no.: 249-116

Screwless end stop; 6 mm wide; for DIN-rail 35 x 15 and 35 x 7.5; gray

www.wago.com/249-116



Item no.: 249-117

Screwless end stop; 10 mm wide; for DIN-rail 35 x 15 and 35 x 7.5; gray

www.wago.com/249-117



Item no.: 249-197

Screwless end stop; 14 mm wide; for DIN-rail 35 x 15 and 35 x 7.5; gray

www.wago.com/249-197

Downloads

Documentation

Bid Text

857-820 docx - Datei	2019 Feb 20	docx 17.7 kB	Download
857-820 X81 - Datei	2019 Feb 19	xml 5.9 kB	Download

Instruction Leaflet

CCC Ex (Additional information) 857-***	2023 Apr 26	pdf 144.4 kB	Download
Messumformer und Trennverstärker Temperaturmessumformer KTY DIP-Schalter		pdf 1.9 MB	Download

Additional Information

Disposal and Recycling Electrical and electronic equipment, Batteries, Packaging	V 1.1.0 2022 Aug 18	pdf 2.2 MB	Download
---	------------------------	---------------	----------

CAD/CAE-Data

CAD data

2D/3D Models 857-820

Subject to changes. Please also observe the further product documentation!

WAGO GmbH & Co. KG
Hansastr. 27
32423 Minden
Phone: +49571 887-0 | Fax: +49571 887-169
Email: info.de@wago.com | Web: www.wago.com

Do you have any questions about our products?
We are always happy to take your call at +49 (571) 887-44222.

ZUSÄTZLICHE MODELLE 857-820

[URL](#) [Download](#)

CAE data

EPLAN Data Portal 857-820

[URL](#) [Download](#)

WSCAD Universe 857-820

[URL](#) [Download](#)

ZUKEN Portal 857-820

[URL](#) [Download](#)

Environmental Product Compliance

Compliance Search

Environmental Product Compliance 857-820

[URL](#) [Download](#)

Temperature signal conditioner for KTY sensors; Current and voltage output signal; Configuration via DIP switch; Supply voltage: 24 VDC; 6 mm module width; light gray

Installation Notes

Configuring

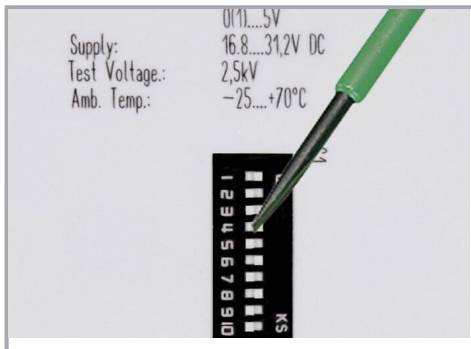

Configuration via DIP switch

Commoning

Subject to changes. Please also observe the further product documentation!

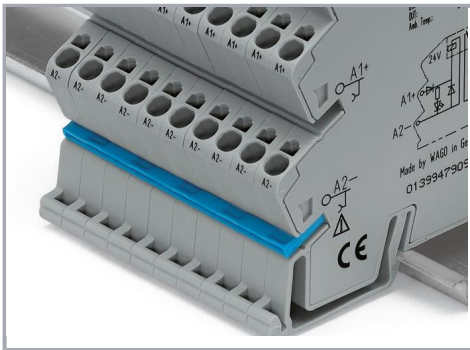

Commoning, not discrete wiring – Same outline allows use of a single in-line, push-in jumper.

Subject to changes. Please also observe the further product documentation!

WAGO GmbH & Co. KG
Hansastr. 27
32423 Minden
Phone: +49571 887-0 | Fax: +49571 887-169
Email: info.de@wago.com | Web: www.wago.com

Do you have any questions about our products?
We are always happy to take your call at +49 (571) 887-44222.