

## Item description

### Female connector/socket WINSTA® MIDI with protection against mismatching

For power and signal transmission: The WINSTA® MIDI female connector/socket with protection against mismatching. Our pluggable installation connectors with spring pressure connection technology work without screw connections. They allow resource-efficient, error-free installation in numerous possible uses. The mechanical coding and color coding of the pluggable installation connector ensure error-free installation of the individual components – including protection against mismatching. The pluggable installation connector offers protection against contact with live components in accordance with protection type IP20 (When mated and secured with a strain relief housing: IP2xC (These compact connectors are not designed for use in open, easily accessible areas!)). The WINSTA® MIDI pluggable installation connector with A coding in white or black is usually used for general mains applications in power distribution. The rated current and voltage are important criteria for selecting a pluggable installation connector: They tell us about the product's domains of use. This product has a current rating of 25 A – so it is suitable for powerful loads. The WINSTA® MIDI Pluggable Connection System with Push-in CAGE CLAMP® spring pressure connection technology facilitates exemplary electrification. Thanks to the integrated test slot, it is possible to check connections even when they are plugged in. This saves time, labor, and money. The strip length is 35 mm.

Subject to changes. Please also observe the further product documentation!



## Push-in CAGE CLAMP® spring pressure connection technology – pluggable installation instead of laborious screw connections!

WINSTA® is the pluggable connection system that is optimally tailored to the strict requirements of electrical installation. It ensures error-free installation of cables and components, quickly and reliably. Choose durability and quality – the WINSTA® MIDI pluggable installation connector with protection against mismatching from WAGO makes the electrical installation of electrical components significantly easier.

- effective protection against mismatching
- pre-assembled versions
- with A coding for a large number of uses
- ready for immediate use
- rapid, structured electrical installation

### Data

#### Electrical data

#### Ratings per IEC/EN

Ratings per	IEC/EN 60664-1
Nominal voltage (III/3)	250 V
Rated impulse voltage (III/3)	4 kV
Rated current	25 A
Legend (ratings)	(III / 3) ± Overvoltage category III / Pollution degree 3

#### Ratings per UL 1977

Note for the US market	Some versions may also be used for current interruption in accordance with the UL certificate in select applications with currents below 16 A and voltages up to 600 V. For further information, please contact your local sales office.
Rated voltage (UL 1977)	600 V
Rated current UL 1977	23 A

### General

Note on contact resistance	approx. 1 mΩ of contact resistance approx. 0.25 mΩ contact transition plug/socket
----------------------------	--

Subject to changes. Please also observe the further product documentation!

WAGO GmbH & Co. KG  
 Hansastr. 27  
 32423 Minden  
 Phone: +49571 887-0 | Fax: +49571 887-169  
 Email: [info.de@wago.com](mailto:info.de@wago.com) | Web: [www.wago.com](http://www.wago.com)

Do you have any questions about our products?  
 We are always happy to take your call at +49 (571) 887-44222.



## Connection data

Connection points	4
Total number of potentials	2

## Connection 1

Connection technology	Push-in CAGE CLAMP®
Actuation type	Operating tool Push-in
Nominal cross-section	4 mm <sup>2</sup> / 12 AWG
Solid conductor	0.5 ... 4 mm <sup>2</sup> / 20 ... 12 AWG
Solid conductor; push-in termination	1.5 ... 4 mm <sup>2</sup> / 16 ... 12 AWG
Stranded conductor	0.5 ... 2.5 mm <sup>2</sup> / 20 ... 14 AWG
Fine-stranded conductor	0.5 ... 4 mm <sup>2</sup> / 20 ... 12 AWG
Fine-stranded conductor; with insulated ferrule	0.25 ... 1.5 mm <sup>2</sup> / 20 ... 16 AWG
Fine-stranded conductor; with uninsulated ferrule	0.25 ... 2.5 mm <sup>2</sup> / 20 ... 14 AWG
Fine-stranded conductor; with ferrule; push-in termination	1.5 mm <sup>2</sup> / 16 AWG
Strip length	9 mm / 0.35 inches
Pole number	2
Conductor entry direction to mating direction	0°
Strip length (outer insulation)	35 mm

## Physical data

Pin spacing	10 mm / 0.394 inches
Width	24.6 mm / 0.969 inches
Height	15.9 mm / 0.626 inches
Depth	71 mm / 2.795 inches

## Mechanical Data

Application	General mains applications
Coding	A
Variable coding	No
Marking	L N
Potential marking	L N
Mating force of a plug-in connection	approx. 20 ... 70 N (depending on pole number)
Retention force of a plug-in connection	Locked: > 80 N
Unmating force of a plug-in connection	Unlocked: approx. 20 ... 70 N (depending on pole number)

Subject to changes. Please also observe the further product documentation!



Number of mating cycles	200, without resistive load
Protection type	IP20; When mated and secured with a strain relief housing: IP2xC (These compact connectors are not designed for use in open, easily accessible areas!)

## Plug-in connection

Contact type (pluggable connector)	Female connector/socket
Connector (connection type)	for conductor
Mismating protection	Yes
Note on mismating protection	All <i>WINSTA</i> <sup>®</sup> components are 100% protected against mismating when: a.) plugging different numbers of poles b.) plugging while rotated 180 c.) plugging while laterally staggered d.) plugging one pole
Locking lever	Can be retrofitted
Locking of plug-in connection	locking lever
Note on locking system	All connectors for mounted installations (snap-in versions for lighting fixtures or devices, all types of PCB and distribution connectors) are factory-equipped with locking levers to ensure plugs and sockets are securely locked. Additional locking levers are only required for flying leads (plug/socket).
Strain relief	strain relief housing

## Material Data

Note (material data)	Information on material specifications can be found here
Color	black
Cover color	gray
Material group	I
Insulation material	Polyamide (PA66)
Flammability class per UL94	V0
Clamping spring material	Chrome-nickel spring steel (CrNi)
Contact material	Copper or copper alloy; surface-treated
Contact plating	Tin
Fire load	0.393 MJ
Weight	13 g

Subject to changes. Please also observe the further product documentation!

WAGO GmbH & Co. KG  
Hansastr. 27  
32423 Minden  
Phone: +49571 887-0 | Fax: +49571 887-169  
Email: [info.de@wago.com](mailto:info.de@wago.com) | Web: [www.wago.com](http://www.wago.com)

Do you have any questions about our products?  
We are always happy to take your call at +49 (571) 887-44222.

## Environmental requirements

Processing temperature	-5 ... +40 °C
Continuous operating temperature	-35 ... +85 °C
Note on continuous operating temperature	Insulating parts for temperatures ≤ 105 °C

## Commercial data



eCl@ss 10.0	27-44-06-05
eCl@ss 9.0	27-44-06-05
ETIM 8.0	EC002560
ETIM 7.0	EC002560
PU (SPU)	25 pcs
Packaging type	box
Country of origin	DE
GTIN	4050821117919
Customs tariff number	85366990990

## Environmental Product Compliance

RoHS Compliance Status	Compliant, No Exemption
------------------------	-------------------------

## Approvals / Certificates

### General approvals

Logo	Approval	Additional Approval Text	Certificate name
	CCA DEKRA Certification B.V.	EN 61535	71- 123228
	CCA DEKRA Certification B.V.	IEC 61535	NL -84761
	cURus Underwriters Laboratories Inc.	UL 1977	E45171

## Declarations of conformity and manufacturer's declarations



Logo	Approval	Additional Approval Text	Certificate name
	EU-Declaration of Conformity	-	-

Subject to changes. Please also observe the further product documentation!











WAGO GmbH &amp; Co. KG

## Approvals for marine applications

Logo	Approval	Additional Approval Text	Certificate name
	<b>ABS</b> American Bureau of Shipping	-	19- HG1868589- PDA
	<b>DNV GL</b> Det Norske Veritas, Germanischer Lloyd	-	TAE00001Z6
	<b>LR</b> Lloyds Register	IEC 61984	LR22429487TA

## Counterpart

	<b>Item no.770-112/041-000</b> Plug; with strain relief housing; 2-pole; Cod. A; 4,00 mm <sup>2</sup> ; black	<a href="http://www.wago.com/770-112/041-000">www.wago.com/770-112/041-000</a>
	<b>Item no.770-1606</b> T-distribution connector; 2-pole; Cod. A; 1 input; 2 outputs; 2 locking levers; black	<a href="http://www.wago.com/770-1606">www.wago.com/770-1606</a>
	<b>Item no.770-1615</b> T-distribution connector; 2-pole; Cod. A; 1 input; 2 outputs; 3 locking levers; for flying leads; black	<a href="http://www.wago.com/770-1615">www.wago.com/770-1615</a>
	<b>Item no.770-1634</b> h-distribution connector; 2-pole; Cod. A; 1 input; 2 outputs; outputs on one side; 2 locking levers; black	<a href="http://www.wago.com/770-1634">www.wago.com/770-1634</a>
	<b>Item no.770-1636</b> h-distribution connector; 2-pole; Cod. A; 1 input; 2 outputs; outputs on one side; 3 locking levers; for flying leads; black	<a href="http://www.wago.com/770-1636">www.wago.com/770-1636</a>
	<b>Item no.770-212</b> Plug; 2-pole; Cod. A; 4,00 mm <sup>2</sup> ; black	<a href="http://www.wago.com/770-212">www.wago.com/770-212</a>
	<b>Item no.771-8992/206-101</b> pre-assembled connecting cable; Eca; Plug/open-ended; 2-pole; Cod. A; H05VV-F 2 x 1.5 mm <sup>2</sup> ; 1 m; 1,50 mm <sup>2</sup> ; black	<a href="http://www.wago.com/771-8992/206-101">www.wago.com/771-8992/206-101</a>
	<b>Item no.771-8992/006-101</b>	<a href="http://www.wago.com/771-8992">www.wago.com/771-8992</a>

Subject to changes. Please also observe the further product documentation!

WAGO GmbH & Co. KG  
 Hansastr. 27  
 32423 Minden  
 Phone: +49571 887-0 | Fax: +49571 887-169  
 Email: [info.de@wago.com](mailto:info.de@wago.com) | Web: [www.wago.com](http://www.wago.com)

Do you have any questions about our products?  
 We are always happy to take your call at +49 (571) 887-44222.

pre-assembled interconnecting cable; Eca; Socket/plug; 2-pole; Cod. A; H05VV-F 2 x 1.5 mm<sup>2</sup>; 1 m; /006-101  
1,50 mm<sup>2</sup>; black

## Required accessories

### Locking levers

#### Locking system



**Item no.: 770-121**  
Locking lever; for flying leads; for manual operation; white

[www.wago.com/770-121](http://www.wago.com/770-121)



**Item no.: 770-131**  
Locking lever; for flying leads; for tool operation; white

[www.wago.com/770-131](http://www.wago.com/770-131)



**Item no.: 770-101**  
Locking lever; for flying leads; for manual operation; black

[www.wago.com/770-101](http://www.wago.com/770-101)



**Item no.: 770-111**  
Locking lever; for flying leads; for tool operation; black

[www.wago.com/770-111](http://www.wago.com/770-111)

## Optional accessories

### Cover

#### Cover



**Item no.: 770-201**  
Lockout cap; 12-pole, separable; for sockets; Plastic; black

[www.wago.com/770-201](http://www.wago.com/770-201)



**Item no.: 770-221**  
Lockout cap; 12-pole, separable; for sockets; Plastic; white

[www.wago.com/770-221](http://www.wago.com/770-221)



**Item no.: 897-2003**  
Protective cap; Type2; for sockets and plugs; PVC; red

[www.wago.com/897-2003](http://www.wago.com/897-2003)

### Tool

#### Operating tool



**Item no.: 210-719**  
Operating tool; Blade: 2.5 x 0.4 mm; with a partially insulated shaft

[www.wago.com/210-719](http://www.wago.com/210-719)



**Item no.: 770-382**  
Operating tool; 2-way; green

[www.wago.com/770-382](http://www.wago.com/770-382)

Subject to changes. Please also observe the further product documentation!



## Downloads

### Documentation

#### Bid Text

770-102/041-000 X81 - Datei	2019 Feb 19	xml 3.1 kB	Download
--------------------------------	-------------	---------------	----------

770-102/041-000 doc - Datei	2015 Jun 8	doc 24.1 kB	Download
--------------------------------	------------	----------------	----------

## CAD/CAE-Data

### CAD data

2D/3D Models 770-102/041-000	URL	Download
------------------------------	-----	----------

### CAE data

WSCAD Universe 770-102/041-000	URL	Download
--------------------------------	-----	----------

ZUKEN Portal 770-102/041-000	URL	Download
------------------------------	-----	----------

WSCAD Universe 770-102/041-000	URL	Download
--------------------------------	-----	----------

## Environmental Product Compliance

### Compliance Search

Environmental Product Compliance 770-102/041-000 Socket; with strain relief housing; 2-pole; Cod. A; 4,00 mm <sup>2</sup> ; black	URL	Download
--	-----	----------

## Installation Notes

### Conductor termination

Subject to changes. Please also observe the further product documentation!

WAGO GmbH & Co. KG  
 Hansastr. 27  
 32423 Minden  
 Phone: +49571 887-0 | Fax: +49571 887-169  
 Email: [info.de@wago.com](mailto:info.de@wago.com) | Web: [www.wago.com](http://www.wago.com)

Do you have any questions about our products?  
 We are always happy to take your call at +49 (571) 887-44222.



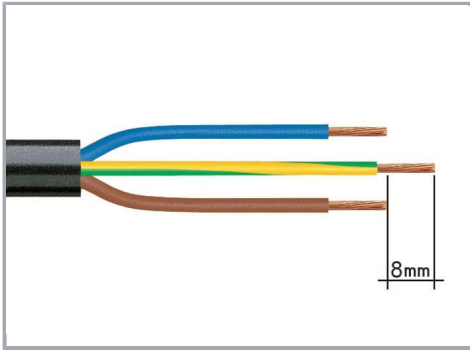

1. Strip length, outer insulation = 35 mm (2-pole), 55 mm (3- to 5-pole)
2. Strip length = 9 mm
3. Extended ground conductor = 8 mm

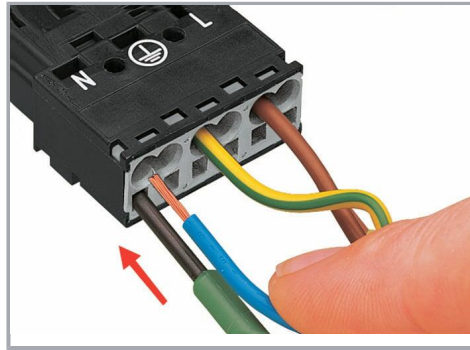

To terminate fine-stranded conductors, open the clamping unit via screwdriver (2.5 mm blade width) and insert a stripped conductor until it hits the backstop.

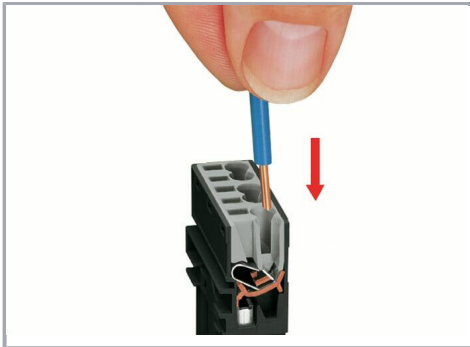

Insert the stripped solid conductor until it hits the backstop.

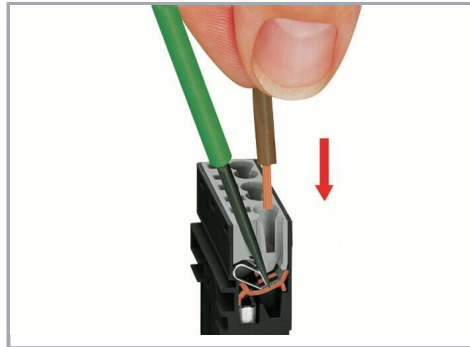

To terminate fine-stranded conductors, open the clamping unit via screwdriver (2.5 mm blade width) and insert a stripped conductor until it hits the backstop.

### Conductor removal

Subject to changes. Please also observe the further product documentation!

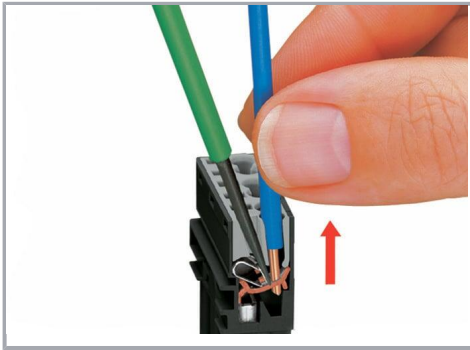

To remove the conductor, actuate the clamp via screwdriver (2.5 mm blade width) and pull out the conductor.

### Installation

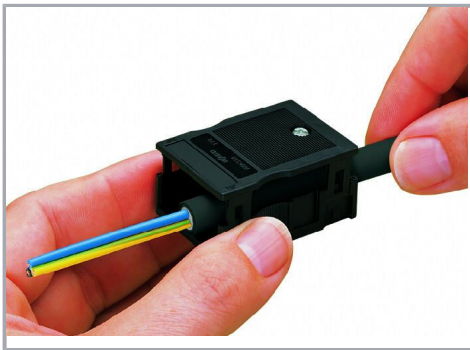

We recommend pulling the pre-latched strain relief housing over the cable prior to termination. However, the strain relief can be mounted at a later time as well.

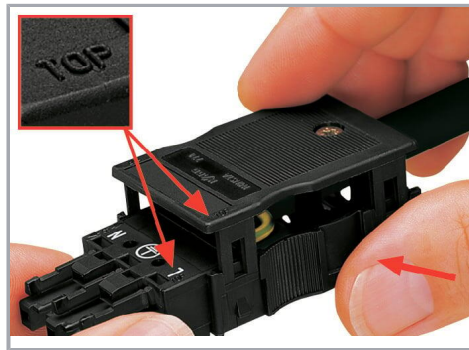

Latch the strain relief housing onto the plug /socket. Note the "TOP" inscription.

Subject to changes. Please also observe the further product documentation!

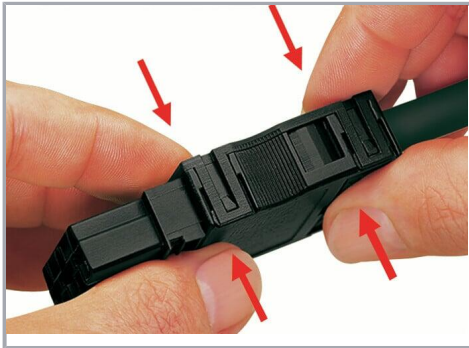

Prepare strain relief housing by snapping together upper and bottom part.



Tighten strain relief screw with screwdriver (2.5 mm blade width).

## Product family

### WINSTA® MIDI

[Show all products from the family](#)

Subject to changes. Please also observe the further product documentation!