

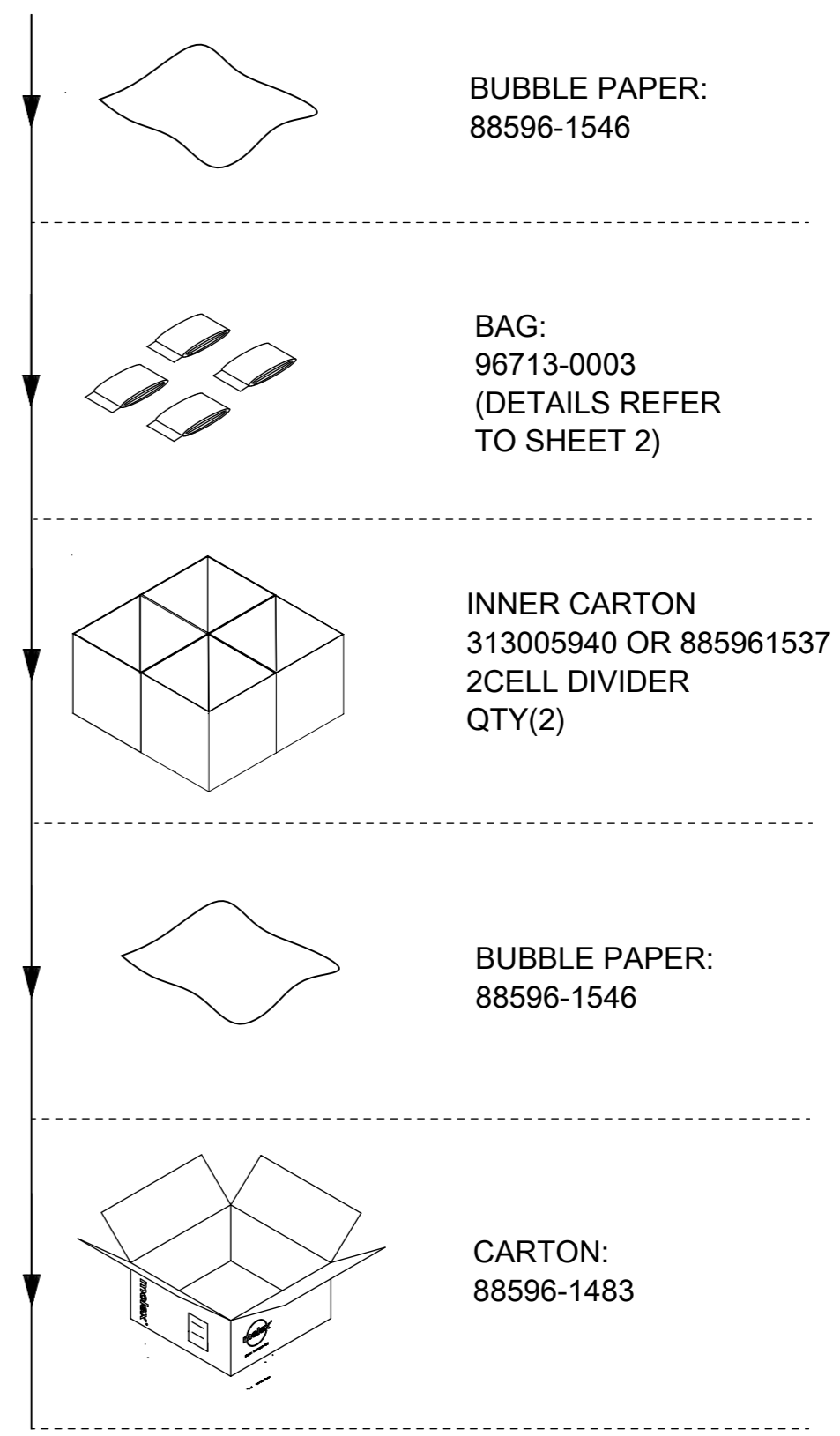





PART NUMBER	CKTS	QUANTITY PER BAG	BAGS PER CARTON	PARTS PER CARTON (SPQ)	MOISTURIZATION METHOD 	PANEL LOCK
215922-0201	2	3000	4	12000	NO MOISTURIZATION	WITHOUT
215922-0401	4	2600	4	10400		
215922-0601	6	2000	4	8000		
215922-0801	8	1700	4	6800		
215922-1001	10	1400	4	5600		
215922-1201	12	1000	4	4000		
215922-1401	14	800	4	3200		
215922-1601	16	800	4	3200		
215922-1801	18	600	4	2400		
215922-2001	20	600	4	2400		
215922-2201	22	600	4	2400		
215922-2401	24	450	4	1800		
215922-0200	2	2000	4	8000	SEE SHEET 2	WITH
215922-0400	4	1800	4	7200		
215922-0600	6	1600	4	6400		
215922-0800	8	1100	4	4400		
215922-1000	10	1000	4	4000		
215922-1200	12	900	4	3600		
215922-1400	14	800	4	3200		
215922-1600	16	700	4	2800		
215922-1800	18	600	4	2400		
215922-2000	20	600	4	2400		
215922-2200	22	400	4	1600		
215922-2400	24	350	4	1400		

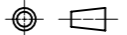

TBD: NO PRODUCTION, TO BE ADDED AFTER BEING PRODUCED.

- NOTES:
-  MOISTURIZATION METHOD DESCRIPTIONS REFER TO SHEET 2.
  - STANDARD PACKAGE QUANTITY (SPQ) SEE ABOVE CHART.
  - PACKAGE WAY FOLLOW RIGHT ILLUSTRATION.
  - ALL PACKAGE MATERIAL AND PRODUCT COMPLIANT TO RoHS DIRECTIVE 2011/65/EU AND ELV DIRECTIVE 2000/53/EC.

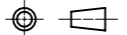
FUNCTIONAL SYMBOLS	THIS DRAWING CONTAINS INFORMATION THAT IS PROPRIETARY TO MOLEX ELECTRONIC TECHNOLOGIES, LLC AND SHOULD NOT BE USED WITHOUT WRITTEN PERMISSION		CURRENT REV DESC:					
	DIMENSION UNITS	SCALE						
 = 0	mm	1:1	GENERAL TOLERANCES (UNLESS SPECIFIED)		PACKING SPEC FOR MICRO-FIT PLUS WTW HSG			
 = 0	ANGULAR TOL ± °							
 = 0								4 PLACES ±
DIVISIONAL SYMBOLS								3 PLACES ± 0.1
	2 PLACES ± 0.3	DRWN: GLLI	2022/10/31					
	1 PLACE ± 0.5	CHK'D: XQZHANG	2022/10/31					
	0 PLACES ±	APPR: XQZHANG	2022/10/31					
DRAFT WHERE APPLICABLE MUST REMAIN WITHIN DIMENSIONS		THIRD ANGLE PROJECTION	DRAWING	SERIES	DOCUMENT NUMBER	DOC TYPE	DOC PART	REVISION
			A3-SIZE	215922	2159220000-PK	PSD	000	B
					MATERIAL NUMBER	CUSTOMER	SHEET NUMBER	
							1 OF 2	

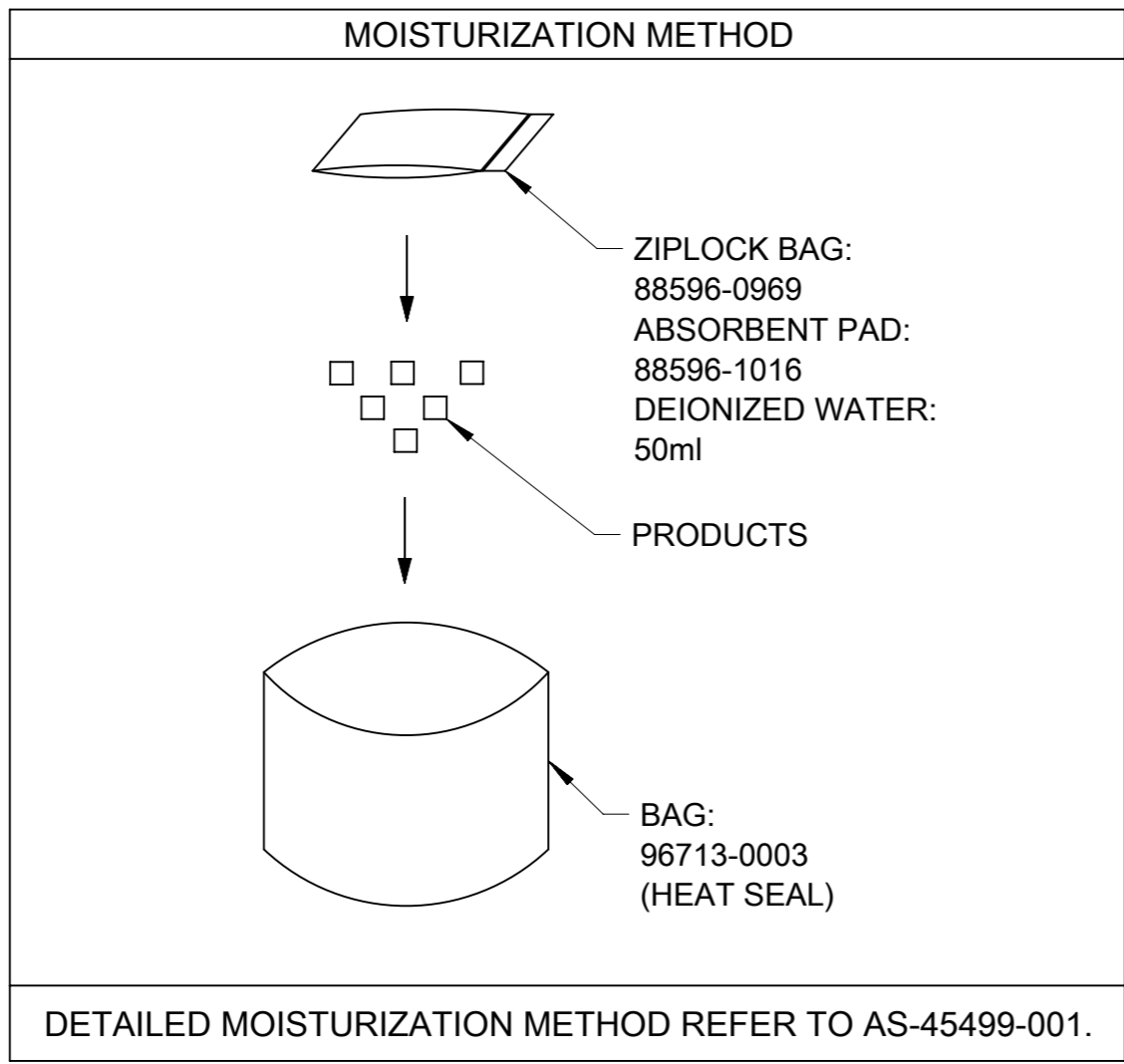

<b>FUNCTIONAL SYMBOLS</b>	THIS DRAWING CONTAINS INFORMATION THAT IS PROPRIETARY TO MOLEX ELECTRONIC TECHNOLOGIES, LLC AND SHOULD NOT BE USED WITHOUT WRITTEN PERMISSION		
$\nabla_A = 0$	DIMENSION UNITS	SCALE	<p style="margin: 0;"><b>molex</b></p> <p style="margin: 0; font-size: 8px;">PACKING SPEC FOR MICRO-FIT PLUS WTW HSG</p> <p style="margin: 0; font-size: 8px;">PRODUCT CUSTOMER DRAWING</p>
$\nabla_F = 0$	mm	1:1	
$\nabla_P = 0$	GENERAL TOLERANCES (UNLESS SPECIFIED)		
	ANGULAR TOL	± °	
<b>DIVISIONAL SYMBOLS</b>			EC NO: 725570 DRWN: GLLI 2022/08/29 CHK'D: XQZHANG 2022/10/31 APPR: XQZHANG 2022/10/31
	4 PLACES	±	INITIAL REVISION:
	3 PLACES	± 0.1	DRWN: GLLI 2021/10/28
	2 PLACES	± 0.3	APPR: XQZHANG 2021/11/15
	1 PLACE	± 0.5	
	0 PLACES	±	
DRAFT WHERE APPLICABLE MUST REMAIN WITHIN DIMENSIONS		THIRD ANGLE PROJECTION	DRAWING
			SERIES
			MATERIAL NUMBER
		A3-SIZE	CUSTOMER
		215922	SHEET NUMBER
			2 OF 2

# FREE HANGING PLUG PARTS

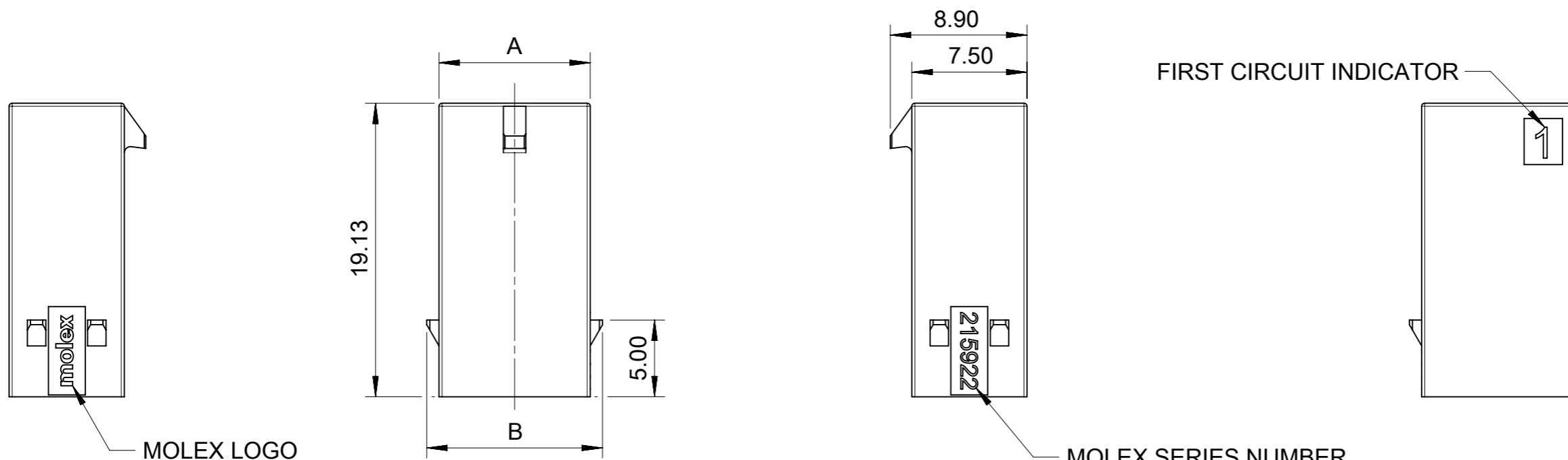

MOLEX LOGO

MOLEX SERIES NUMBER

FIRST CIRCUIT INDICATOR

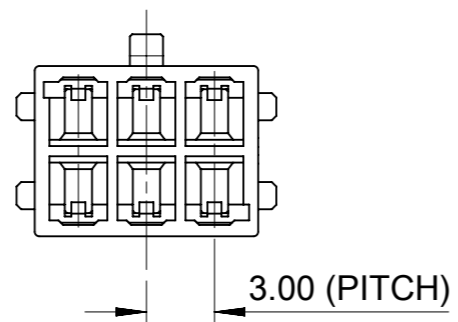

3.00 (PITCH)

PART No	DIM'A'	DIM'B'	CKT SIZE
215922-0201	3.85	5.45	2
215922-0401	6.85	8.45	4
215922-0601	9.85	11.45	6
215922-0801	12.85	14.45	8
215922-1001	15.85	17.45	10
215922-1201	18.85	20.45	12
215922-1401	21.85	23.45	14
215922-1601	24.85	26.45	16
215922-1801	27.85	29.45	18
215922-2001	30.85	32.45	20
215922-2201	33.85	35.45	22
215922-2401	36.85	38.45	24

**NOTES:**

1. MATERIAL: PA66, 94V-0, BLACK.
2. PRODUCT SPECIFICATION: 2159530000-PS.
3. PACKAGE SPECIFICATION: 2159220000-PK.
4. TO USE WITH TERMINAL OF 2015953-\*\*\*\*.
5. TO USE WITH TPA OF 206462-\*\*\*\*.
6. TO MATE WITH RECEPTACLE OF 206461-\*\*\*\*.
7. PARTS CONFORM TO CLASS 'B' REQUIREMENTS OF COSMETIC SPECIFICATION PS-45499-002.

FUNCTIONAL SYMBOLS	THIS DRAWING CONTAINS INFORMATION THAT IS PROPRIETARY TO MOLEX ELECTRONIC TECHNOLOGIES, LLC AND SHOULD NOT BE USED WITHOUT WRITTEN PERMISSION		CURRENT REV DESC:		<b>molex</b>				
	DIMENSION UNITS	SCALE							PLUG HOUSING OF MICRO-FIT PLUS WTW DR POWER CONNECTOR
$\nabla_A = 0$	mm	1:1	EC NO: 712744 DRWN: GLLI 2022/07/01 CHK'D: XQZHANG 2022/07/05 APPR: XQZHANG 2022/07/05		PRODUCT CUSTOMER DRAWING				
$\nabla_E = 0$	GENERAL TOLERANCES (UNLESS SPECIFIED)				DOCUMENT NUMBER		DOC TYPE	DOC PART	REVISION
$\nabla_F = 0$	ANGULAR TOL ± °				2159220000-SD		PSD	000	A1
DIVISIONAL SYMBOLS	4 PLACES ±		INITIAL REVISION:						
	3 PLACES ±		DRWN: GLLI 2021/01/29						
	2 PLACES ± 0.2		APPR: XQZHANG 2021/11/15						
	1 PLACE ± 0.3								
	0 PLACES ±								
	DRAFT WHERE APPLICABLE MUST REMAIN WITHIN DIMENSIONS		THIRD ANGLE PROJECTION	DRAWING	SERIES	MATERIAL NUMBER	CUSTOMER	SHEET NUMBER	
				A3-SIZE	215922		GENERAL MARKET	1 OF 6	

# FREE HANGING PLUG PARTS

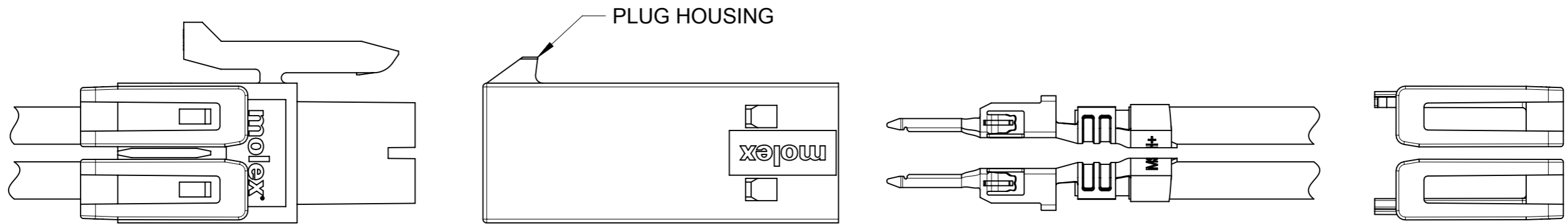
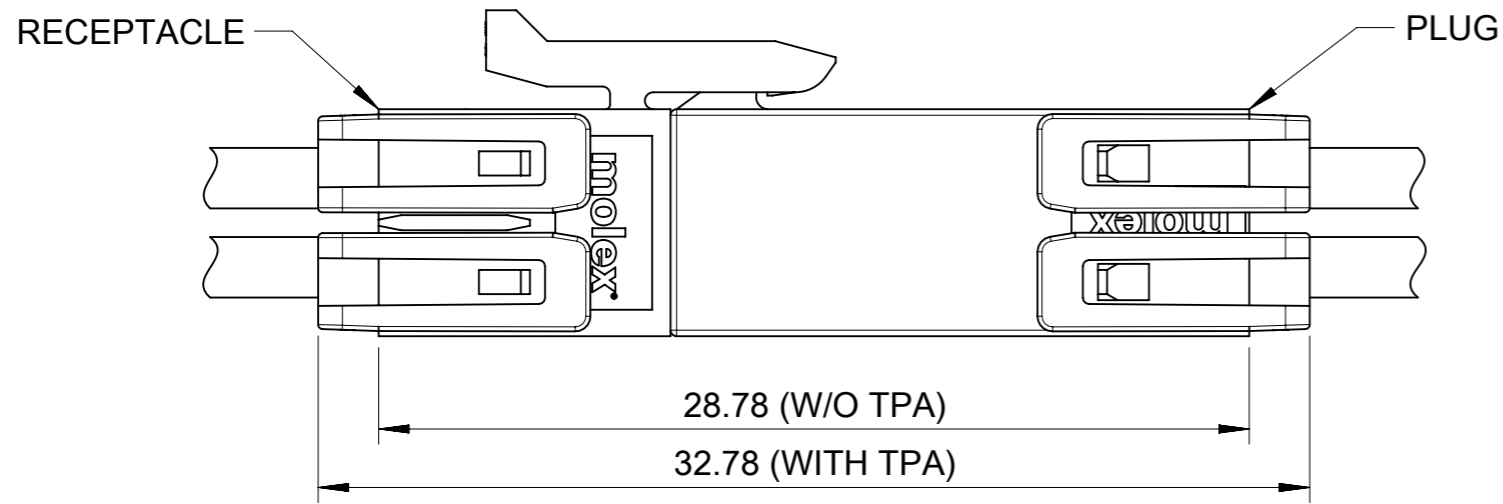

FUNCTIONAL SYMBOLS	THIS DRAWING CONTAINS INFORMATION THAT IS PROPRIETARY TO MOLEX ELECTRONIC TECHNOLOGIES, LLC AND SHOULD NOT BE USED WITHOUT WRITTEN PERMISSION		
	△/A = 0	mm	SCALE 1:1
DIVISIONAL SYMBOLS	CURRENT REV DESC:		
	△/E = 0	GENERAL TOLERANCES (UNLESS SPECIFIED)	
DIVISIONAL SYMBOLS	△/V = 0	ANGULAR TOL ± °	
		4 PLACES	±
		3 PLACES	±
		2 PLACES	± 0.2
		1 PLACE	± 0.3
	0 PLACES	±	
DRAFT WHERE APPLICABLE MUST REMAIN WITHIN DIMENSIONS		THIRD ANGLE PROJECTION	DRAWING A3-SIZE
		SERIES 215922	
		MATERIAL NUMBER	CUSTOMER
		2159220000-SD	GENERAL MARKET
		DOCUMENT NUMBER	DOC TYPE DOC PART REVISION
		2159220000-SD	PSD 000 A1
		EC NO: 712744	
		DRWN: GLLI	2022/07/01
		CHK'D: XQZHANG	2022/07/05
		APPR: XQZHANG	2022/07/05
		INITIAL REVISION:	
		DRWN: GLLI	2021/01/29
		APPR: XQZHANG	2021/11/15
		SHEET NUMBER	2 OF 6

# FREE HANGING PLUG PARTS

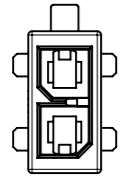

2 CKT

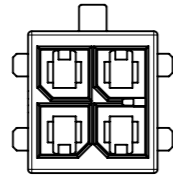

4 CKT

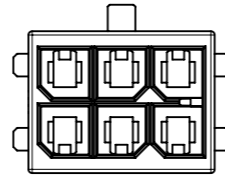

6 CKT

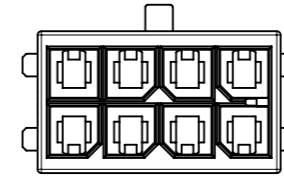

8 CKT

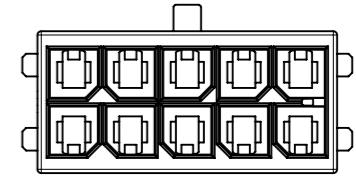

10 CKT

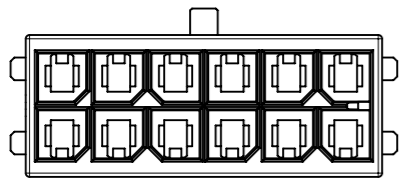

12 CKT

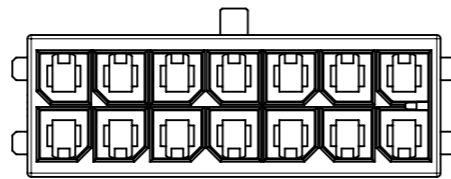

14 CKT

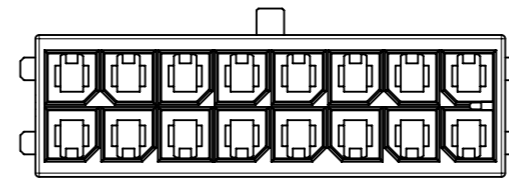

16 CKT

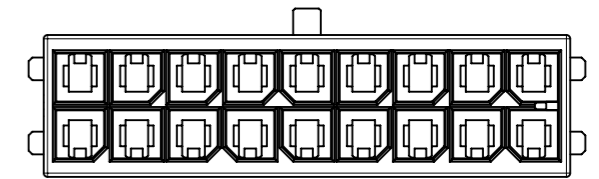

18 CKT

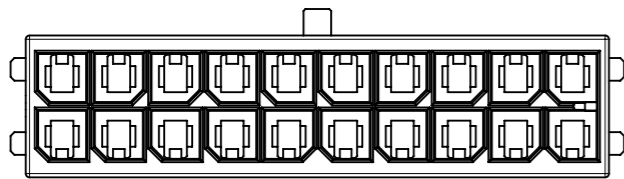

20 CKT

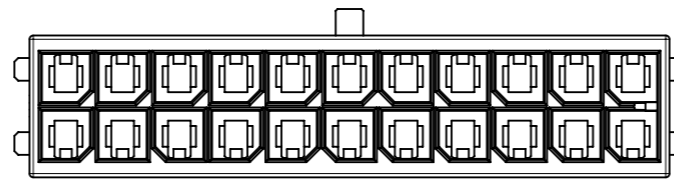

22 CKT

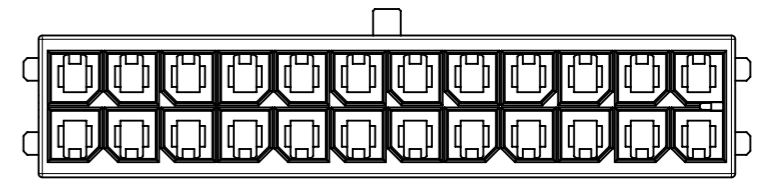

24 CKT

FUNCTIONAL SYMBOLS	THIS DRAWING CONTAINS INFORMATION THAT IS PROPRIETARY TO MOLEX ELECTRONIC TECHNOLOGIES, LLC AND SHOULD NOT BE USED WITHOUT WRITTEN PERMISSION		CURRENT REV DESC:					
	$\nabla/A = 0$ $\nabla/E = 0$ $\nabla/P = 0$	DIMENSION UNITS <b>mm</b>						
DIVISIONAL SYMBOLS	4 PLACES	±	EC NO: 712744		PLUG HOUSING OF MICRO-FIT PLUS WTW DR POWER CONNECTOR			
	3 PLACES	±	DRWN: GLLI		PRODUCT CUSTOMER DRAWING			
	2 PLACES	± 0.2	CHK'D: XQZHANG		DOCUMENT NUMBER			
	1 PLACE	± 0.3	APPR: XQZHANG		2159220000-SD			
	0 PLACES	±	INITIAL REVISION:		DOC TYPE DOC PART REVISION			
DRAFT WHERE APPLICABLE MUST REMAIN WITHIN DIMENSIONS		THIRD ANGLE PROJECTION		DRAWING	SERIES	MATERIAL NUMBER	CUSTOMER	SHEET NUMBER
				A3-SIZE	215922		GENERAL MARKET	3 OF 6

# PANEL MOUNT PLUG PARTS

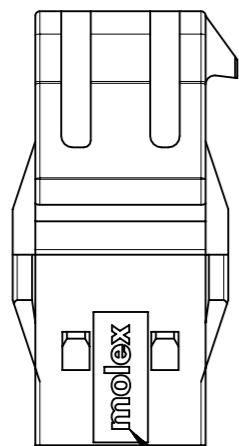

MOLEX LOGO

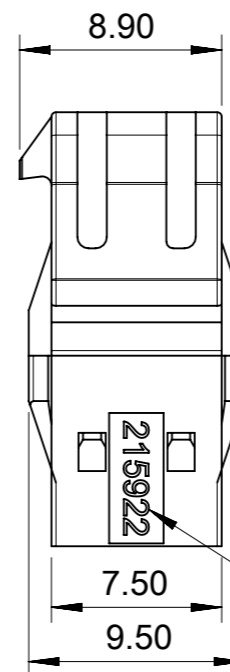
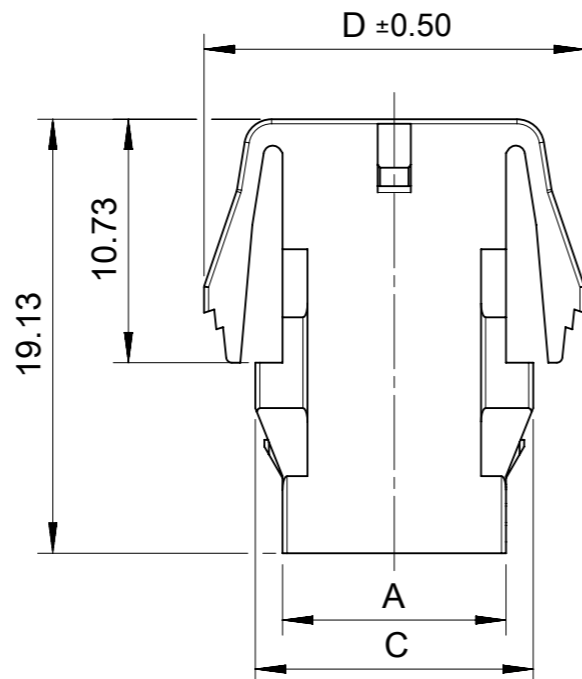

FIRST CIRCUIT INDICATOR

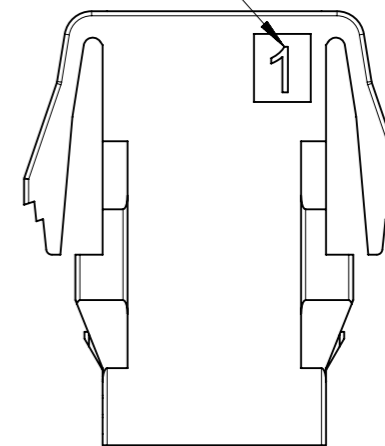

MOLEX SERIES NUMBER

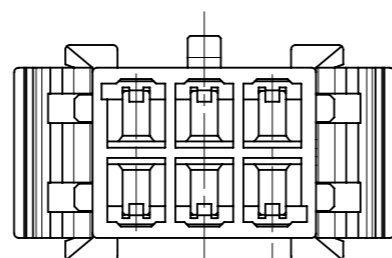

3.00 (PITCH)

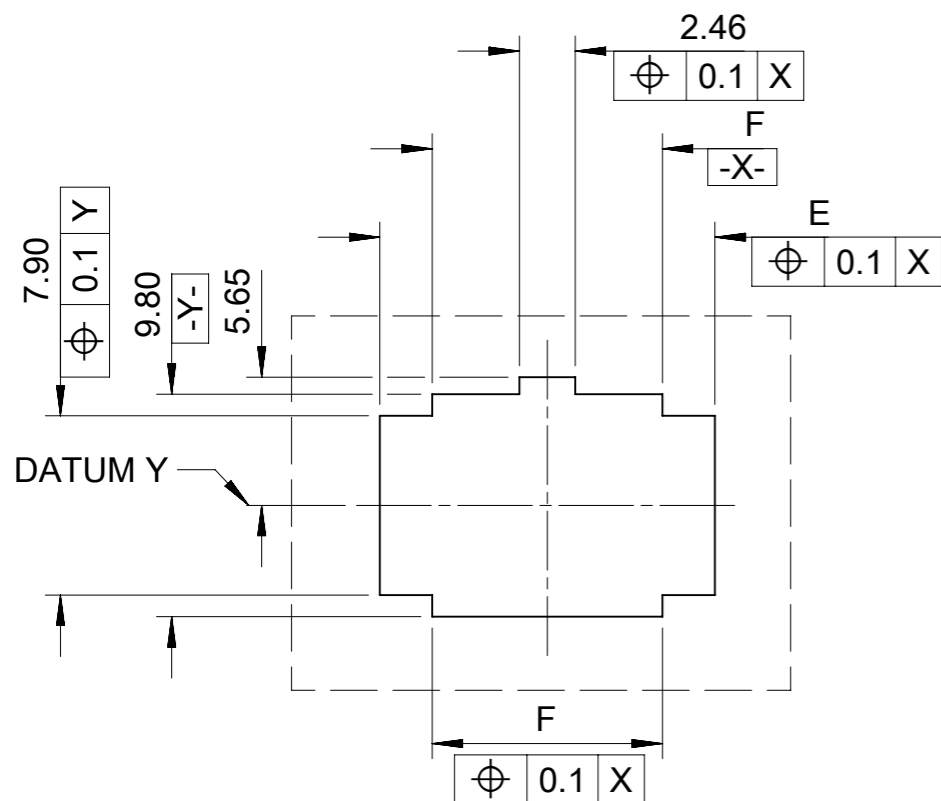

RECOMMENDED PANEL CUT OUT  
(TOLERANCE +/-0.05 THICKNESS=1.2~2.2MM)

PART No	DIM 'A'	DIM 'C'	DIM 'D'	DIM 'E'	DIM 'F'	CKT SIZE
215922-0200	3.85	6.25	10.77	8.77	4.15	2
215922-0400	6.85	9.25	13.77	11.77	7.15	4
215922-0600	9.85	12.25	16.77	14.77	10.15	6
215922-0800	12.85	15.25	19.77	17.77	13.15	8
215922-1000	15.85	18.25	22.77	20.77	16.15	10
215922-1200	18.85	21.25	25.77	23.77	19.15	12
215922-1400	21.85	24.25	28.77	26.77	22.15	14
215922-1600	24.85	27.25	31.77	29.77	25.15	16
215922-1800	27.85	30.25	34.77	32.77	28.15	18
215922-2000	30.85	33.25	37.77	35.77	31.15	20
215922-2200	33.85	36.25	40.77	38.77	34.15	22
215922-2400	36.85	39.25	43.77	41.77	37.15	24

FUNCTIONAL SYMBOLS	THIS DRAWING CONTAINS INFORMATION THAT IS PROPRIETARY TO MOLEX ELECTRONIC TECHNOLOGIES, LLC AND SHOULD NOT BE USED WITHOUT WRITTEN PERMISSION		CURRENT REV DESC:		<b>molex</b>			
	GENERAL TOLERANCES (UNLESS SPECIFIED)	SCALE						
$\nabla_A = 0$ $\nabla_E = 0$ $\nabla_F = 0$	mm	1:1	EC NO: 712744 DRWN: GLLI 2022/07/01 CHK'D: XQZHANG 2022/07/05 APPR: XQZHANG 2022/07/05		PRODUCT CUSTOMER DRAWING			
DIVISIONAL SYMBOLS	ANGULAR TOL ± °				INITIAL REVISION:		DOCUMENT NUMBER	DOC TYPE
4 PLACES ±	±		DRWN: GLLI 2021/01/29		2159220000-SD	PSD	000	A1
3 PLACES ±	±		APPR: XQZHANG 2021/11/15		SHEET NUMBER			
2 PLACES ±	± 0.2		THIRD ANGLE PROJECTION		MATERIAL NUMBER		CUSTOMER	
1 PLACE ±	± 0.3		DRAWING		SERIES		GENERAL MARKET	
0 PLACES ±	±		A3-SIZE		215922		4 OF 6	
DRAFT WHERE APPLICABLE MUST REMAIN WITHIN DIMENSIONS								

# PANEL MOUNT PLUG PARTS

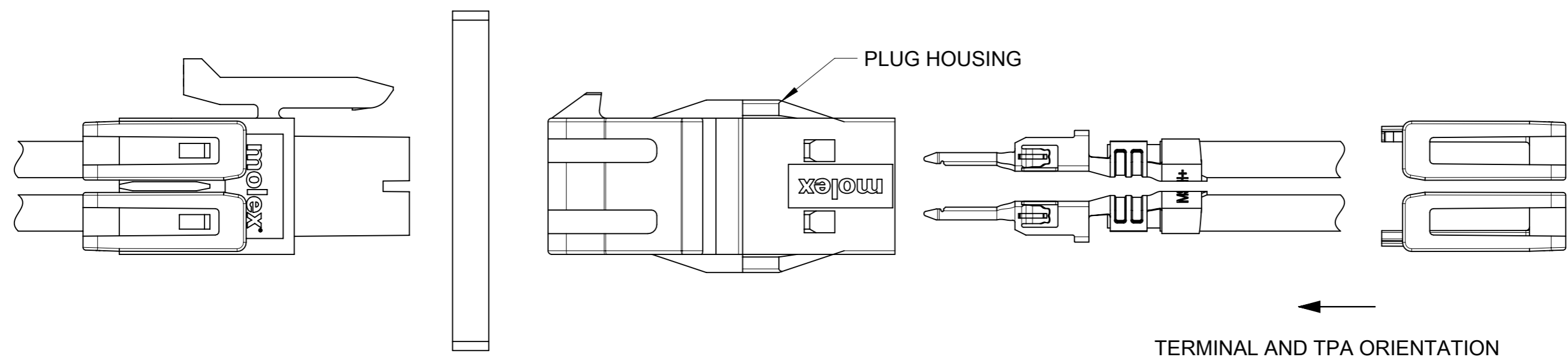
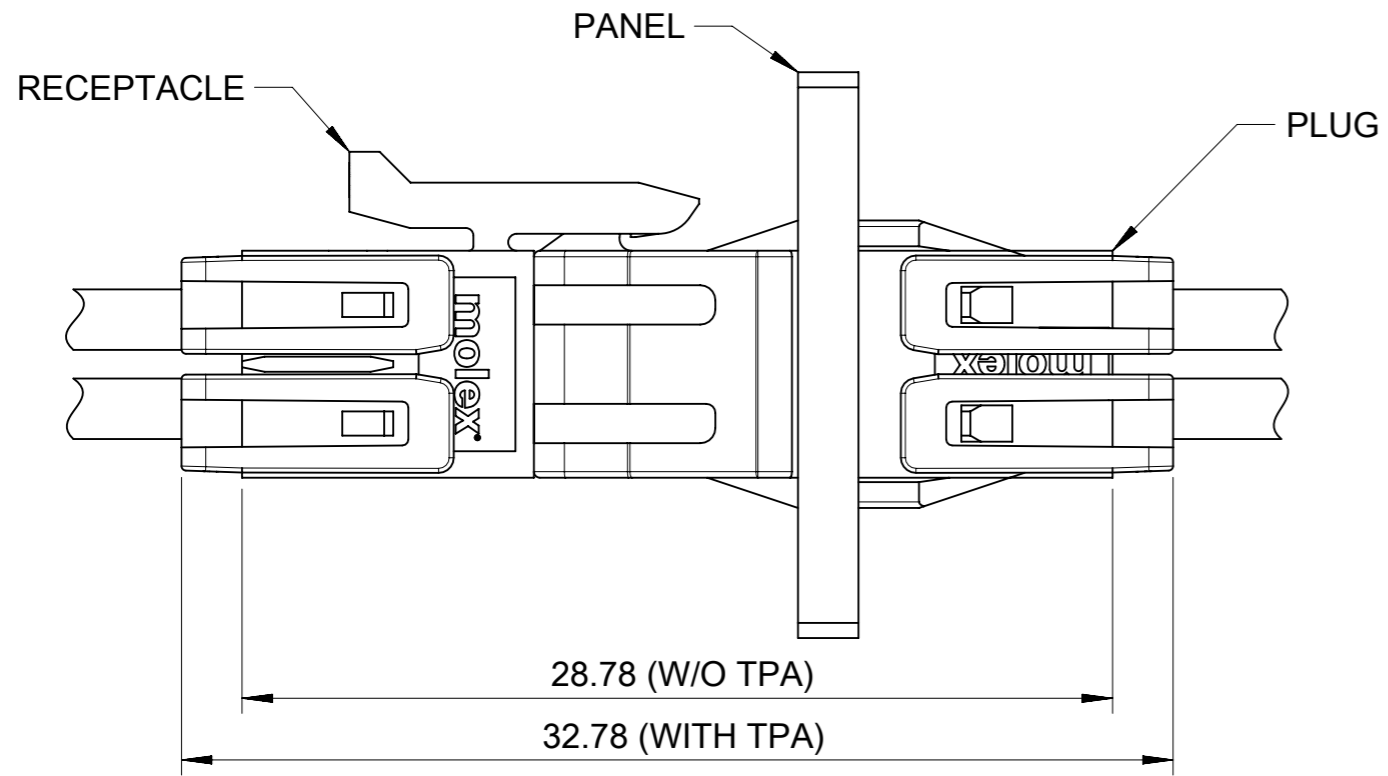

FUNCTIONAL SYMBOLS	THIS DRAWING CONTAINS INFORMATION THAT IS PROPRIETARY TO MOLEX ELECTRONIC TECHNOLOGIES, LLC AND SHOULD NOT BE USED WITHOUT WRITTEN PERMISSION		
	△/A = 0	mm	SCALE 1:1
DIVISIONAL SYMBOLS	CURRENT REV DESC:		
	△/E = 0	GENERAL TOLERANCES (UNLESS SPECIFIED)	
DIVISIONAL SYMBOLS	△/F = 0	ANGULAR TOL ± °	
	4 PLACES	±	
	3 PLACES	±	
	2 PLACES	± 0.2	
	1 PLACE	± 0.3	
0 PLACES	±		
DRAFT WHERE APPLICABLE MUST REMAIN WITHIN DIMENSIONS		THIRD ANGLE PROJECTION	DRAWING A3-SIZE
		SERIES 215922	MATERIAL NUMBER
		CUSTOMER GENERAL MARKET	SHEET NUMBER 5 OF 6

**molex**

PLUG HOUSING OF MICRO-FIT PLUS WTW DR POWER CONNECTOR

PRODUCT CUSTOMER DRAWING

DOCUMENT NUMBER: 2159220000-SD

DOC TYPE: PSD

DOC PART: 000

REVISION: A1

# PANEL MOUNT PLUG PARTS

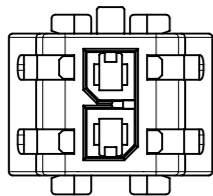

2 CKT

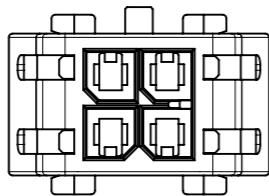

4 CKT

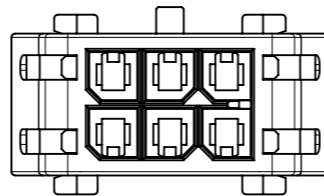

6 CKT

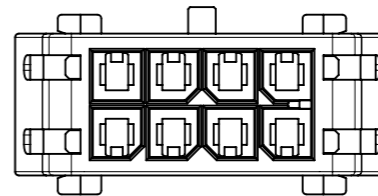

8 CKT

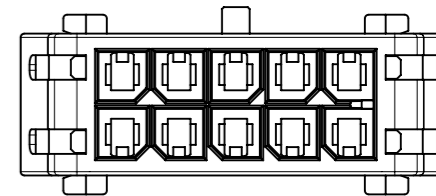

10 CKT

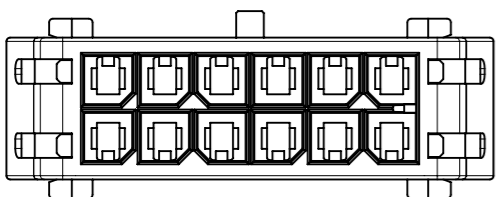

12 CKT

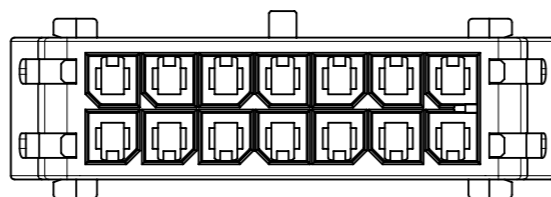

14 CKT

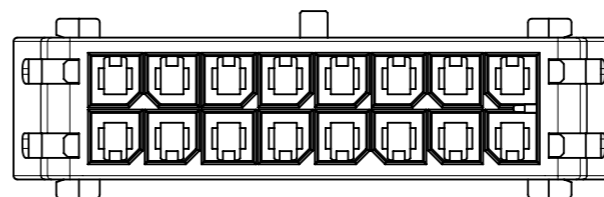

16 CKT

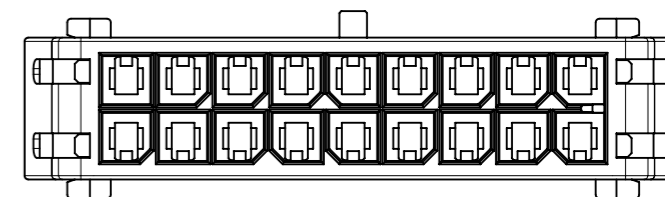

18 CKT

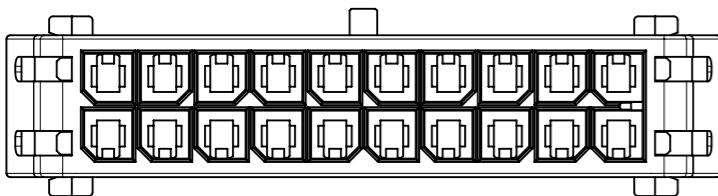

20 CKT

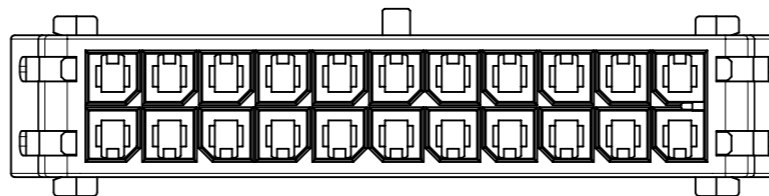

22 CKT

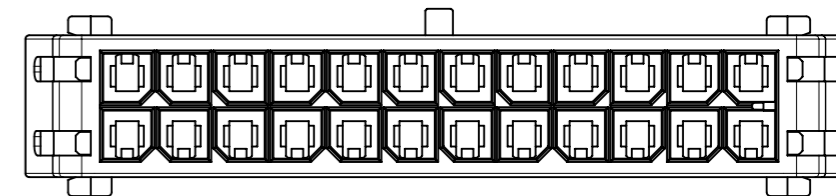

24 CKT

FUNCTIONAL SYMBOLS	THIS DRAWING CONTAINS INFORMATION THAT IS PROPRIETARY TO MOLEX ELECTRONIC TECHNOLOGIES, LLC AND SHOULD NOT BE USED WITHOUT WRITTEN PERMISSION		CURRENT REV DESC:		<b>molex</b>						
	mm	1:1									
DIVISIONAL SYMBOLS	GENERAL TOLERANCES (UNLESS SPECIFIED)		EC NO: 712744 DRWN: GLLI CHK'D: XQZHANG APPR: XQZHANG INITIAL REVISION: DRWN: GLLI APPR: XQZHANG		PLUG HOUSING OF MICRO-FIT PLUS WTW DR POWER CONNECTOR						
	ANGULAR TOL ± °				PRODUCT CUSTOMER DRAWING						
	4 PLACES ±				2022/07/01		DOCUMENT NUMBER		DOC TYPE	DOC PART	REVISION
	3 PLACES ±				2022/07/05		2159220000-SD		PSD	000	A1
	2 PLACES ± 0.2				2022/07/05		2021/01/29		SHEET NUMBER		
1 PLACE ± 0.3		2021/11/15		DRAWING		SERIES	MATERIAL NUMBER	CUSTOMER			
0 PLACES ±				A3-SIZE		215922	GENERAL MARKET		6 OF 6		
DRAFT WHERE APPLICABLE MUST REMAIN WITHIN DIMENSIONS		THIRD ANGLE PROJECTION									