

MOSFET - Power, N-Channel, PowerTrench® Power Clip, Symmetric Dual 30 V NTTFD4D1N03P1E

Features

- Latest 30 V MOSFET Technology with Optimized Figure-of-Merit
- Less Junction Capacitance for High Switching Frequency Application
- Lower Q_{GD}/Q_{GS} for Shoot-Through Preventing
- Small Footprint (3.3mm x 3.3mm) for Compact Design
- These Devices are Pb-Free and are RoHS Compliant

Typical Applications

- DC-DC Converters
- System Voltage Rails

MAXIMUM RATINGS (T_J = 25°C unless otherwise noted)

Parameter		Symbol	Q1	Q2	Unit	
Drain-to-Source Voltage		V _{DSS}	30	30	V	
Gate-to-Source Voltage		V _{GS}	+16 -12	+16 -12	V	
Continuous Drain Current R _{θJC} (Note 3)	Steady State	T _C = 25°C	I _D	54	54	A
		T _C = 85°C		38	38	
Power Dissipation R _{θJC} (Note 3)		T _C = 25°C	P _D	20	20	W
Continuous Drain Current R _{θJA} (Notes 1, 3)	Steady State	T _A = 25°C	I _D	15	15	A
		T _A = 85°C		11	11	
Power Dissipation R _{θJA} (Notes 1, 3)		T _A = 25°C	P _D	1.7	1.7	W
Continuous Drain Current R _{θJA} (Notes 2, 3)	Steady State	T _A = 25°C	I _D	12	12	A
		T _A = 85°C		8	8	
Power Dissipation R _{θJA} (Notes 2, 3)		T _A = 25°C	P _D	1.0	1.0	W
Pulsed Drain Current	T _A = 25°C, t _p = 10 μs	I _{DM}	408	408	A	
Single Pulse Drain-to-Source Avalanche Energy Q1: I _L = 7 A _{pk} , L = 3 mH (Note 4) Q2: I _L = 7 A _{pk} , L = 3 mH (Note 4)		E _{AS}	74	74	mJ	
Operating Junction and Storage Temperature		T _J , T _{stg}	-55 to + 150		°C	
Lead Temperature for Soldering Purposes (1/8" from case for 10 s)		T _L	260		°C	

Stresses exceeding those listed in the Maximum Ratings table may damage the device. If any of these limits are exceeded, device functionality should not be assumed, damage may occur and reliability may be affected.

1. Surface-mounted on FR4 board using a 1 in² pad size, 2 oz. Cu pad.
2. Surface-mounted on FR4 board using minimum pad size, 2 oz. Cu pad.
3. The entire application environment impacts the thermal resistance values shown, they are not constants and are only valid for the particular conditions noted. Actual continuous current will be limited by thermal & electro-mechanical application board design. R_{θJC} is determined by the user's board design.
4. Q1 100% UIS tested at L = 3 mH, IAS = 7 A.
Q2 100% UIS tested at L = 3 mH, IAS = 7 A.
5. This device is Class 1B ESD HBM Rating.

FET	V _{(BR)DSS}	R _{DS(ON) MAX}	I _{D MAX}
Q1	30 V	4.3 mΩ @ 10 V	54 A
		5.4 mΩ @ 4.5 V	
Q2	30 V	3.5 mΩ @ 10 V	54 A
		4.5 mΩ @ 4.5 V	

ELECTRICAL CONNECTION

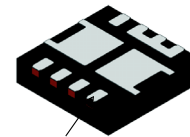
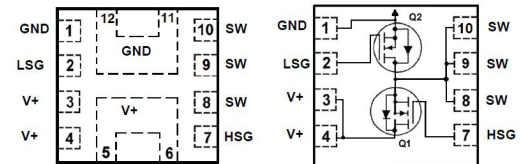

PIN1
WQFN12
3.3X3.3, 0.65P
CASE 510CJ

MARKING DIAGRAM

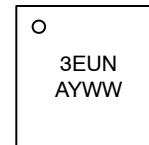

3EUN = Specific Device Code
A = Assembly Location
Y = Year
WW = Work Week

ORDERING INFORMATION

Device	Package	Shipping†
NTTFD4D1N03P1E	WQFN12 (Pb-Free)	3000 / Tape & Reel

†For information on tape and reel specifications, including part orientation and tape sizes, please refer to our Tape and Reel Packaging Specifications Brochure, BRD8011/D.

NTTFD4D1N03P1E

THERMAL RESISTANCE MAXIMUM RATINGS

Parameter	Symbol	Q1 Max	Q2 Max	Unit
Junction-to-Case – Steady State (Notes 1, 3)	$R_{\theta JC}$	6.0	6.0	°C/W
Junction-to-Ambient – Steady State (Notes 1, 3)	$R_{\theta JA}$	70	70	
Junction-to-Ambient – Steady State (Notes 2, 3)	$R_{\theta JA}$	120	120	

ELECTRICAL CHARACTERISTICS ($T_J = 25^\circ\text{C}$ unless otherwise specified)

Parameter	Symbol	Test Condition	FET	Min	Typ	Max	Unit
-----------	--------	----------------	-----	-----	-----	-----	------

OFF CHARACTERISTICS

Drain-to-Source Breakdown Voltage	$V_{(BR)DSS}$	$V_{GS} = 0\text{ V}, I_D = 1\text{ mA}$		Q1	30		V
		$V_{GS} = 0\text{ V}, I_D = 1\text{ mA}$		Q2	30		
Drain-to-Source Breakdown Voltage Temperature Coefficient	$V_{(BR)DSS}/T_J$	$I_D = 1\text{ mA}, \text{ ref to } 25^\circ\text{C}$		Q1		17	mV/°C
		$I_D = 1\text{ mA}, \text{ ref to } 25^\circ\text{C}$		Q2		17	
Zero Gate Voltage Drain Current	I_{DSS}	$V_{GS} = 0\text{ V}, V_{DS} = 24\text{ V}$	$T_J = 25^\circ\text{C}$	Q1		1.0	μA
				Q2		1.0	
Gate-to-Source Leakage Current	I_{GSS}	$V_{DS} = 0\text{ V}, V_{GS} = +16\text{ V} / -12\text{ V}$		Q1		± 100	nA
		$V_{DS} = 0\text{ V}, V_{GS} = +16\text{ V} / -12\text{ V}$		Q2		± 100	

ON CHARACTERISTICS (Note 6)

Gate Threshold Voltage	$V_{GS(TH)}$	$V_{GS} = V_{DS}, I_D = 270\text{ }\mu\text{A}$		Q1	1.2	1.61	2.2	V
		$V_{GS} = V_{DS}, I_D = 270\text{ }\mu\text{A}$		Q2	1.2	1.64	2.2	
Negative Threshold Temperature Coefficient	$V_{GS(TH)}/T_J$	$I_D = 270\text{ }\mu\text{A}, \text{ ref to } 25^\circ\text{C}$		Q1		4.5		mV/°C
		$I_D = 270\text{ }\mu\text{A}, \text{ ref to } 25^\circ\text{C}$		Q2		4.5		
Drain-to-Source On Resistance	$R_{DS(on)}$	$V_{GS} = 10\text{ V}, I_D = 10\text{ A}$		Q1		3.8	4.3	m Ω
		$V_{GS} = 4.5\text{ V}, I_D = 10\text{ A}$					4.7	
		$V_{GS} = 10\text{ V}, I_D = 10\text{ A}$		Q2		2.9	3.5	
		$V_{GS} = 4.5\text{ V}, I_D = 10\text{ A}$					3.9	
Forward Transconductance	g_{FS}	$V_{DS} = 5\text{ V}, I_D = 10\text{ A}$		Q1		52		S
		$V_{DS} = 5\text{ V}, I_D = 10\text{ A}$		Q2		57		
Gate-Resistance	R_G	$T_A = 25^\circ\text{C}$		Q1		0.8		Ω
				Q2		0.8		

CHARGES AND CAPACITANCES

Input Capacitance	C_{ISS}	$V_{GS} = 0\text{ V}, V_{DS} = 15\text{ V}, f = 1\text{ MHz}$	Q1		1103		pF
			Q2		972		
Output Capacitance	C_{OSS}		Q1		335		pF
			Q2		309		
Reverse Transfer Capacitance	C_{RSS}		Q1		19		pF
			Q2		25		

Product parametric performance is indicated in the Electrical Characteristics for the listed test conditions, unless otherwise noted. Product performance may not be indicated by the Electrical Characteristics if operated under different conditions.

6. Pulse Test: pulse width $\leq 300\text{ }\mu\text{s}$, duty cycle $\leq 2\%$.

7. Switching characteristics are independent of operating junction temperatures.

NTTFD4D1N03P1E

ELECTRICAL CHARACTERISTICS (T_J = 25°C unless otherwise specified)

Parameter	Symbol	Test Condition	FET	Min	Typ	Max	Unit
CHARGES AND CAPACITANCES							
Total Gate Charge	Q _{G(TOT)}	Q1: V _{GS} = 4.5 V, V _{DS} = 15 V; I _D = 10 A Q2: V _{GS} = 4.5 V, V _{DS} = 15 V; I _D = 10 A	Q1		6.7		nC
			Q2		6.3		
Gate-to-Drain Charge	Q _{GD}		Q1		1.4		nC
			Q2		1.4		
Gate-to-Source Charge	Q _{GS}		Q1		2.8		nC
			Q2		2.5		
Total Gate Charge	Q _{G(TOT)}	Q1: V _{GS} = 10 V, V _{DS} = 15 V; I _D = 10 A	Q1		15		nC
		Q2: V _{GS} = 10 V, V _{DS} = 15 V; I _D = 10 A	Q2		14		

SWITCHING CHARACTERISTICS, V_{GS} = 4.5 V (Note 7)

Turn-On Delay Time	t _{d(ON)}	V _{GS} = 4.5 V Q1: I _D = 10 A, V _{DD} = 15 V, R _G = 6 Ω Q2: I _D = 10 A, V _{DD} = 15 V, R _G = 6 Ω	Q1		12		ns
			Q2		11		
Rise Time	t _r		Q1		7.5		ns
			Q2		5.2		
Turn-Off Delay Time	t _{d(OFF)}		Q1		16		ns
			Q2		14.3		
Fall Time	t _f	Q1		5.2		ns	
		Q2		4.9			

SWITCHING CHARACTERISTICS, V_{GS} = 10 V (Note 7)

Turn-On Delay Time	t _{d(ON)}	V _{GS} = 10 V Q1: I _D = 10 A, V _{DD} = 15 V, R _G = 6 Ω Q2: I _D = 10 A, V _{DD} = 15 V, R _G = 6 Ω	Q1		8.3		ns
			Q2		7.5		
Rise Time	t _r		Q1		2.0		ns
			Q2		1.8		
Turn-Off Delay Time	t _{d(OFF)}		Q1		22		ns
			Q2		20		
Fall Time	t _f	Q1		3.2		ns	
		Q2		3.0			

DRAIN-SOURCE DIODE CHARACTERISTICS

Forward Diode Voltage	V _{SD}	V _{GS} = 0 V, I _S = 10 A	T _J = 25°C	Q1		0.80	1.2	V
			T _J = 125°C			0.65		
		V _{GS} = 0 V, I _S = 10 A	T _J = 25°C	Q2		0.79	1.2	
			T _J = 125°C			0.65		
Reverse Recovery Time	t _{RR}	V _{GS} = 0 V, V _{DD} = 15 V Q1: I _S = 10 A, dI _S /dt = 100 A/μs Q2: I _S = 10 A, dI _S /dt = 100 A/μs	Q1		23		ns	
	Q2			22				
Reverse Recovery Charge	Q _{RR}		Q1		9.4		nC	
			Q2		9.0			

Product parametric performance is indicated in the Electrical Characteristics for the listed test conditions, unless otherwise noted. Product performance may not be indicated by the Electrical Characteristics if operated under different conditions.

6. Pulse Test: pulse width ≤ 300 μs, duty cycle ≤ 2%.

7. Switching characteristics are independent of operating junction temperatures.

NTTFD4D1N03P1E

TYPICAL CHARACTERISTICS – Q1

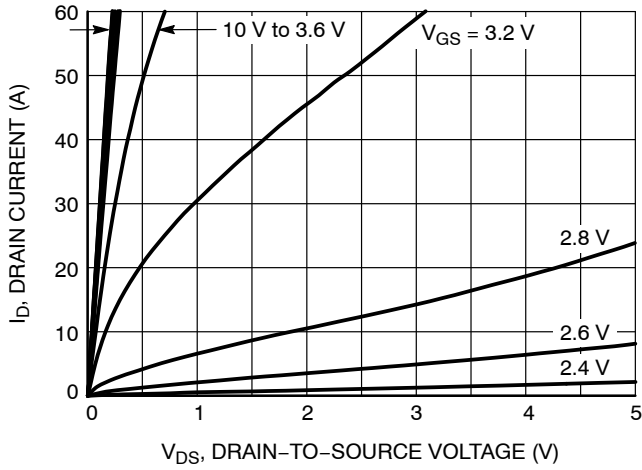

Figure 1. On-Region Characteristics

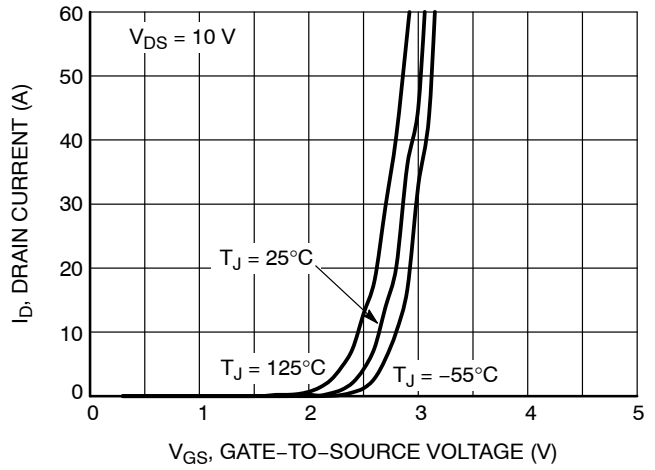

Figure 2. Transfer Characteristics

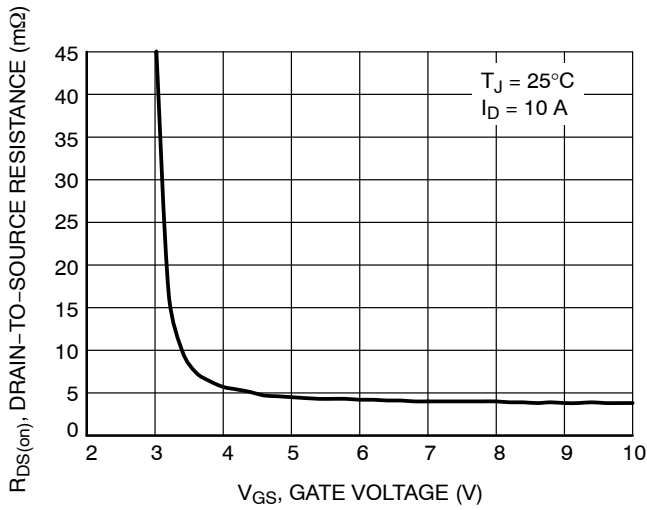

Figure 3. On-Resistance vs. Gate-to-Source Voltage

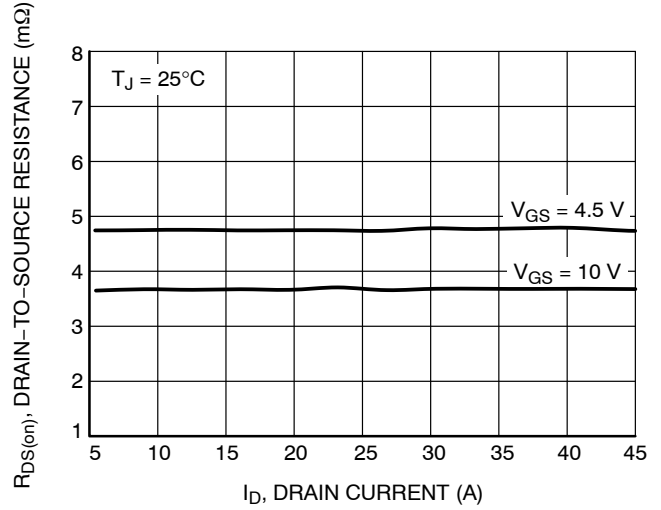

Figure 4. On-Resistance vs. Drain Current and Gate Voltage

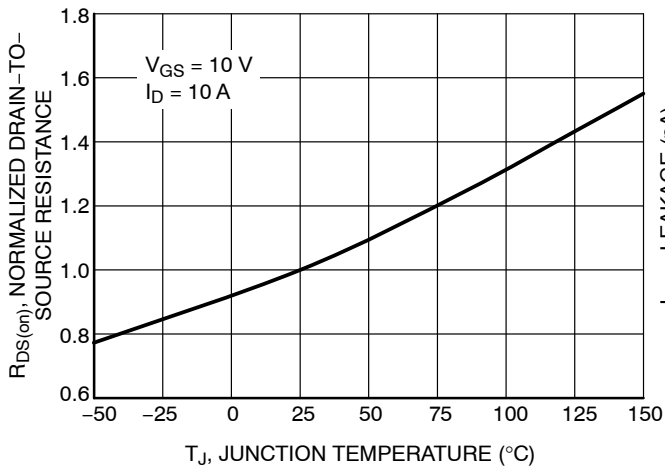

Figure 5. On-Resistance Variation with Temperature

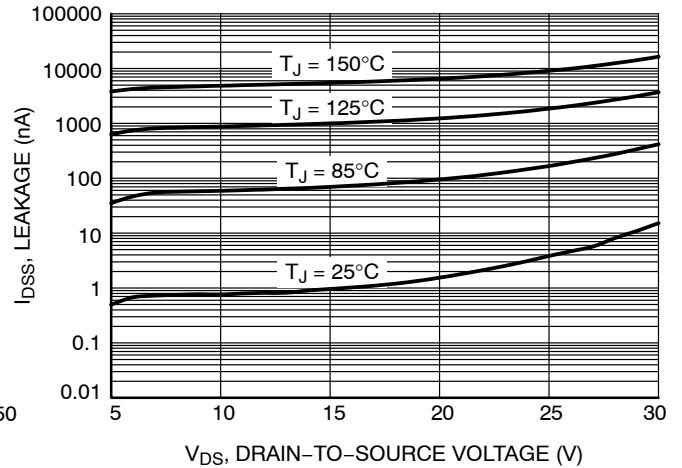

Figure 6. Drain-to-Source Leakage Current vs. Voltage

NTTFD4D1N03P1E

TYPICAL CHARACTERISTICS – Q1

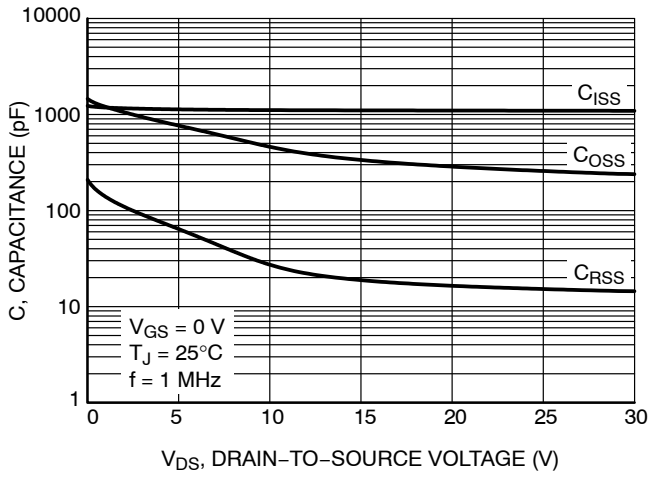

Figure 7. Capacitance Variation

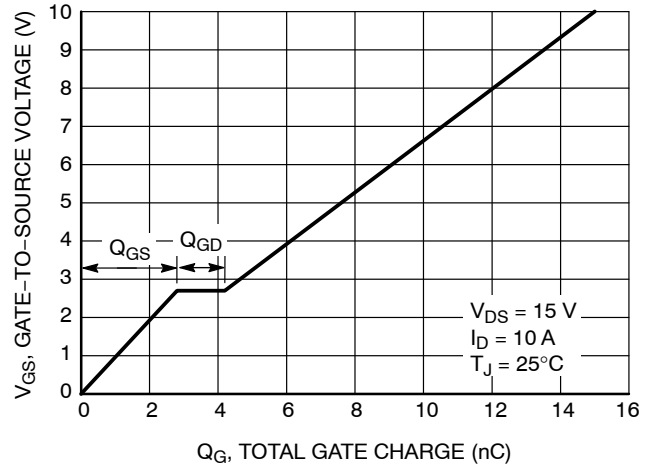

Figure 8. Gate-to-Source and Drain-to-Source Voltage vs. Total Charge

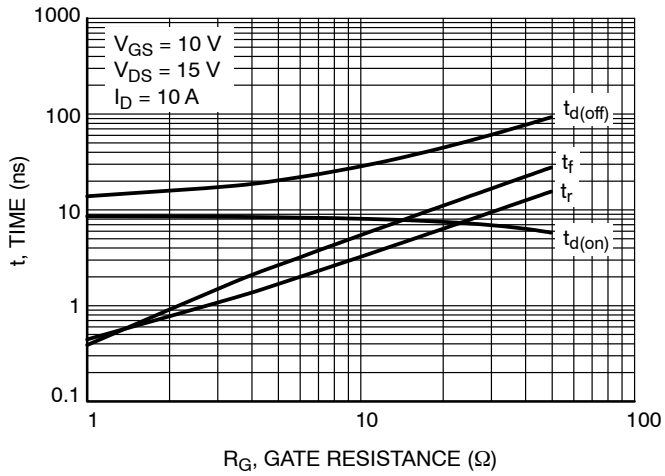

Figure 9. Resistive Switching Time Variation vs. Gate Resistance

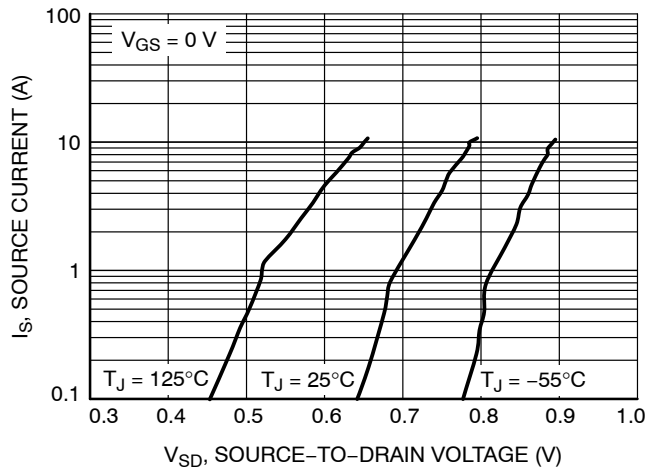

Figure 10. Diode Forward Voltage vs. Current

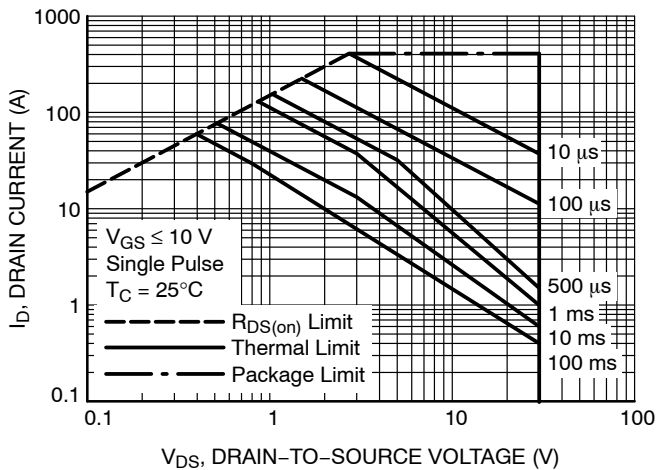

Figure 11. Maximum Rated Forward Biased Safe Operating Area

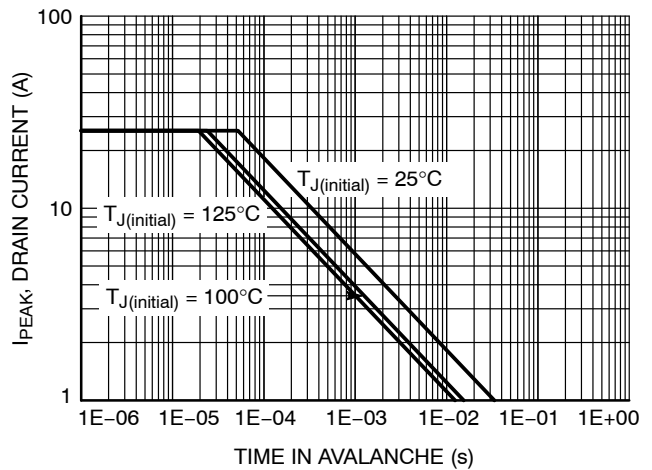

Figure 12. Maximum Drain Current vs. Time in Avalanche

NTTFD4D1N03P1E

TYPICAL CHARACTERISTICS – Q1

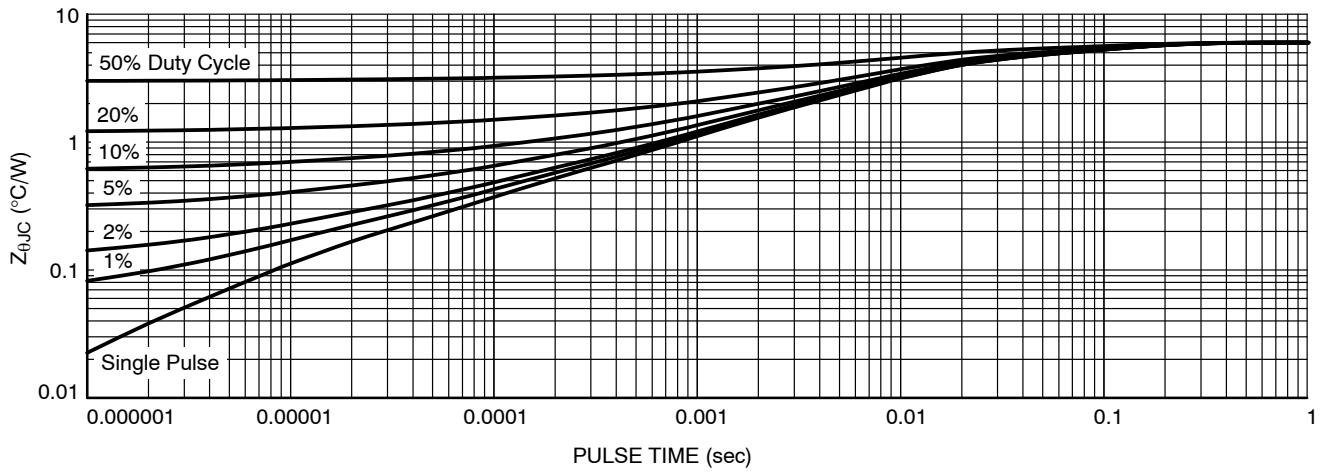

Figure 13. Thermal Characteristics

NTTFD4D1N03P1E

TYPICAL CHARACTERISTICS – Q2

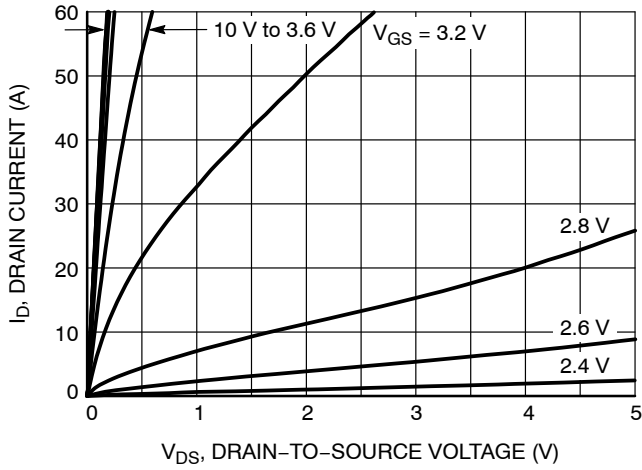

Figure 14. On-Region Characteristics

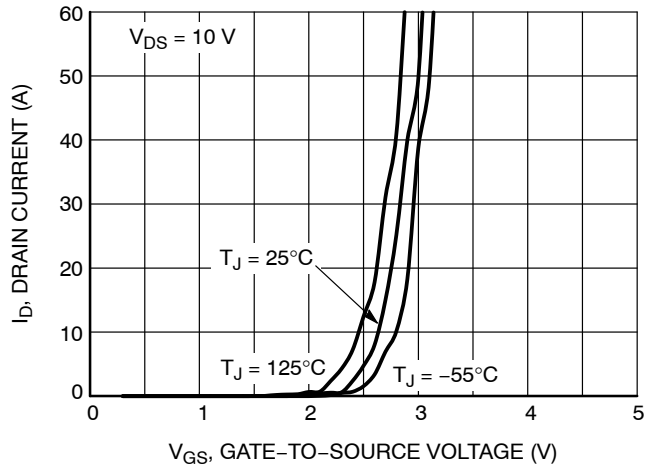

Figure 15. Transfer Characteristics

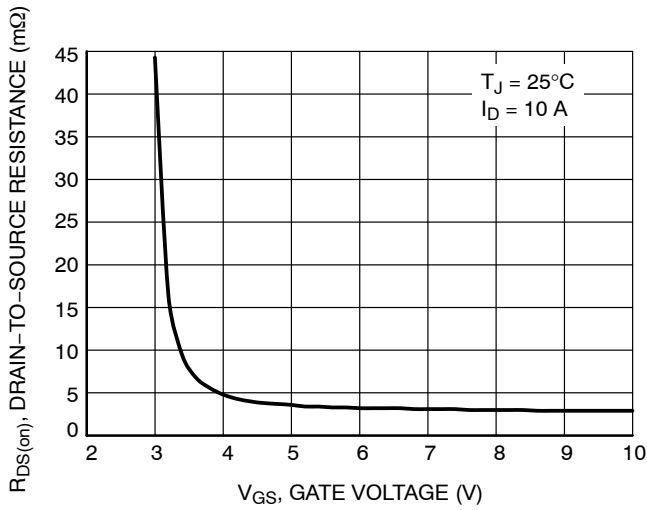

Figure 16. On-Resistance vs. Gate-to-Source Voltage

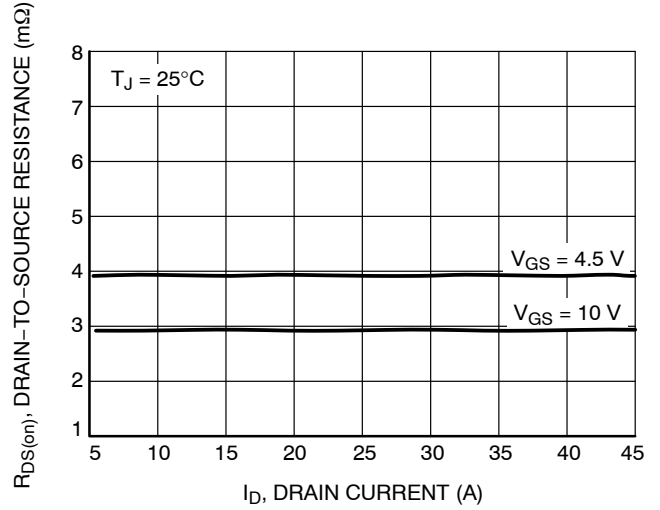

Figure 17. On-Resistance vs. Drain Current and Gate Voltage

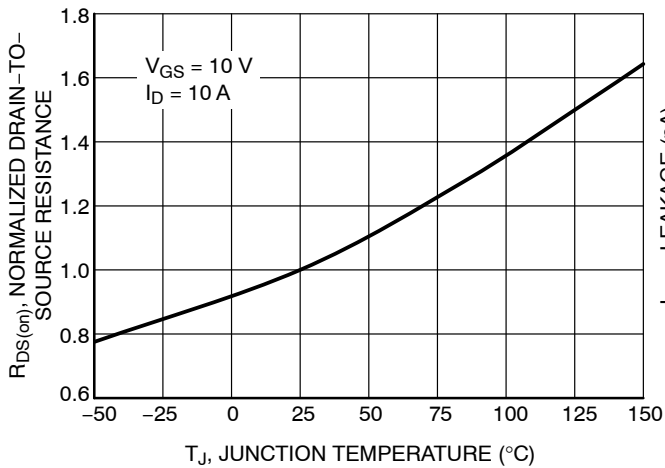

Figure 18. On-Resistance Variation with Temperature

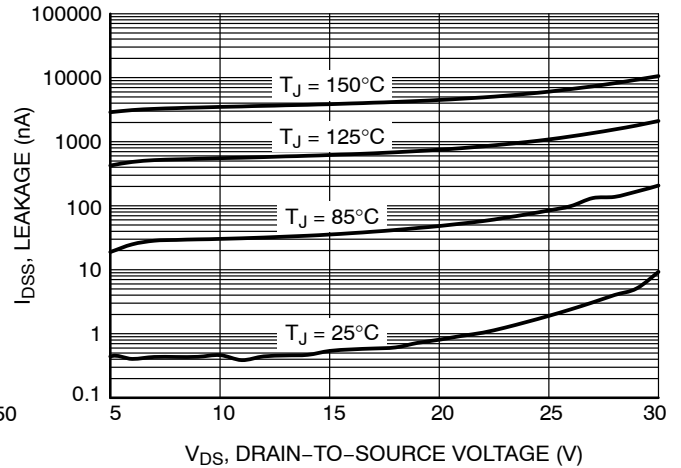

Figure 19. Drain-to-Source Leakage Current vs. Voltage

NTTFD4D1N03P1E

TYPICAL CHARACTERISTICS – Q2

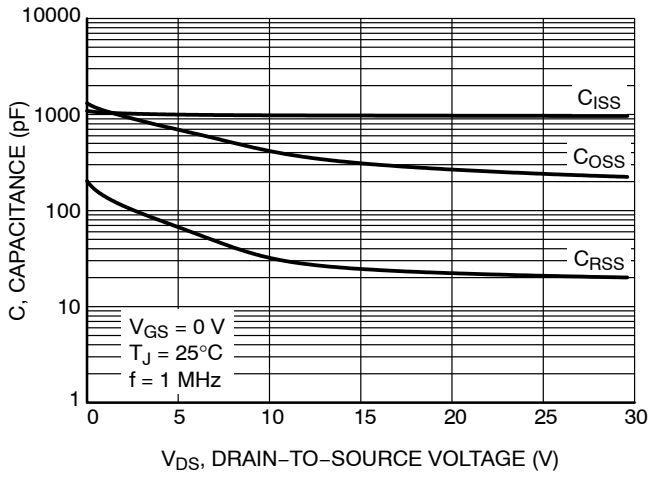

Figure 20. Capacitance Variation

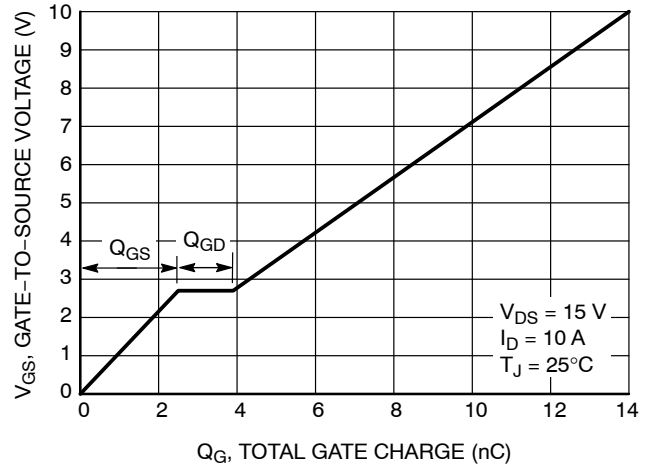

Figure 21. Gate-to-Source and Drain-to-Source Voltage vs. Total Charge

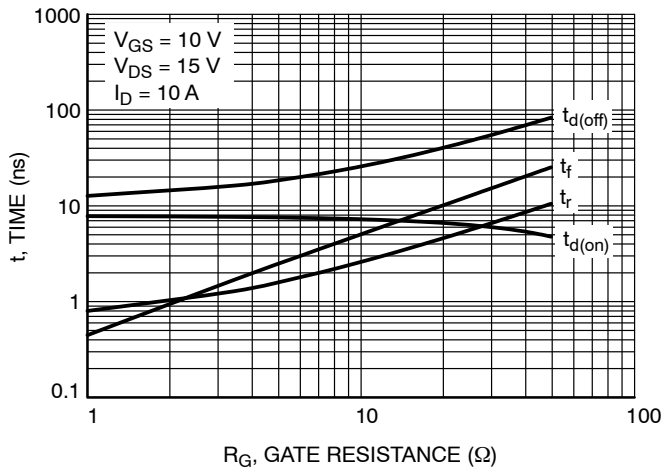

Figure 22. Resistive Switching Time Variation vs. Gate Resistance

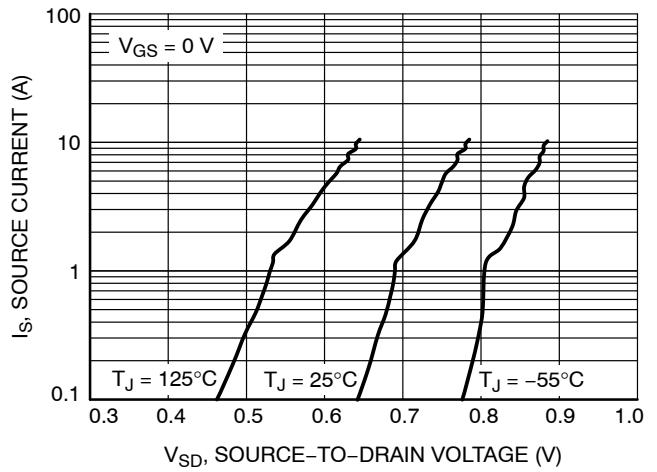

Figure 23. Diode Forward Voltage vs. Current

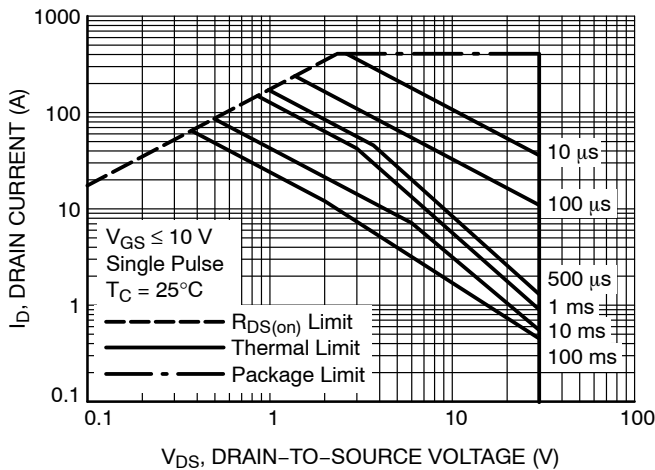

Figure 24. Maximum Rated Forward Biased Safe Operating Area

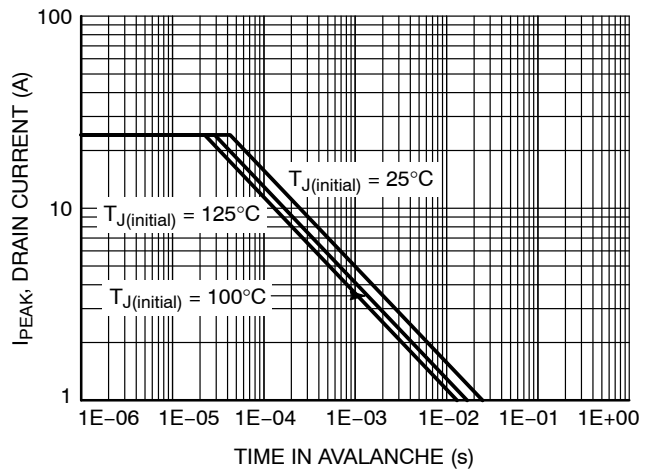

Figure 25. Maximum Drain Current vs. Time in Avalanche

NTTFD4D1N03P1E

TYPICAL CHARACTERISTICS – Q2

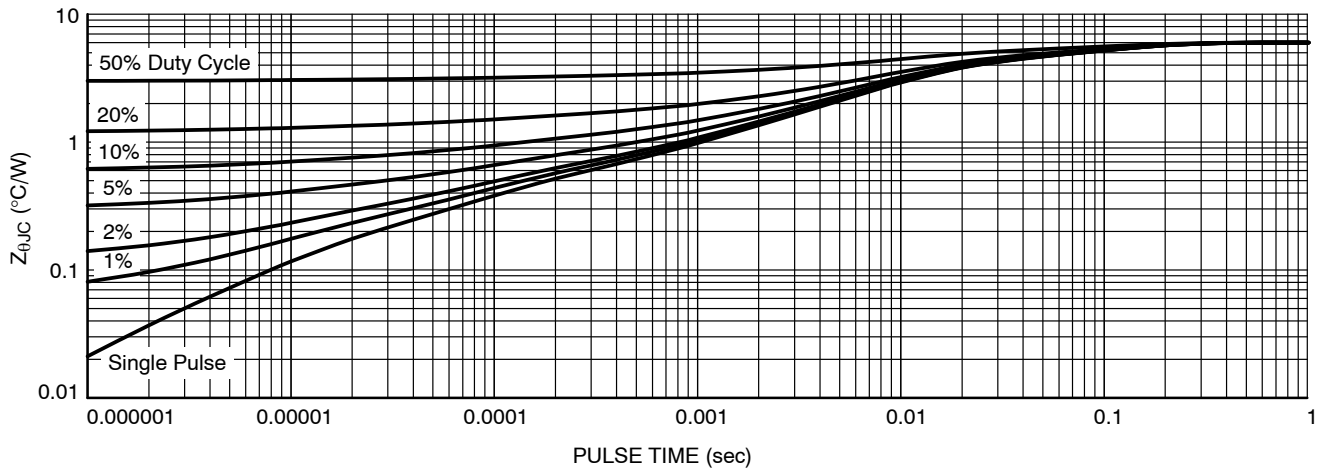
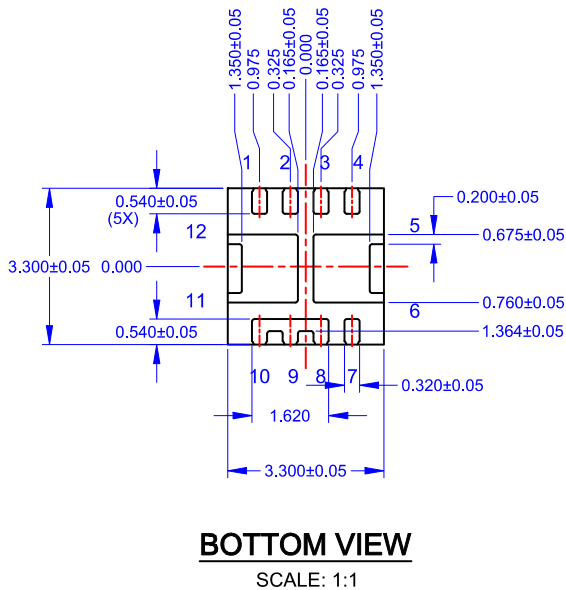
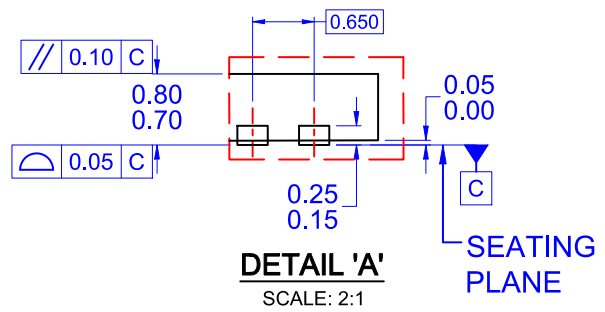
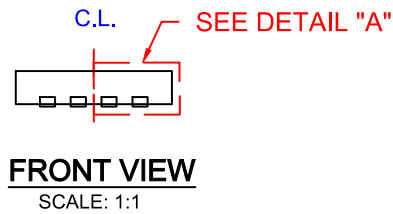
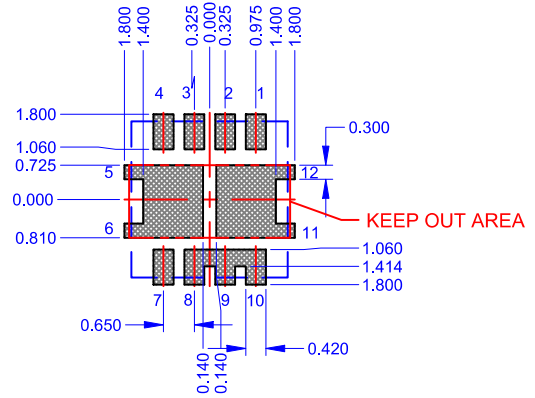
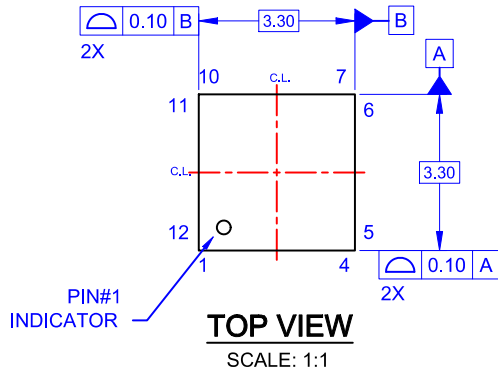

Figure 26. Thermal Characteristics

NTTFD4D1N03P1E

PACKAGE DIMENSIONS

WQFN12 3.3X3.3, 0.65P
CASE 510CJ
ISSUE O



NOTES: UNLESS OTHERWISE SPECIFIED

- A) DRAWING DOES NOT FULLY CONFORM TO JEDEC REGISTRATION MO-220, VARIATION WECC-1
- B) ALL DIMENSIONS ARE IN MILLIMETERS.
- C) DIMENSIONS DO NOT INCLUDE BURRS OR MOLD FLASH. MOLD FLASH OR BURRS DOES NOT EXCEED 0.10MM.

NTTFD4D1N03P1E

onsemi, **Onsemi**, and other names, marks, and brands are registered and/or common law trademarks of Semiconductor Components Industries, LLC dba "**onsemi**" or its affiliates and/or subsidiaries in the United States and/or other countries. **onsemi** owns the rights to a number of patents, trademarks, copyrights, trade secrets, and other intellectual property. A listing of **onsemi**'s product/patent coverage may be accessed at www.onsemi.com/site/pdf/Patent-Marking.pdf. **onsemi** reserves the right to make changes at any time to any products or information herein, without notice. The information herein is provided "as-is" and **onsemi** makes no warranty, representation or guarantee regarding the accuracy of the information, product features, availability, functionality, or suitability of its products for any particular purpose, nor does **onsemi** assume any liability arising out of the application or use of any product or circuit, and specifically disclaims any and all liability, including without limitation special, consequential or incidental damages. Buyer is responsible for its products and applications using **onsemi** products, including compliance with all laws, regulations and safety requirements or standards, regardless of any support or applications information provided by **onsemi**. "Typical" parameters which may be provided in **onsemi** data sheets and/or specifications can and do vary in different applications and actual performance may vary over time. All operating parameters, including "Typicals" must be validated for each customer application by customer's technical experts. **onsemi** does not convey any license under any of its intellectual property rights nor the rights of others. **onsemi** products are not designed, intended, or authorized for use as a critical component in life support systems or any FDA Class 3 medical devices or medical devices with a same or similar classification in a foreign jurisdiction or any devices intended for implantation in the human body. Should Buyer purchase or use **onsemi** products for any such unintended or unauthorized application, Buyer shall indemnify and hold **onsemi** and its officers, employees, subsidiaries, affiliates, and distributors harmless against all claims, costs, damages, and expenses, and reasonable attorney fees arising out of, directly or indirectly, any claim of personal injury or death associated with such unintended or unauthorized use, even if such claim alleges that **onsemi** was negligent regarding the design or manufacture of the part. **onsemi** is an Equal Opportunity/Affirmative Action Employer. This literature is subject to all applicable copyright laws and is not for resale in any manner.

PUBLICATION ORDERING INFORMATION

LITERATURE FULFILLMENT:

Email Requests to: orderlit@onsemi.com

onsemi Website: www.onsemi.com

TECHNICAL SUPPORT

North American Technical Support:

Voice Mail: 1 800-282-9855 Toll Free USA/Canada

Phone: 011 421 33 790 2910

Europe, Middle East and Africa Technical Support:

Phone: 00421 33 790 2910

For additional information, please contact your local Sales Representative