



# Automotive Signal Common Mode Chokes

**ACMS-Q4528**

Request Samples



Check Inventory



4.5 x 3.2 x 2.8 mm  
RoHS/RoHS II Compliant  
MSL Level = 1

## Features

- AEC-Q200 compliant
- PPAP ready and supported
- Manufactured in TS/IATF 16949 production lines
- Excellent impedance characteristics
- Inductance values from 11  $\mu$ H to 100  $\mu$ H

## Applications

- Differential signal line common mode noise suppression.
- Multimedia devices
- Automotive applications such as ADAS, Infotainment, Sensing, TCU

## Electrical Specifications

Part Number	Impedance ( $\Omega$ ) @10MHz		Inductance ( $\mu$ H) (+50/-30%)	DCR (m $\Omega$ )	Rated Current (A)	Rated Voltage (Vdc)	Insulation Resistance (M $\Omega$ )
	Min	Typ.		Max	Max	Max	Min
ACMS-Q4528-110	300	600	11	600	0.36	50	10
ACMS-Q4528-220	500	1200	22	1000	0.31	50	10
ACMS-Q4528-510	1000	2800	51	1000	0.23	50	10
ACMS-Q4528-101	2000	5800	100	2000	0.20	50	10

**Rated Current is based on an Irms temperature rise of 40°C**

**Inductance Test Conditions: 0.1V, 100KHz**

**ACMS-Q4528 is AEC-Q200 Automotive certified**

**ACMS-Q4528 Series is RoHS Compliant and Pb free**

**Operating Temperature: -55°C to +150°C (Including self-heating)**

**Storage Temperature (on PCB): -55°C to +150°C**

**Storage (in original packaging): <40°C, <60% RH**



5101 Hidden Creek Ln, Spicewood TX 78669  
Phone: 512-371-6159 Fax: 512-351-8858  
For terms and conditions of sales, please visit:  
www.abracon.com

**REVISION Initial Release**  
3/31/2022

ABRACON IS  
ISO9001-2015  
CERTIFIED



# Automotive Signal Common Mode Chokes

**ACMS-Q4528**

Request Samples



Check Inventory



4.5 x 3.2 x 2.8 mm  
RoHS/RoHS II Compliant  
MSL Level = 1

## Electrical Specifications

**ACMS-Q4528-110**

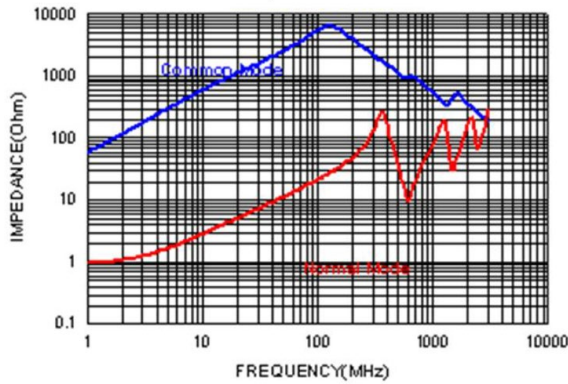

**ACMS-Q4528-220**

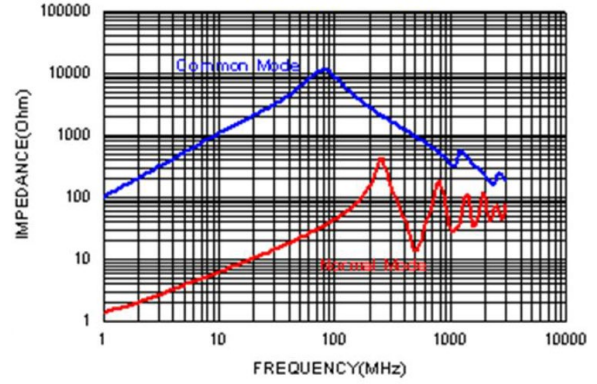

**ACMS-Q4528-510**

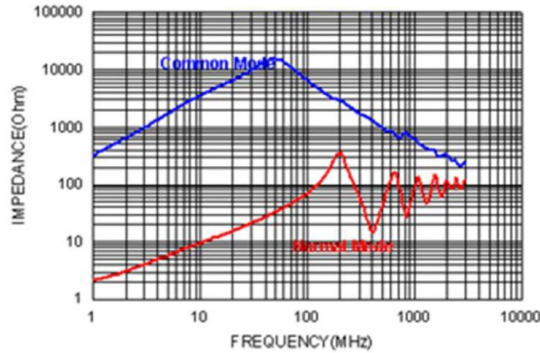

**ACMS-Q4528-101**

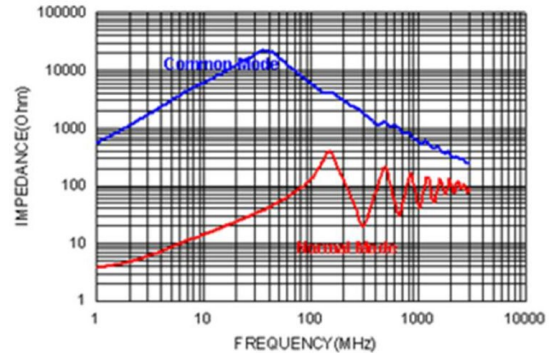

5101 Hidden Creek Ln, Spicewood TX 78669  
Phone: 512-371-6159 Fax: 512-351-8858  
For terms and conditions of sales, please visit:  
[www.abracon.com](http://www.abracon.com)

**REVISION Initial Release**  
3/31/2022

ABRACON IS  
ISO9001-2015  
CERTIFIED



# Automotive Signal Common Mode Chokes

ACMS-Q4528

Request Samples

Check Inventory

4.5 x 3.2 x 2.8 mm  
**RoHS/RoHS II Compliant**  
 MSL Level = 1

## Mechanical Specifications

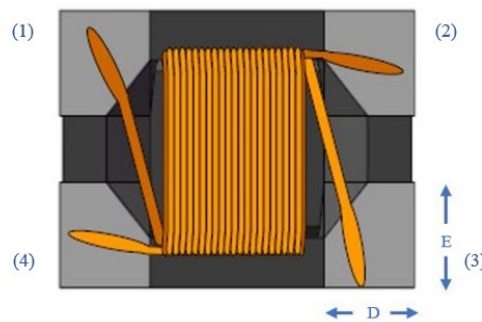
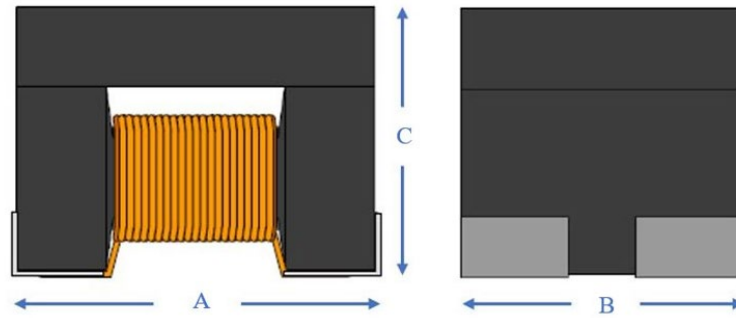

A	B	C	D	E
4.5 ±0.2	3.2 ±0.2	2.8 ±0.2	0.75 ±0.2	0.85 ±0.2

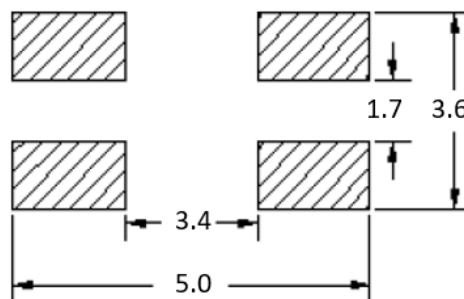

## Recommended Layout

Dimensions: mm



5101 Hidden Creek Ln, Spicewood TX 78669  
 Phone: 512-371-6159 Fax: 512-351-8858  
 For terms and conditions of sales, please visit:  
[www.abracon.com](http://www.abracon.com)

**REVISION Initial Release**  
 3/31/2022

ABRACON IS  
 ISO9001-2015  
 CERTIFIED



# Automotive Signal Common Mode Chokes

**ACMS-Q4528**

Request Samples



Check Inventory



4.5 x 3.2 x 2.8 mm  
**RoHS/RoHS II Compliant**  
 MSL Level = 1

## Schematic

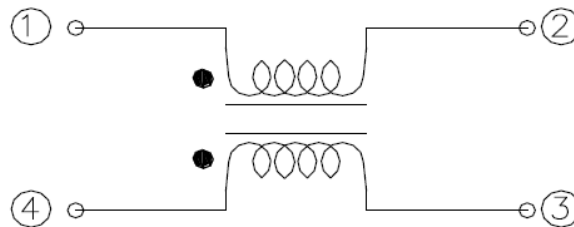

## Materials

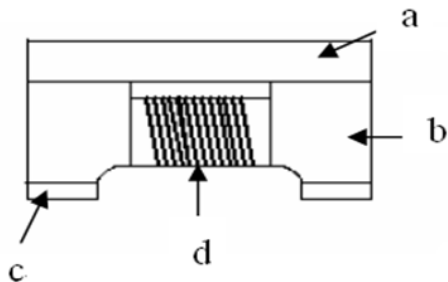

	Description	Specification
a	Upper Plate	Ferrite
b	Core	Ferrite Core
c	Electrode	Ag/Ni/Sn
d	Wire	Enameled Copper Wire

## Part Identification

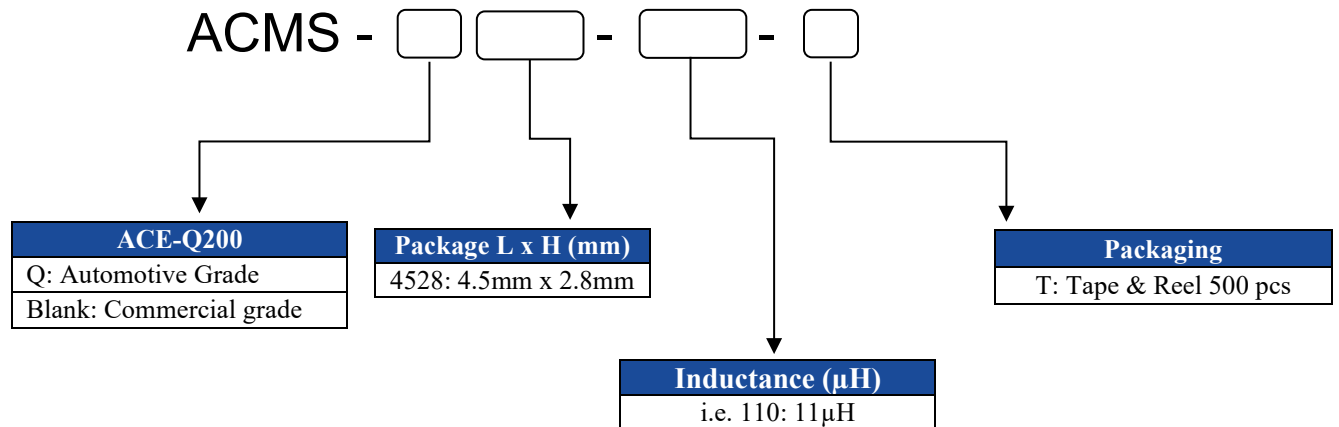



# Automotive Signal Common Mode Chokes

ACMS-Q4528

Request Samples



Check Inventory



4.5 x 3.2 x 2.8 mm  
 RoHS/RoHS II Compliant  
 MSL Level = 1

## Reflow Profile

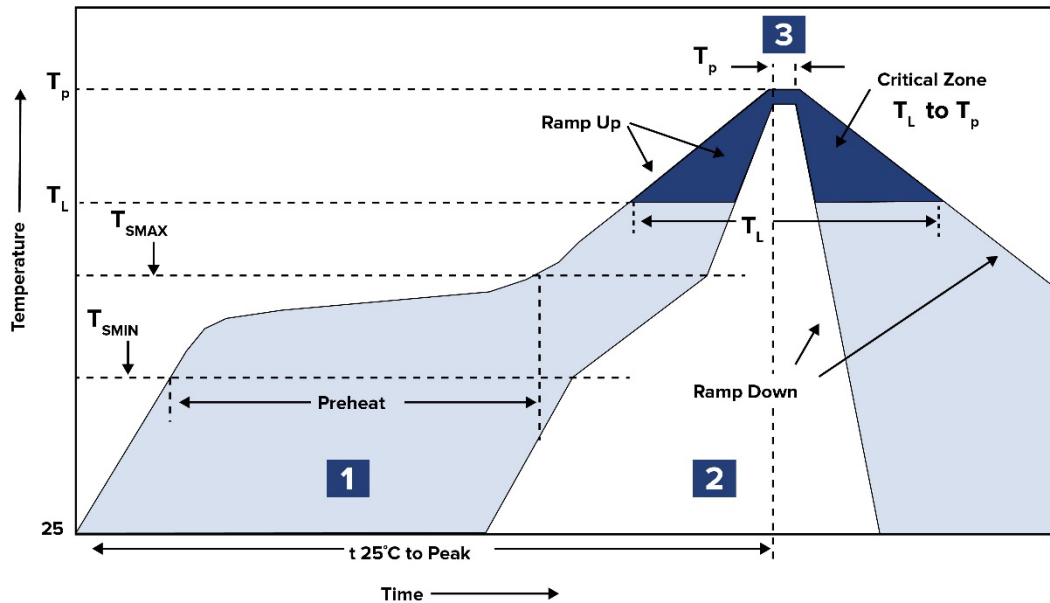

Zone	Description	Temperature	Times
1	Preheat	$T_{SMIN} \sim T_{SMAX}$ 150°C ~ 200°C	60 ~ 180 sec.
2	Reflow	$T_L$ 217°C	60 ~ 150 sec.
3	Peak heat	$T_p$ 250°C ±5°C	30 sec. MAX



# Automotive Signal Common Mode Chokes

**ACMS-Q4528**

Request Samples



Check Inventory



4.5 x 3.2 x 2.8 mm  
**RoHS/RoHS II Compliant**  
 MSL Level = 1

## Packaging

**Tape & Reel: 500pcs/reel**

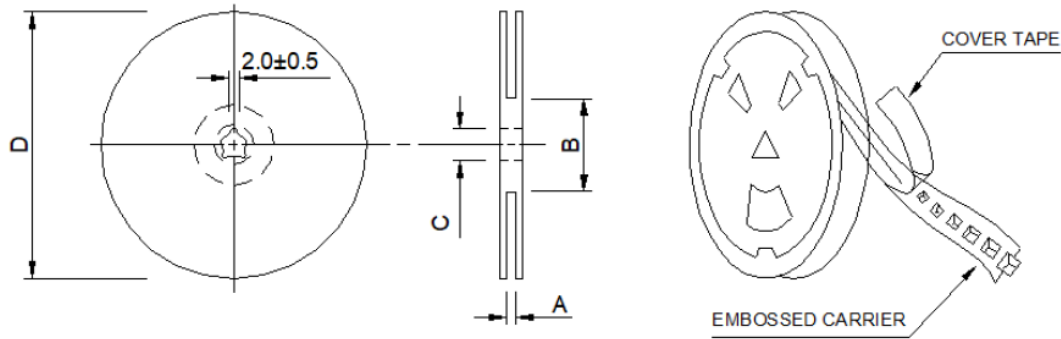

Series	A	B	C	D
ACMS-Q4528	$13.5 \pm 0.5$	$60.0 \pm 2.0$	$13.5 \pm 0.5$	$178 \pm 2.0$

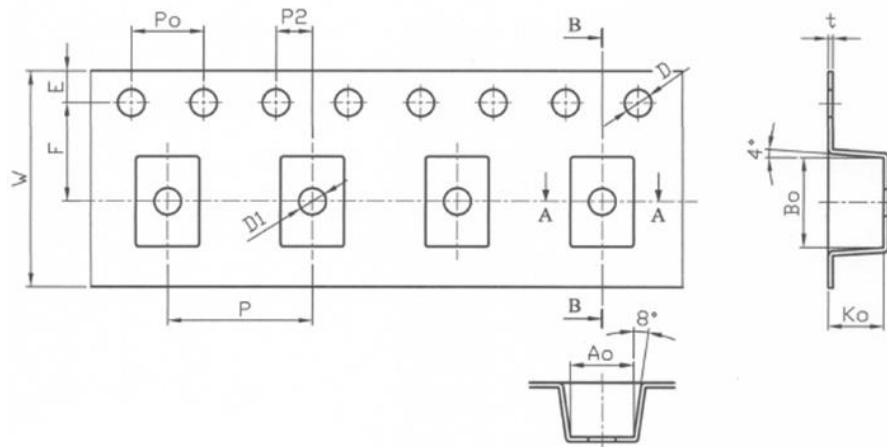

W	P	E	F	P0	P2	B0	A0	K0	D	D1	t
12.0 $\pm 0.10$	8.0 $\pm 0.10$	1.75 $\pm 0.10$	5.5 $\pm 0.10$	4.0 $\pm 0.10$	2.0 $\pm 0.10$	4.9 $\pm 0.10$	3.6 $\pm 0.10$	3.0 $\pm 0.10$	1.5 $+0.10/-0$	1.5 $\pm 0.10$	0.26 $\pm 0.05$

Dimensions: mm

**ATTENTION:** Abracon LLC's products are COTS – Commercial-Off-The-Shelf products; suitable for Commercial, Industrial and, where designated, Automotive Applications. Abracon's products are not specifically designed for Military, Aviation, Aerospace, Life-dependent Medical applications or any application requiring high reliability where component failure could result in loss of life and/or property. For applications requiring high reliability and/or presenting an extreme operating environment, written consent and authorization from Abracon LLC is required. Please contact Abracon LLC for more information.



5101 Hidden Creek Ln, Spicewood TX 78669  
 Phone: 512-371-6159 Fax: 512-351-8858  
 For terms and conditions of sales, please visit:  
[www.abracon.com](http://www.abracon.com)

**REVISION Initial Release**  
 3/31/2022

ABRACON IS  
 ISO9001-2015  
 CERTIFIED