

**Contact Code**

503-Fork Tail .115x.025(2.92x0.64) - Tail LG.=.398(10.11)

THIS IS A C.A.D. GENERATED DRAWING  
DO NOT MAKE MANUAL REVISIONS TO MASTER



ISSUE NUMBER

ORIGINAL

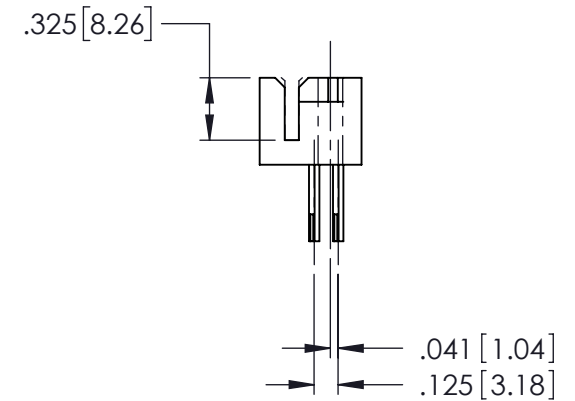
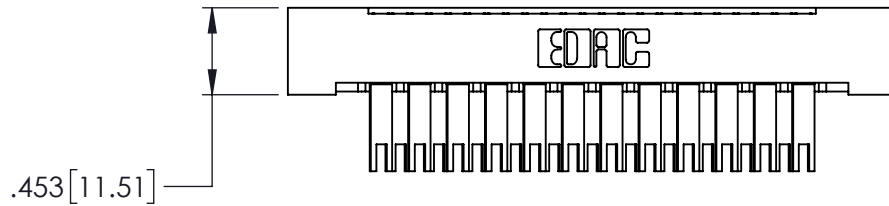
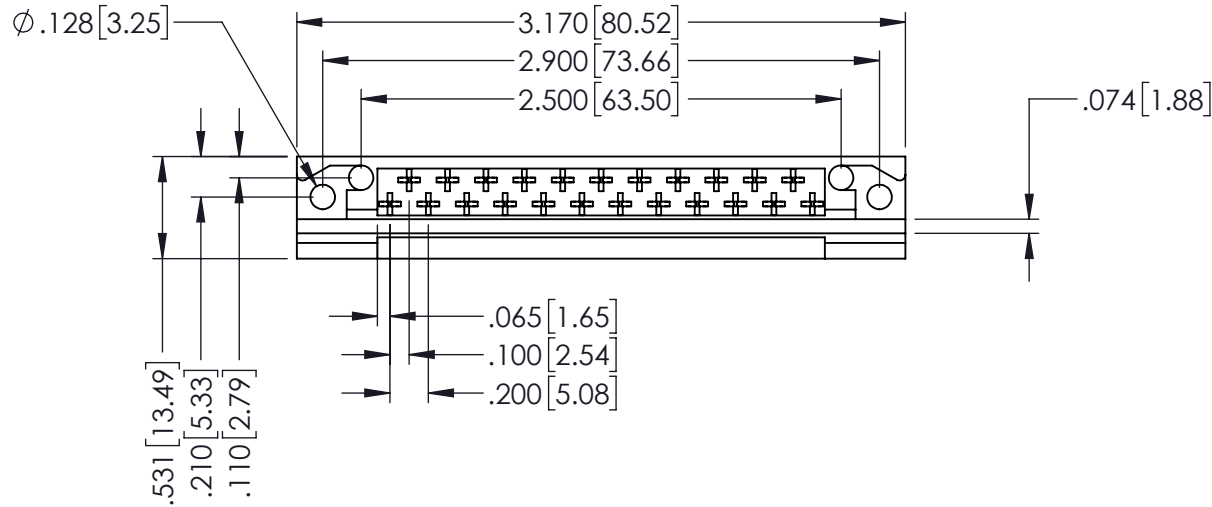

408/424 Series High Reliability Interlock Connector  
PART NUMBER: 424-023-503-112



YOUR CONNECTION TO QUALITY & SERVICE

EDAC INC  
TORONTO, ONTARIO  
CANADA

THESE DRAWINGS AND SPECIFICATIONS  
ARE THE PROPERTY OF EDAC INC. AND  
SHALL NOT BE REPRODUCED, OR COPIED  
OR USED AS THE BASIS FOR THE  
MANUFACTURE OR SALE OF APPARATUS  
WITHOUT WRITTEN PERMISSION.

ACAD REFERENCE NO. 408-ENG-MASTER

DRAWN: J.LEE DATE: SEPT. 16/09

CHECKED: DATE:

SCALE: NTS SHEET 1 OF 1

DRAWING NUMBER  
408-ENG-MASTER

ISSUE  
1