

Product brief

TLE94x03EP, TLE94x04EP

3- and 4-fold integrated half-bridge driver IC

The TLE94x03EP and TLE94x04EP are protected 3- and 4-fold half-bridge drivers designed for automotive motion control applications such as mirror x-y-adjustment and DC flap motors for Heating, Ventilation and Air Conditioning systems (HVAC). The devices are part of a family which includes also 6-, 8-, 10-, and 12-fold half-bridge driver ICs. The devices can drive DC motor loads up to 0.9 A per half-bridge in cascaded or parallel operation. They offer diagnosis features such as short circuit, open load, power supply failure and over-temperature detection to ensure safe operation. In combination with their low quiescent current and very small package they are attractive for automotive and other applications.

Key features

- > 3- and 4-half-bridges with integrated output stages and PWM capability
- > 16-bit SPI or DI for control and diagnosis
- > Voltage supply range: 5.5–20 V

Key benefits

- > Variable driving schemes for up to 3 motors
- > Control and diagnosis of each output via SPI or DI
- > Device operates down to 5.5 V (supporting start stop system of fuel efficient vehicles)

Applications

- > Mirror x-y-adjustment
- > Flap motor for HVAC systems
- > Bi-stable relays
- > Small DC motors (up to 0.9 A/half-bridge)

Block diagram 4-fold half-bridge with direct interface

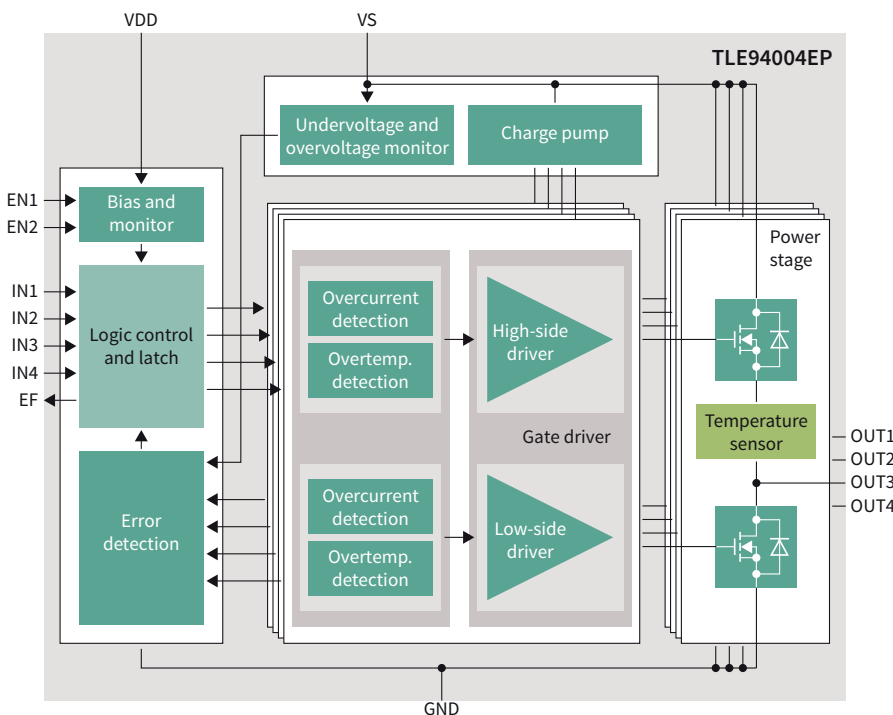

TLE94x03EP, TLE94x04EP

3- and 4-fold integrated half-bridge driver IC

Application diagram 4-fold half-bridge

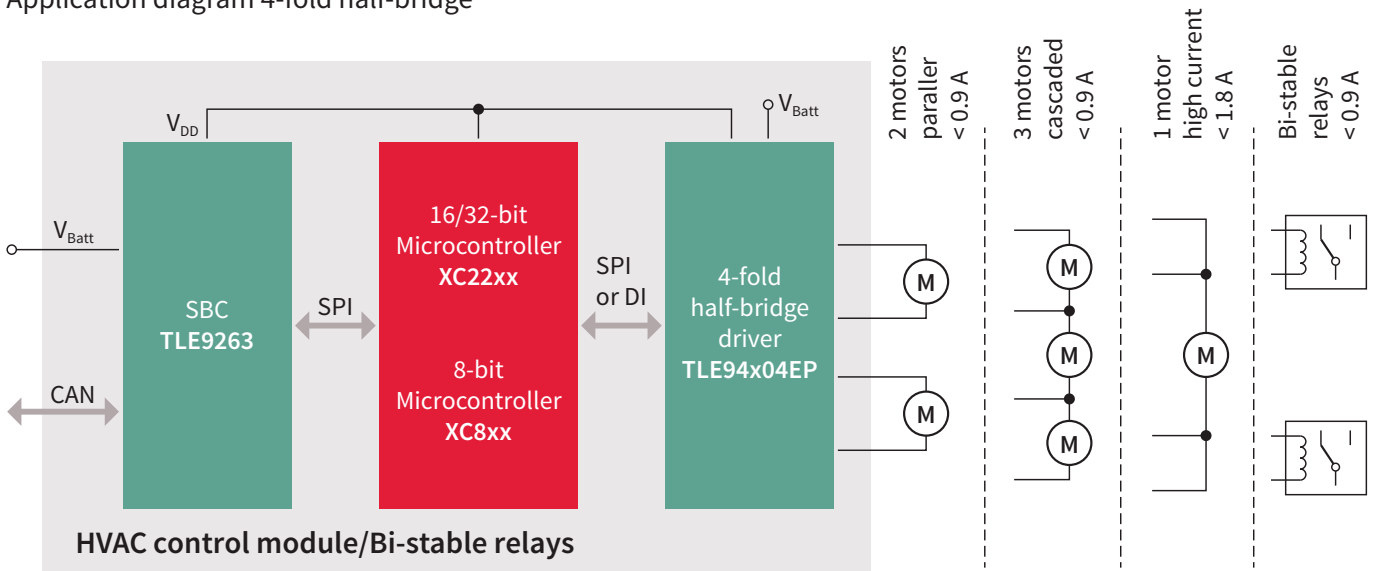

The TLE94x03EP is designed to drive 2 DC motors with loads up to 0.9 A in cascaded mode while the TLE94x04EP can either drive 2 DC motors in parallel or up to 3 motors in cascaded mode (see application diagram). Both devices can also be used to drive bi-stable relays. The devices are sold in a TSDSO-14 package and are pin and function compatible with each other. The package enables compact/space saving designs with a minimum footprint of 19 mm².

Both types (3- and 4-fold bridge driver) are available either with a direct interface (DI) or a 16-bit SPI interface (see overview with ordering codes below). The DI offers basic control and diagnostics, while the SPI offer control and detailed diagnosis of each half-bridge. Using the SPI version all outputs can be programmed for PWM and the user can select between active and passive free-wheeling for each output. The device can be operated in a daisy chain mode.

Product summary

Type	Description	Ordering code
TLE94003EP	3-fold integrated half-bridge driver IC with DI	SP001256576
TLE94103EP	3-fold integrated half-bridge driver IC with SPI	SP001256580
TLE94004EP	4-fold integrated half-bridge driver IC with DI	SP001256578
TLE94104EP	4-fold integrated half-bridge driver IC with SPI	SP001256582

Published by
Infineon Technologies AG
81726 Munich, Germany

© 2021 Infineon Technologies AG.
All Rights Reserved.

Please note!

This Document is for information purposes only and any information given herein shall in no event be regarded as a warranty, guarantee or description of any functionality, conditions and/or quality of our products or any suitability for a particular purpose. With regard to the technical specifications of our products, we kindly ask you to refer to the relevant product data sheets provided by us. Our customers and their technical departments are required to evaluate the suitability of our products for the intended application.

We reserve the right to change this document and/or the information given herein at any time.

Additional information

For further information on technologies, our products, the application of our products, delivery terms and conditions and/or prices, please contact your nearest Infineon Technologies office (www.infineon.com).

Warnings

Due to technical requirements, our products may contain dangerous substances. For information on the types in question, please contact your nearest Infineon Technologies office.

Except as otherwise explicitly approved by us in a written document signed by authorized representatives of Infineon Technologies, our products may not be used in any life-endangering applications, including but not limited to medical, nuclear, military, life-critical or any other applications where a failure of the product or any consequences of the use thereof can result in personal injury.