

Collin's Lab: Breadboards & Perfboards

Created by Collin Cunningham

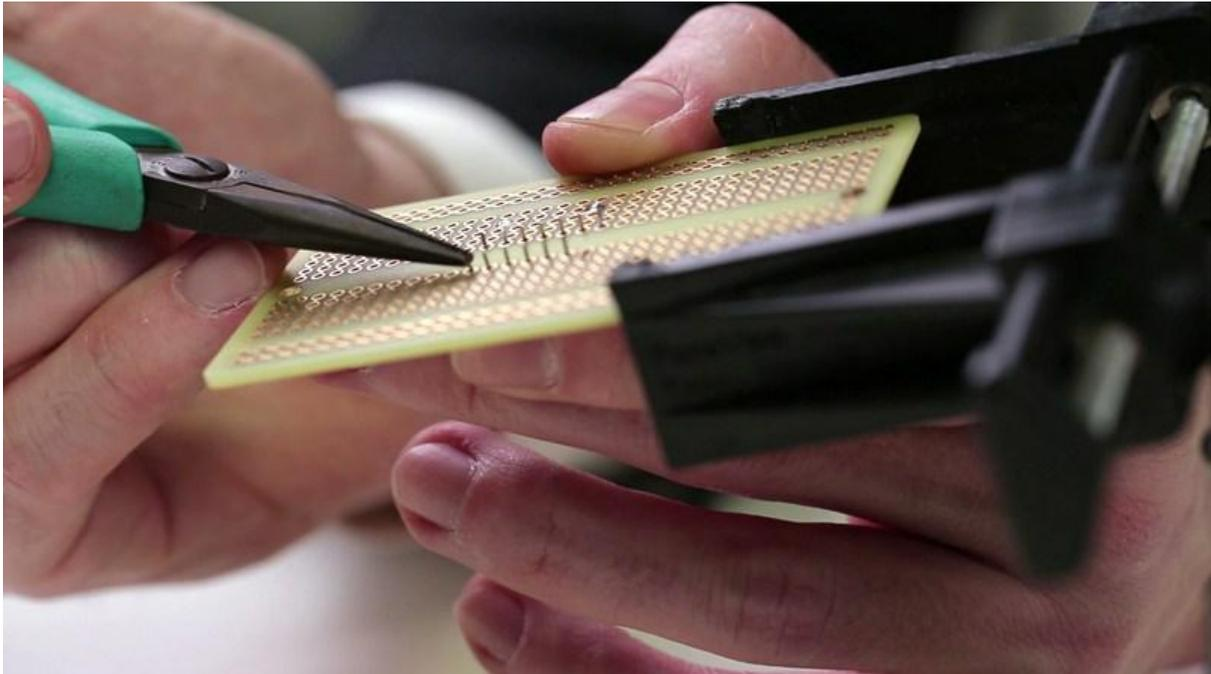

<https://learn.adafruit.com/collins-lab-breadboards-and-perfboards>

Last updated on 2022-12-01 02:12:24 PM EST

Table of Contents

Video	3
Transcript	3
Learn More	11
<ul style="list-style-type: none">• Breadboard• Perfboard	

Video

A circuit can live in many forms – most of them being ‘board’ forms. Likely the two most important for DIYers are the easily-modifiable breadboard and resilient yet still versatile perfboard. Taking a design from schematic to breadboard, and subsequently perfboard, is a vital process to the electronics maker – learn it, live it, love it!

Transcript

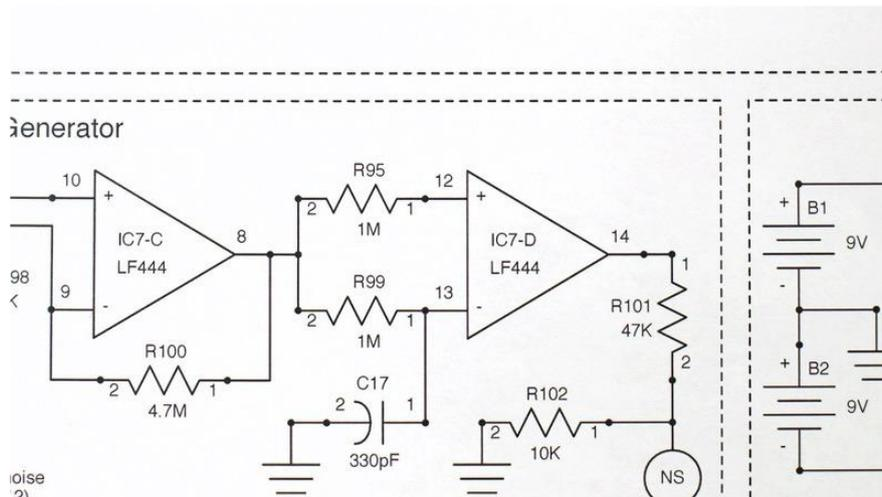

Circuit schematics are very nice things ... all these components floating in a lovely two-dimensional world with ideal placement & perfect connections ... a nice idea.

But eventually ... we have to make them real.

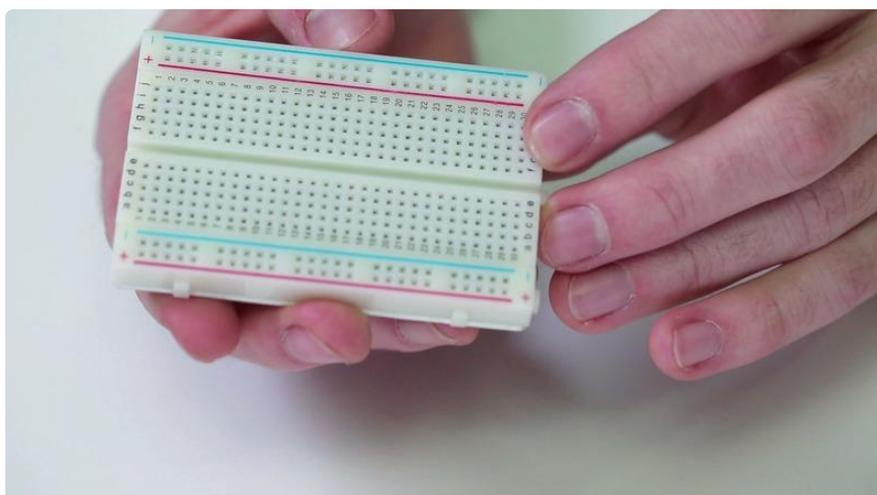

And in reality, a circuit usually exists on some type of circuit board - like say, a breadboard for example.

Breadboards offer the most flexible way to assemble a circuit - build it, change it, scrap it, start over - all good, breadboard don't mind at all.

And that's because it doesn't require any soldering.

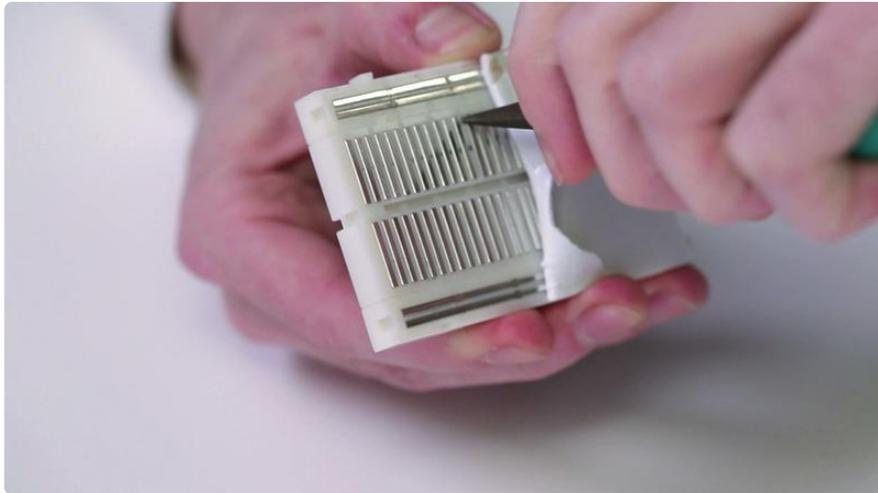

Beneath all those holes, a breadboard houses an army of springy metal clips which hold component leads in place while providing electrical connections between them.

... though you may want to avoid taking one apart.

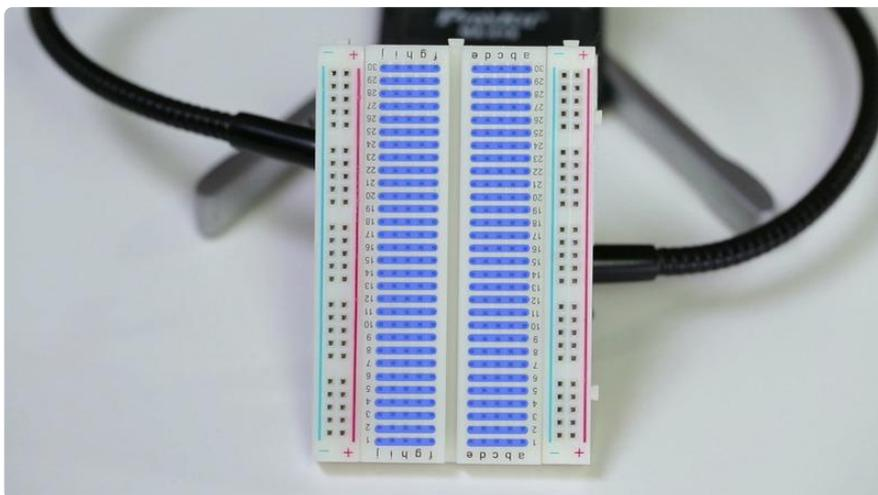

When we place a component on a breadboard, we're essentially wiring it into one of those internally connected rows.

The two inner columns connect components horizontally

That split down the center makes it easy to place an IC on a breadboard while keeping its pins electrically separated from one another.

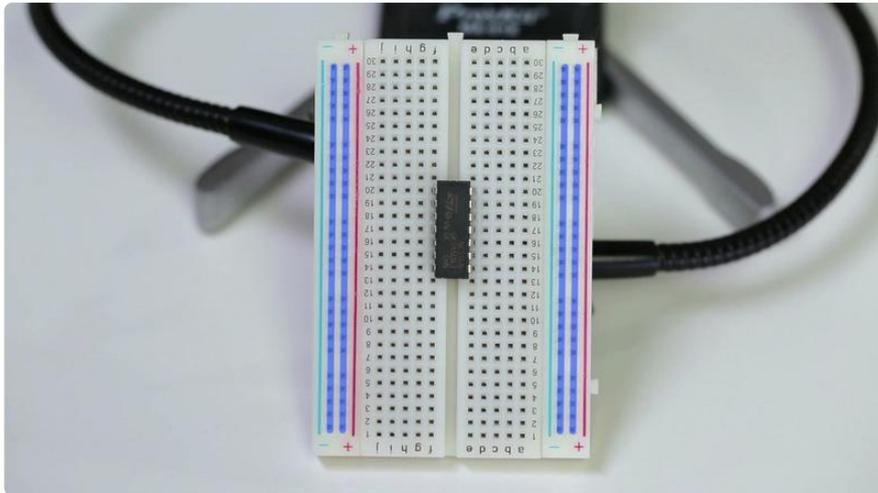

The two columns of holes along the sides are connected vertically.

This makes it much easier to distribute power & ground to all those components in the middle.

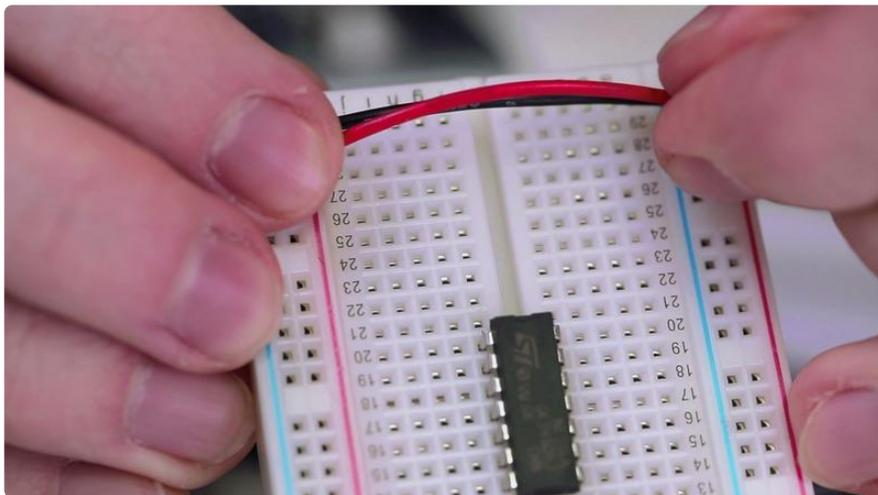

Keep in mind that each outer column is separated from one another - In fact, they can be removed entirely.

If we decide we also want power on the other side, we'll need to use wires to "jump" those connections from one side to the other.

In fact, we use jumper wires whenever we need to connect the breadboard's internal conductors.



You can buy premade jumper wires like these.

But it's easy to make your own, using 22 gauge solid core wire



Just estimate the length you'll need, adding a bit of extra space for the tips.

Clip, then strip the tips.

& commence jumping.



... but avoid using stranded wire, it doesn't work out so well.

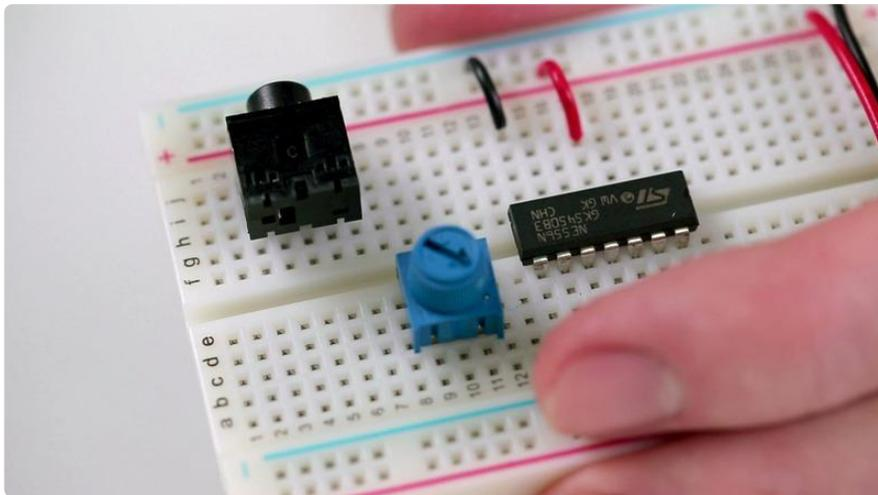

You can find a lot of components that are “breadboard friendly”, meaning that their lead-spacing matches up nicely with a breadboard, so they pop right into place.



Breadboards are great for experimenting, and testing a circuit - but once you're happy with how it works, you'll probably want to make it a bit more permanent.

In that case you can transfer your circuit to a perfboard.

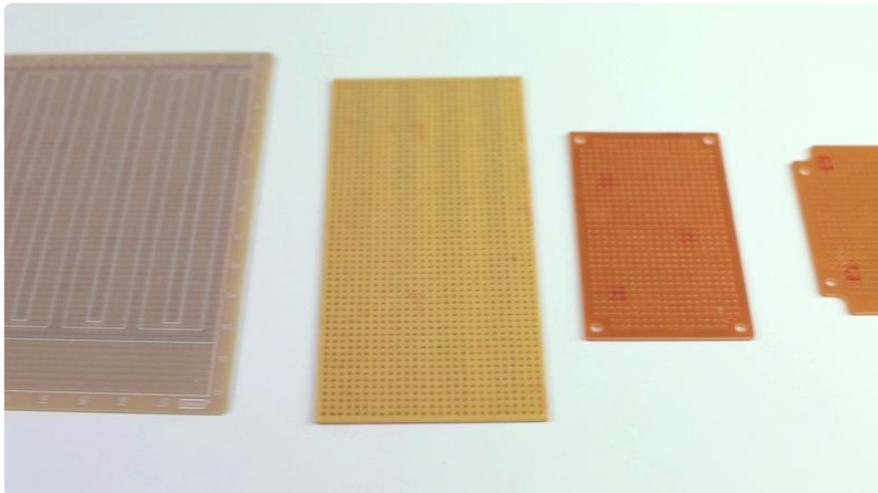

There are many different types available, but at the most basic level, perfboard is a perforated board - providing a grid of holes usually surrounded by metal “pads” which you can securely solder components to.

Most perfboard has the same hole spacing as breadboards - which is convenient.

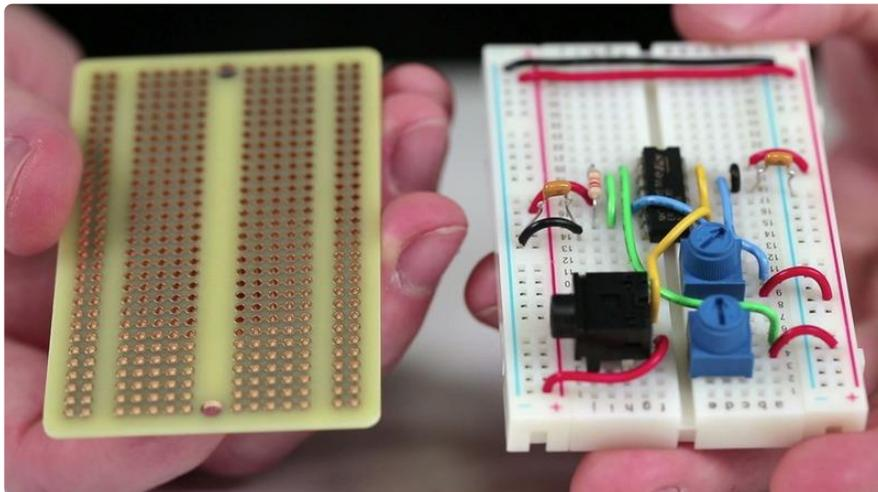

And to make transferring our circuit even easier...

...we can use a permaboard which has its pads preconnected in the same configuration as our breadboard.

So all of our components can be placed the same way as before.

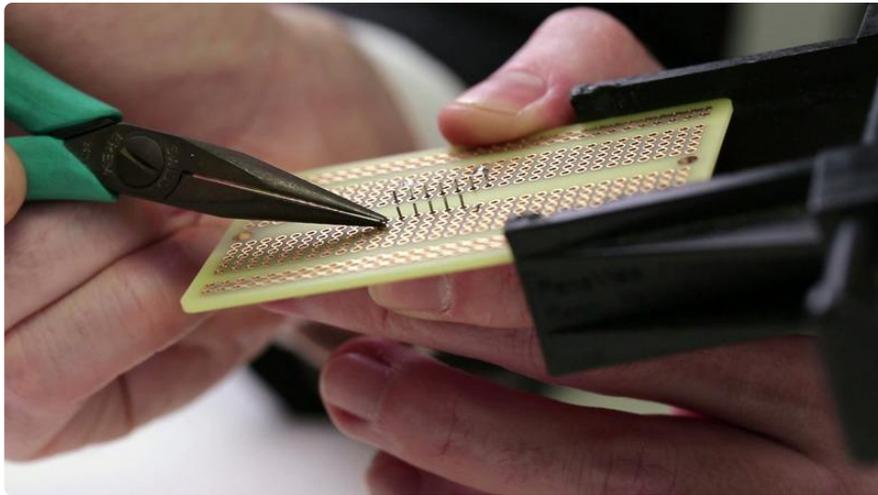

After placing a component on the board, bend its leads outward to keep it in place while soldering.

IC pins are much shorter - but the same technique works for them as well. Just bend each of the corner pins outwards - no need to bend them all.

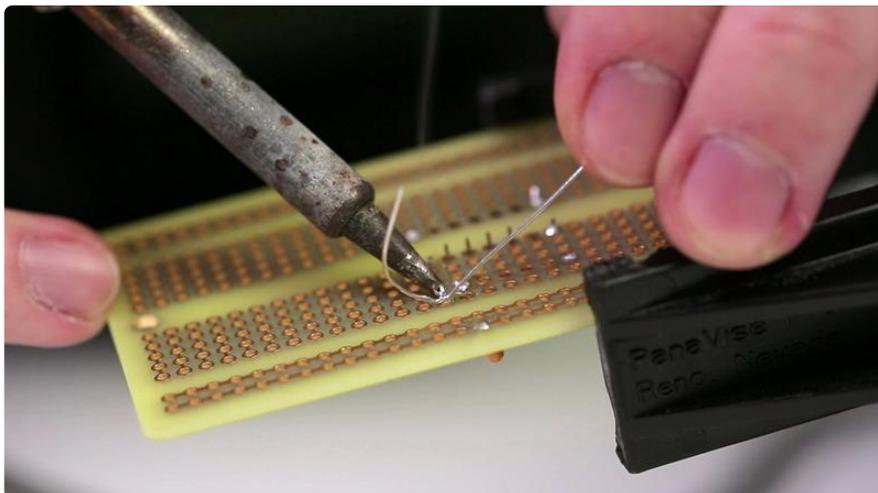

Because perfboard gives us access to the bottom side of our circuit, we can use the long component leads themselves to make some of the connections which required jumpers before.

Just bend the lead over ...

Solder its end to wherever it needs to connect.



Collin: Voila - our circuit now happily resides on sturdy soldered perfboard, and our breadboard is free to do ... other things.

Ladyada: So what were you building anyway?

Collin: Oh, it's an atari punk console.

Ladyada: Oh - cute.



Collin: I suppose the next step would be to make our own printed circuit board ...

... but REALLY ... THAT'S A WHOLE OTHER VIDEO.

Learn More

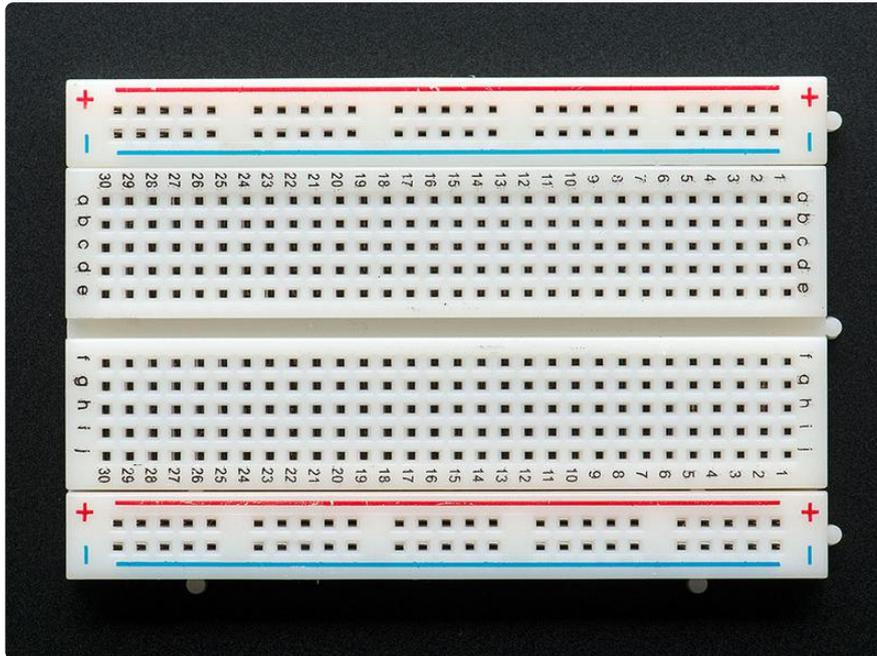

Breadboard

[from Wikipedia \(\)](#)

A breadboard (or protoboard) is usually a construction base for prototyping of electronics. The term "breadboard" is commonly used to refer to a solderless breadboard (plugboard). A breadboard originally was a flat wooden cutting board used to support a loaf of bread (or other foods) while it was being sliced; this original meaning is still in use, but has a new additional meaning as "a base for prototyping". The concept of "breadboarding" as prototyping is not confined to electronic design; "mechanical breadboards" have been and continue to be used by mechanical engineers. Because the solderless breadboard for electronics does not require soldering, it is reusable. This makes it easy to use for creating temporary prototypes and experimenting with circuit design. Older breadboard types did not have this property. A stripboard (veroboard) and similar prototyping printed circuit boards, which are used to build semi-permanent soldered prototypes or one-offs, cannot easily be reused. A variety of electronic systems may be prototyped by using breadboards, from small analog and digital circuits to complete central processing units (CPUs).

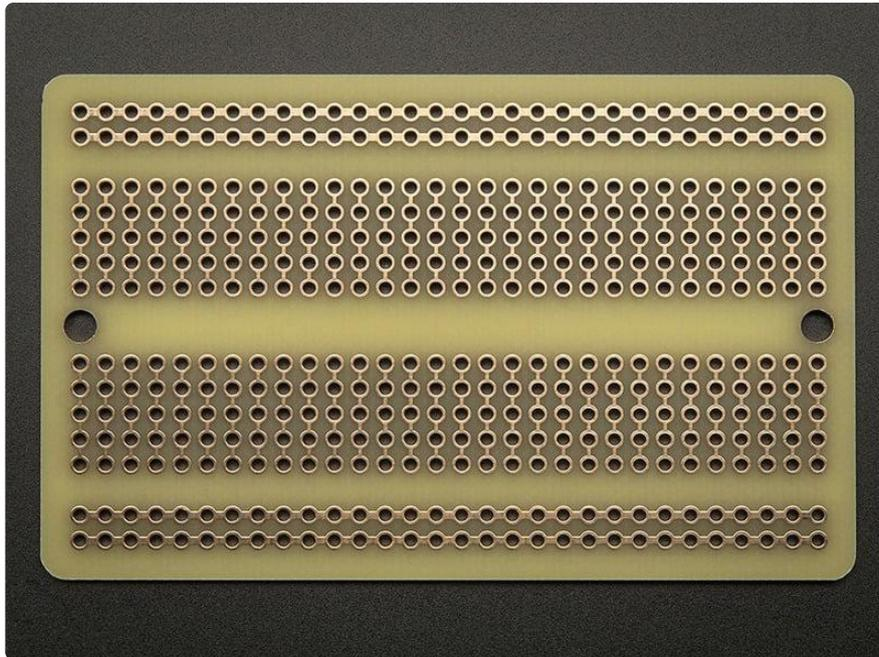

Perfboard

[from Wikipedia \(\)](#)

Perfboard is a material for prototyping electronic circuits also called (DOT PCB). It is a thin, rigid sheet with holes pre-drilled at standard intervals across a grid, usually a square grid of 2.54 mm (0.1 in) spacing. These holes are ringed by round or square copper pads. Inexpensive perfboard may have pads on only one side of the board, while better quality perfboard can have pads on both sides (plate-through holes). Since each pad is electrically isolated, the builder makes all connections with either wire wrap or miniature point to point wiring techniques. Discrete components are soldered to the prototype board such as resistors, capacitors, and integrated circuits. The substrate is typically made of paper laminated with phenolic resin (such as FR-2) or a fiberglass-reinforced epoxy laminate (FR-4).

The 0.1 in grid system accommodates integrated circuits in DIP packages and many other types of through-hole components. Perfboard is not designed for prototyping surface mount devices.