

CAGE DETAILS

(APPLIES TO ALL CAGES IN THIS DRAWING)

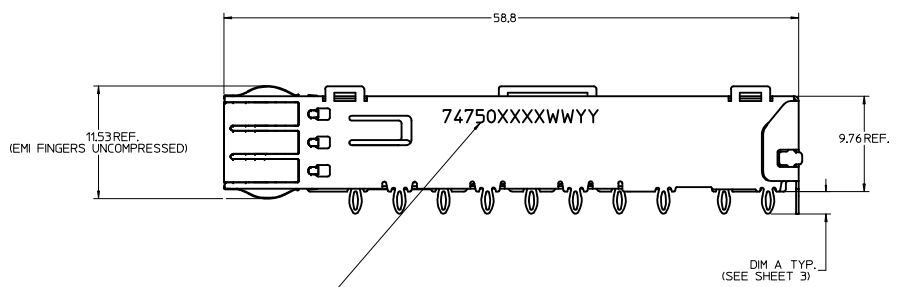
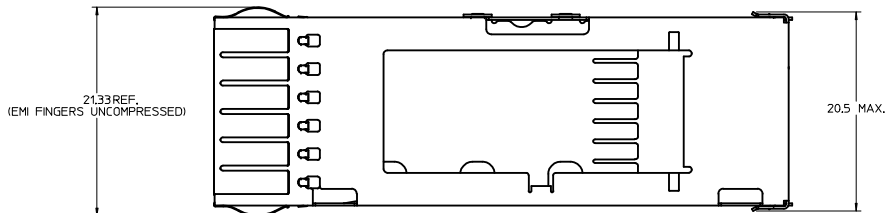

PART NO. AND WEEK/YEAR DATE CODE TO BE PRINTED ON SIDE OF COMPLETED CAGE ASSEMBLY AS SHOWN.

WEEK/YEAR DATE CODE TABLE	
WW	01 THRU 52 EXAMPLE: 01 = FIRST WEEK OF YEAR 52 = LAST WEEK OF YEAR
YY	11, 12, 13 ETC. EXAMPLE: YEAR 2013 = 13

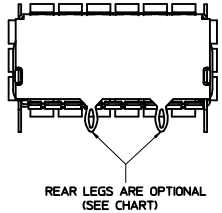
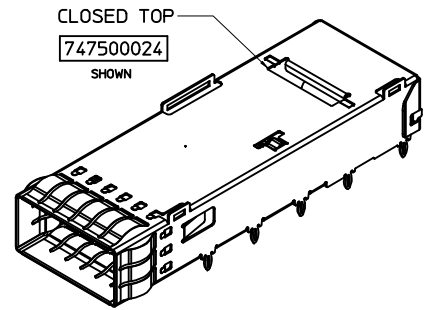
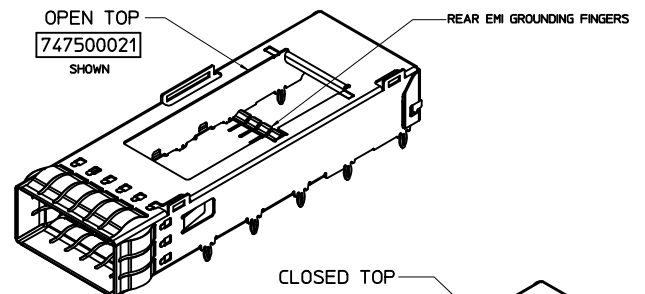
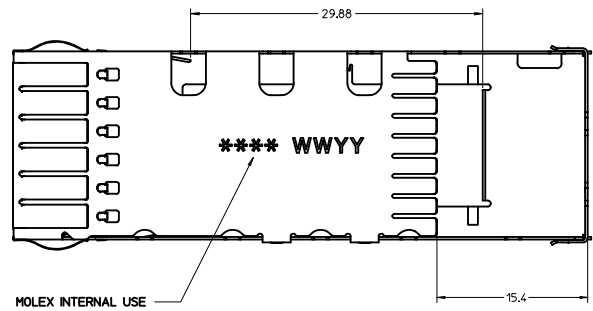

NOTES:

- PRESS FIT LEGS 2.28 / 3.05 mm LONG
- SOLDER POST LEGS 1.90 / 2.90 mm LONG
- SINGLE SIDED BOARD THICKNESS
NOMINAL: 1.60
MINIMUM: 1.44
BELLY TO BELLY BOARD THICKNESS
NOMINAL: 2.30
MINIMUM: 2.07
- MATERIAL: COPPER ALLOY (PLATED PRIOR TO CUTTING AND FORMING)
CAGE: 0.25 mm THICK COPPER ALLOY, NICKEL PLATED OR TIN
SPRING FINGER: 0.08 mm THICK COPPER ALLOY, NICKEL PLATED
HEAT SINK CLIP: STAINLESS STEEL
LIGHT PIPES: POLYCARBONATE (UL 94-V0 RATED)
HEATSINKS: ANNOXIDIZED ALUMINUM
- REFERENCE DOCUMENTS: PRODUCT SPECIFICATION: QSFP MSA
- CUSTOM HEATSHINKS AVAILABLE UPON REQUEST
- QSFP+ ASSEMBLES ALSO AVAILABLE IN 1X2 (74767 SERIES), 1X3 (74768 SERIES), 1X4 (74769 SERIES) AND 1X6 (74771 SERIES).
- PACKAGED IN TRAY.
- NO RoHS EXEMPTIONS.

SEE REVISION SHEET EC NO: CPG2015-1999 DRAWN: ERWIN 2014/10/13 CHECKED: GARDIELLA 2014/10/13 APPROVED: BREED 2014/10/17 REV DESCRIPTION	QUALITY SYMBOLS ∇=0 ∇=0 ∇=0		GENERAL TOLERANCES (UNLESS SPECIFIED) mm INCH 4 PLACES ± --- ± --- 3 PLACES ± --- ± --- 2 PLACES ± 0.13 ± --- 1 PLACE ± 0.25 ± --- 0 PLACE ± --- ± --- ANGULAR ± 1 ° DRAFT WHERE APPLICABLE MUST REMAIN WITHIN DIMENSIONS		DIMENSION STYLE MM ONLY DRAWN BY DATE CHIRSCHY 2007/07/23 CHECKED BY DATE BRUSSELL 2007/07/23 APPROVED BY DATE RMAHOOD 2010/11/01 MATERIAL NO. SEE SHEET 3 DOCUMENT NO. SD-74750-0021		SCALE 4:1 DESIGN UNITS METRIC THIRD ANGLE PROJECTION TITLE QSFP+ CAGE ASSEMBLY WITH SPRING FINGERS SHEET NO. 1 OF 8	
					molex			
					THIS DRAWING CONTAINS INFORMATION THAT IS PROPRIETARY TO MOLEX INCORPORATED AND SHOULD NOT BE USED WITHOUT WRITTEN PERMISSION			

CAGE ASSEMBLY OPTIONS

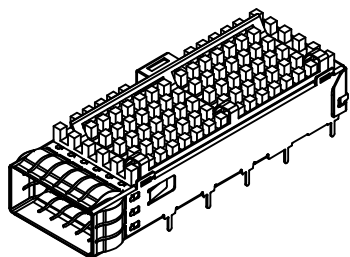
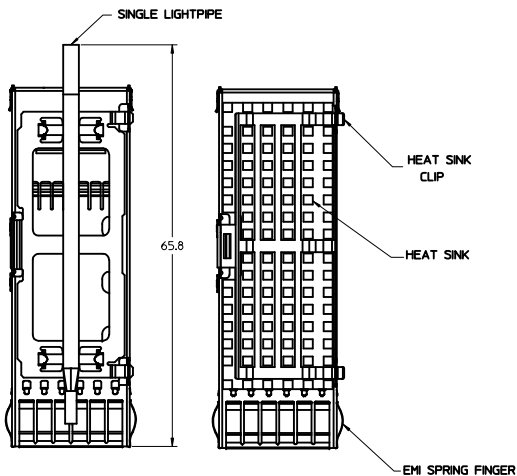

HEATSHINK AND LIGHT PIPE OPTIONS

HEAT SINK ONLY

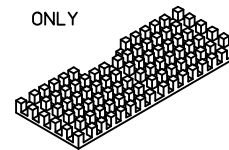

SINGLE LIGHT PIPE

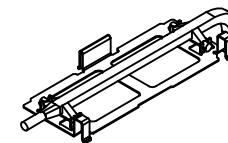

MOLEX P/N: 747500030

DUAL LIGHT PIPE

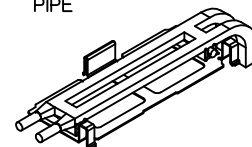

MOLEX P/N: 747500031

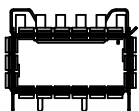

LEG TYPE OPTIONS

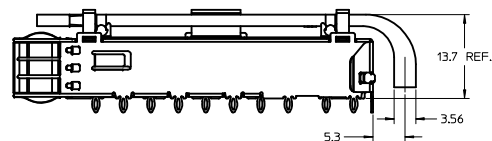
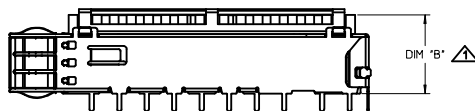
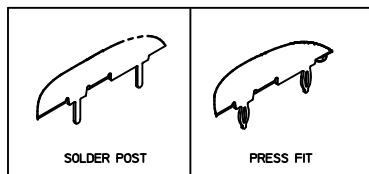

HEATSINK HEIGHT OPTIONS

OVERALL HEATSINK HEIGHT	DIM B	TOL
PCI	13.7	+0.25
SAN	16.0	-0.73
NET	23.0	

▲ HEIGHT OF HEATSINK WITH MODULE INSERTED.
DIMENSION MAY BE LESS DUE TO MODULE AND HEATSINK VARIATIONS.

REAR LEG OPTIONS

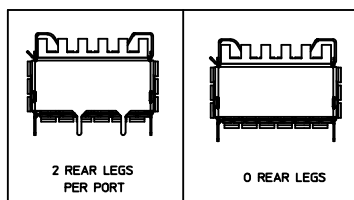

REV	DESCRIPTION	QUALITY SYMBOLS	GENERAL TOLERANCES (UNLESS SPECIFIED)		DIMENSION STYLE	SCALE	DESIGN UNITS	THIRD ANGLE PROJECTION
			mm	INCH				
4	PLACES ± 0.13	▽=0	± 0.13	± 0.005	MM ONLY	2.5:1	METRIC	TITLE QSFP+ CAGE ASSEMBLY WITH SPRING FINGERS molex DOCUMENT NO. SD-74750-0021 SHEET NO. 2 OF 8
3	PLACES ± 0.25	▽=0	± 0.25	± 0.010				
2	PLACES ± 0.25	▽=0	± 0.25	± 0.010				
1	PLACE ± 0.25	▽=0	± 0.25	± 0.010				
0	PLACE ± 0.25	▽=0	± 0.25	± 0.010				
SEE REVISION SHEET EEC NO: CPG2015-1999 DRAWN: ERWIN 2014/10/13 CHKD: GABRIELLA 2014/10/13 APPROVED: BREED 2014/10/17			ANGLAR ± 1 ° DRAFT WHERE APPLICABLE MUST REMAIN WITHIN DIMENSIONS		DRAWN BY: CHIRSCHY DATE: 2007/07/23 CHECKED BY: BRUSSELL DATE: 2007/07/23 APPROVED BY: RMAHMOOD DATE: 2010/11/01		MATERIAL NO. SEE SHEET 3 SIZE: D	

PART NUMBER SELECTION

NO HEATSINKS
NO LIGHT PIPES

747500024
SHOWN

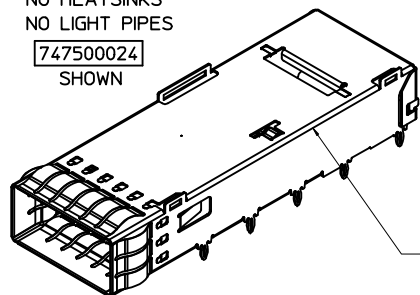

CLOSED TOP

NO HEATSINKS
NO LIGHT PIPES

747500021
SHOWN

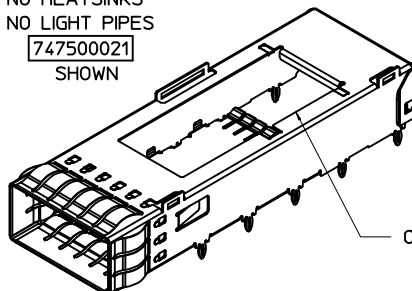

OPEN TOP

WITH HEATSINKS
NO LIGHT PIPES

747500057
SHOWN

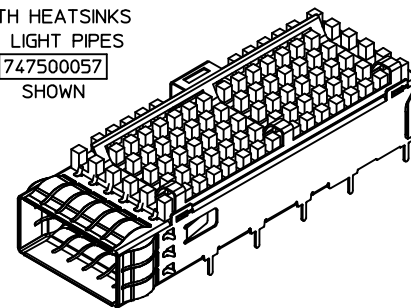

MOLEX P/N		# OF REAR LEGS PER PORT	DIM A	PLATING
LEG TYPE PRESS FIT	LEG TYPE SOLDER POST			
747500024	---	2	2.28	NICKEL
---	747500051	2	1.9	NICKEL
---	747500053	2	1.9	MATTE TIN
---	747500056	2	1.9	BRIGHT TIN

MOLEX P/N		# OF REAR LEGS PER PORT	DIM A	PLATING
LEG TYPE PRESS FIT	LEG TYPE SOLDER POST			
747500012	---	2	3.05	NICKEL
747500021	---	2	2.28	NICKEL
747500023	---	0	2.28	NICKEL
---	747500058	2	2.90	NICKEL
---	747500062 *	2	2.90	NICKEL

MOLEX P/N		# OF REAR LEGS PER PORT	DIM A	DIM B	PLATING
LEG TYPE PRESS FIT	LEG TYPE SOLDER POST				
---	747500057	2	2.9	13.7	NICKEL
747500040	---	2	2.28	16.0	NICKEL
747500042	---	0	2.28	16.0	NICKEL
747500044	---	2	2.28	13.7	NICKEL
747500046	---	2	2.28	23.0	NICKEL

NO HEATSINKS
WITH LIGHT PIPES

747501586
SHOWN

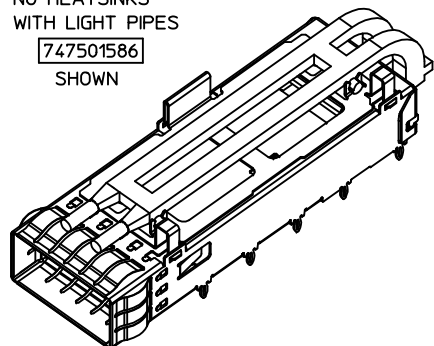

MOLEX ASSEMBLY P/N	MOLEX P/N		LIGHT PIPE ASSEMBLY P/N	#OF REAR LEGS PER PORT	DIM A	PLATING
	LEG TYPE PRESS FIT	LEG TYPE SOLDER POST				
747501586	747500024	---	747500031	2	2.28	NICKEL

* HEATSINK/LIGHT PIPE CLIP FEATURE REMOVED.

SEE REVISION SHEET IEC NO. CPG2015-1999 DRAWN: LERMIN 2014/10/13 CHECKED: GARDELLA 2014/10/13 APPR: BREED 2014/10/17 REV: DESCRIPTION	QUALITY SYMBOLS	GENERAL TOLERANCES (UNLESS SPECIFIED)	DIMENSION STYLE	SCALE	DESIGN UNITS	THIRD ANGLE PROJECTION	
	▽=0	4 PLACES ± mm ± INCH	MM ONLY	3:1	METRIC	☉	
	▽=0	3 PLACES ± 0.13 ± ---	DRAWN BY DATE	CHIRSCHY 2007/07/23	TITLE		
	▽=0	2 PLACES ± 0.25 ± ---	CHECKED BY DATE	BRUSSELL 2007/07/23	QSFP+ CAGE ASSEMBLY WITH SPRING FINGERS		
		1 PLACE ± --- ± ---	APPROVED BY DATE	RMAMMOOD 2010/11/01			
		0 PLACE ± --- ± ---	MATERIAL NO.	SEE SHEET 3	DOCUMENT NO.	SD-74750-0021	
		ANGULAR ± 1°	SHEET NO. 3 OF 8				
		DRAFT WHERE APPLICABLE MUST REMAIN WITHIN DIMENSIONS	THIS DRAWING CONTAINS INFORMATION THAT IS PROPRIETARY TO MOLEX INCORPORATED AND SHOULD NOT BE USED WITHOUT WRITTEN PERMISSION				

PCB LAYOUT FOR SINGLE SIDED APPLICATIONS

FOR CAGE ASSEMBLIES WITH LIGHT PIPES

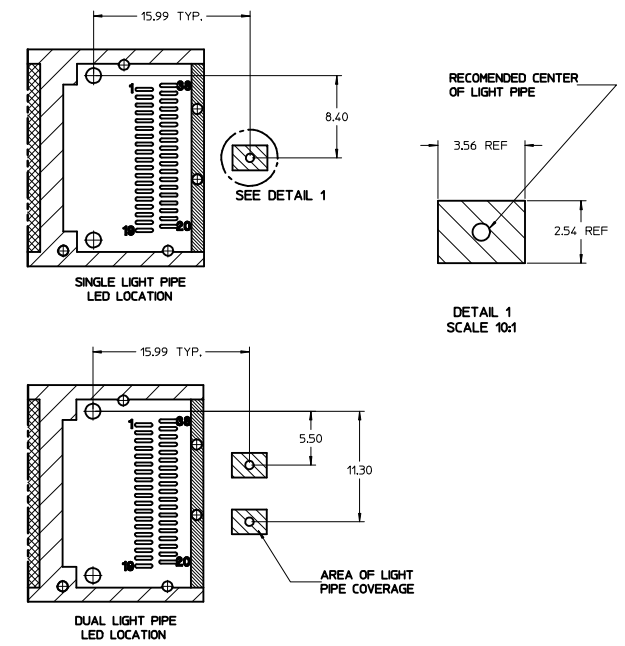
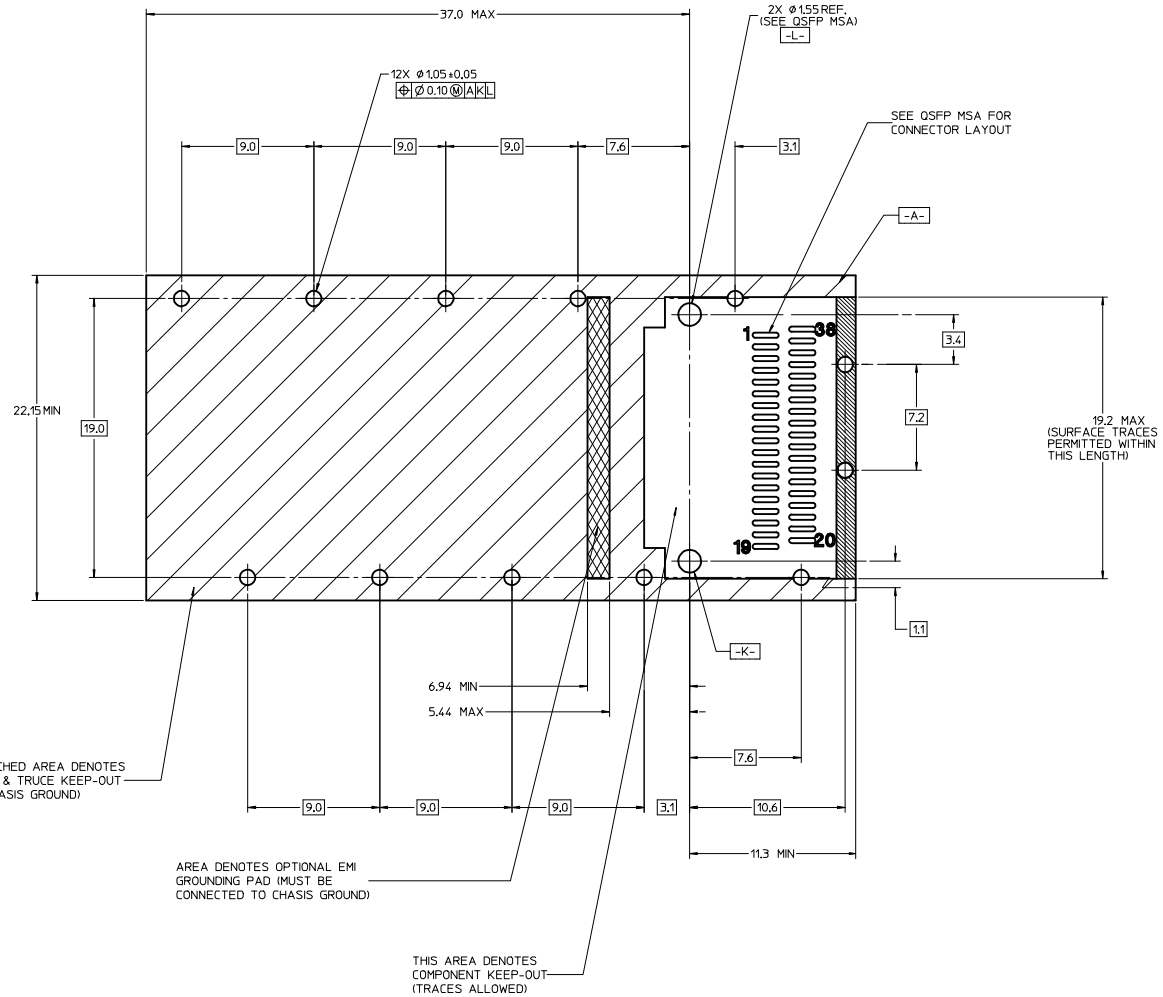

NOTES:

1. DATUM -A- IS TOP SURFACE OF HOST BOARD PER MSA
2. FINISHED HOLE SIZE (AFTER PLATING)
3. DATUM -K- IS HOST BOARD THRU HOLE #1 TO ACCEPT CONNECTOR GUIDE POST PER MSA
4. DATUM -L- IS HOST BOARD THRU HOLE #2 TO ACCEPT CONNECTOR GUIDE POST PER MSA

SEE REVISION SHEET EC NO: CPG2015-1999 DRAWN BY: LERMIN 2014/10/13 CHYKOBARDILLA 2014/10/13 APPROVED BY: BREED 2014/10/17	QUALITY SYMBOLS ∇=0 ∇=0 ∇=0		GENERAL TOLERANCES (UNLESS SPECIFIED) mm INCH 4 PLACES ±--- ±--- 3 PLACES ±--- ±--- 2 PLACES ±0.13 ±--- 1 PLACE ±0.25 ±--- 0 PLACE ±--- ±---		DIMENSION STYLE MM ONLY		SCALE 1:1		DESIGN UNITS METRIC		THIRD ANGLE PROJECTION	
	DRAWN BY: CHIRSCHY DATE: 2007/07/23 CHECKED BY: BRUSSELL DATE: 2007/07/23 APPROVED BY: MAHMOOD DATE: 2010/11/01		ANGULAR ± 1 ° DRAFT WHERE APPLICABLE MUST REMAIN WITHIN DIMENSIONS		MATERIAL NO.		DOCUMENT NO.		TITLE QSFP+ CAGE ASSEMBLY WITH SPRING FINGERS		SHEET NO. 4 OF 8	
	SEE SHEET 3		THIS DRAWING CONTAINS INFORMATION THAT IS PROPRIETARY TO MOLEX INCORPORATED AND SHOULD NOT BE USED WITHOUT WRITTEN PERMISSION		SD-74750-0021		molex		INCORPORATED AND SHOULD NOT BE USED WITHOUT WRITTEN PERMISSION		SHEET NO. 4 OF 8	
	SIZE D		THIS DRAWING CONTAINS INFORMATION THAT IS PROPRIETARY TO MOLEX INCORPORATED AND SHOULD NOT BE USED WITHOUT WRITTEN PERMISSION		SD-74750-0021		molex		INCORPORATED AND SHOULD NOT BE USED WITHOUT WRITTEN PERMISSION		SHEET NO. 4 OF 8	

PCB LAYOUT FOR BELLY-TO-BELLY APPLICATIONS

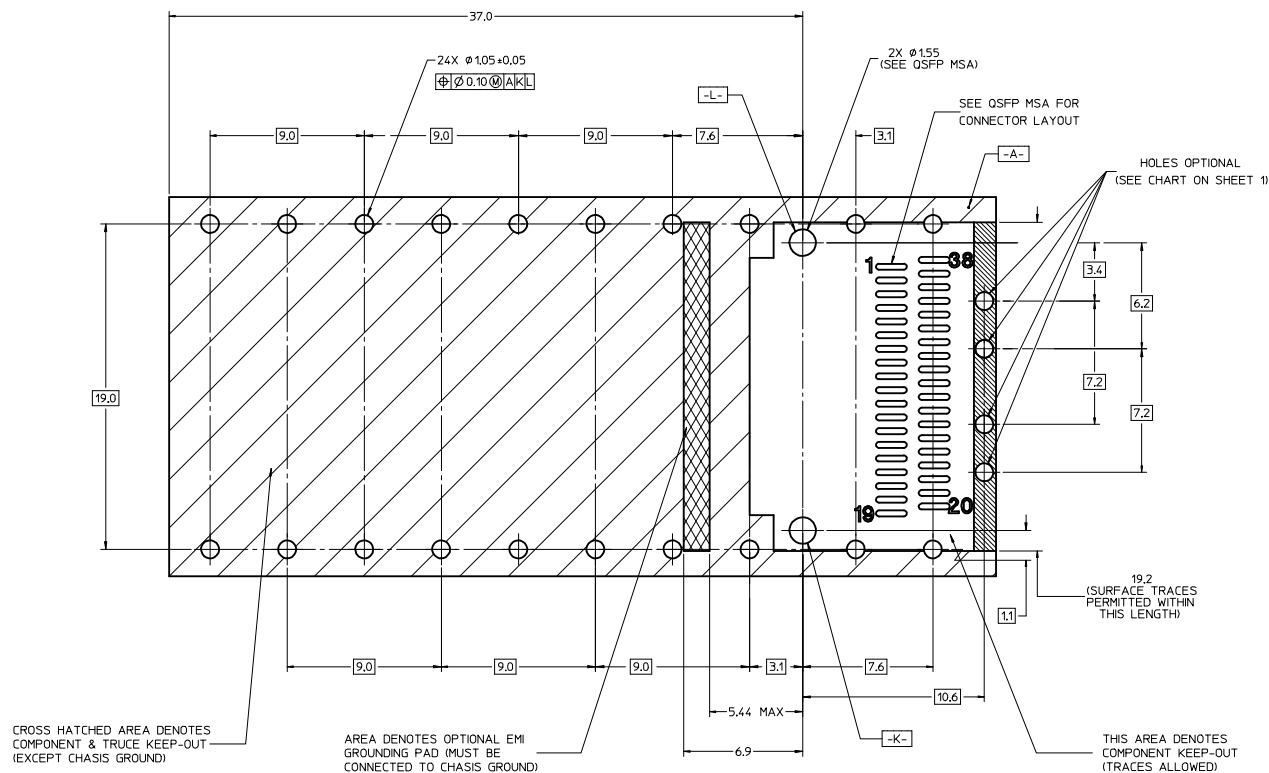

NOTE:
FOR RECOMENDED CENTER
OF LIGHT PIPES,
SEE SHEET 4

NOTES:

1. DATUM -A- IS TOP SURFACE OF HOST BOARD PER MSA.
2. FINISHED HOLE SIZE (AFTER PLATING).
3. DATUM -K- IS HOST BOARD THRU HOLE #1 TO ACCEPT CONNECTOR GUIDE POST PER MSA.
4. DATUM -L- IS HOST BOARD THRU HOLE #2 TO ACCEPT CONNECTOR GUIDE POST PER MSA.

SEE REVISION SHEET EEC NO: CPG2015-1999 DRAWN BY: ERWIN CHKD BY: GABRIELLA APPR: BREED DATE: 2014/10/13 DATE: 2014/10/13 DATE: 2014/10/17	QUALITY SYMBOLS ∇=0 ∇=0 ∇=0	GENERAL TOLERANCES (UNLESS SPECIFIED)		DIMENSION STYLE MM ONLY	SCALE 1:1	DESIGN UNITS METRIC	THIRD ANGLE PROJECTION		
		4 PLACES ± 0.13	3 PLACES ± 0.25	2 PLACES ± 0.13	1 PLACE ± 0.25	0 PLACE ± 0.25	DRAWN BY: CHIRSCHY DATE: 2007/07/23 CHECKED BY: BRUSSELL DATE: 2007/07/23 APPROVED BY: RMAHMOOD DATE: 2010/11/01		
		ANGULAR ± 1 °							
		DRAFT WHERE APPLICABLE MUST REMAIN WITHIN DIMENSIONS					MATERIAL NO. SEE SHEET 3		
					DOCUMENT NO. SD-74750-0021		SHEET NO. 5 OF 8		

BEZEL AND BOARD POSITION DIMENSIONS
FOR SINGLE SIDE MOUNTING

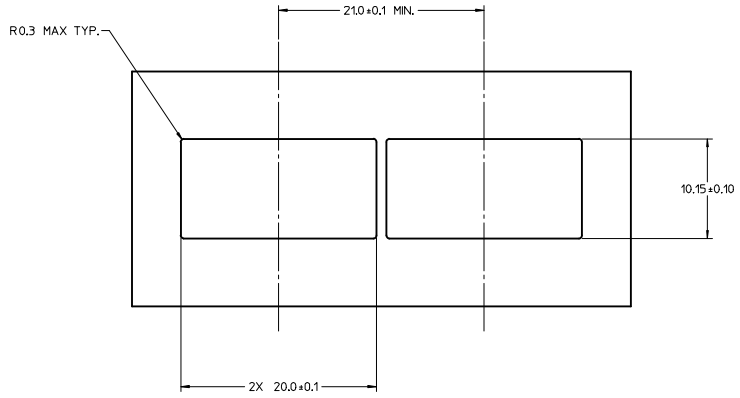

BEZEL AND BOARD POSITION DIMENSIONS
FOR BELLY-TO-BELLY MOUNTING

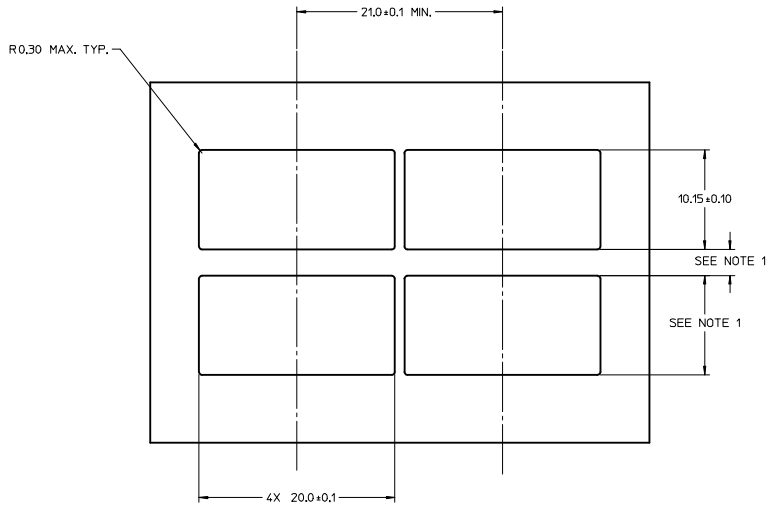

NOTE:
1. SEE QSFP MSA SPECIFICATION FOR BEZEL LOCATION TOLERANCE.
2. PCB THICKNESS VARIATION MUST BE CONSIDERED WHEN DETERMINING BEZEL OPENING, SIZE, AND LOCATION.

SEE REVISION SHEET IEC NO. CPG2015-1999 DRAWN BY: ERMIN 2014/10/13 CHECKED BY: GARDELLA 2014/10/13 APPR: BREED 2014/10/17	QUALITY SYMBOLS	GENERAL TOLERANCES (UNLESS SPECIFIED)	DIMENSION STYLE	SCALE	DESIGN UNITS	THIRD ANGLE PROJECTION
	▽=0	mm INCH	MM ONLY	1:1	METRIC	☉
	▽=0	4 PLACES ± --- ± ---	DRAWN BY: CHIRSCHY	DATE: 2007/07/23	TITLE: QSFP+ CAGE ASSEMBLY WITH SPRING FINGERS	
	▽=0	3 PLACES ± 0.13 ± ---	CHECKED BY: BRUSSELL	DATE: 2007/07/23	DOCUMENT NO. SD-74750-0021	
	ANGULAR ± 1°	DRAFT WHERE APPLICABLE MUST REMAIN WITHIN DIMENSIONS	MATERIAL NO.	DATE: 2010/11/01	SHEET NO. 6 OF 8	
			SEE SHEET 3	THIS DRAWING CONTAINS INFORMATION THAT IS PROPRIETARY TO MOLEX INCORPORATED AND SHOULD NOT BE USED WITHOUT WRITTEN PERMISSION		

BEZEL LIGHT PIPE CUTOUT POSITION DIMENSIONS FOR SINGLE SIDE MOUNTING

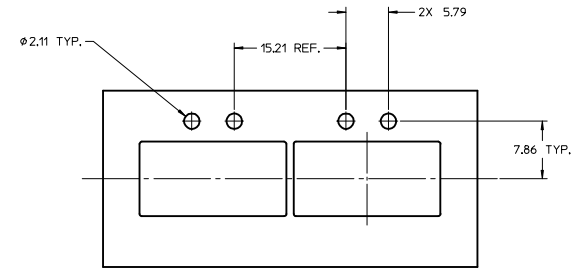
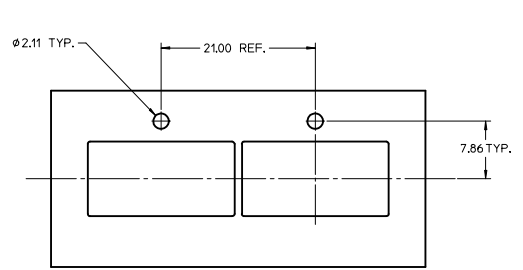

BEZEL LIGHT PIPE CUTOUT POSITION DIMENSIONS FOR BELLY-TO-BELLY MOUNTING

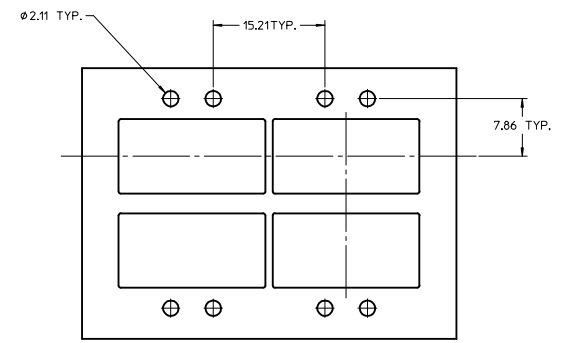
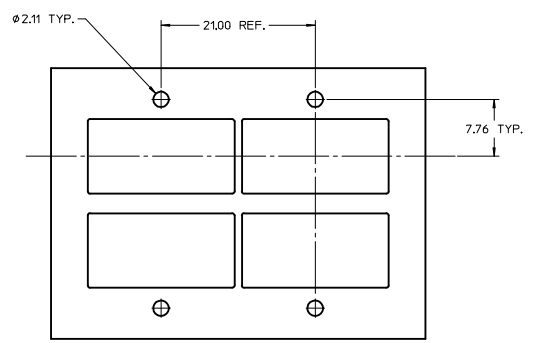

SEE REVISION SHEET IEC NO. CPG2015-1999 DRAWN: LERMIN 2014/10/13 CHECKED: GARDELLA 2014/10/13 APPR: BREED 2014/10/17	QUALITY SYMBOLS ∇=0 ∇=0 ∇=0	GENERAL TOLERANCES (UNLESS SPECIFIED)		DIMENSION STYLE	SCALE	DESIGN UNITS	THIRD ANGLE PROJECTION		
				MM ONLY	3:1	METRIC			
				ANGULAR ± 1°	DRAWN BY DATE		TITLE QSFP+ CAGE ASSEMBLY WITH SPRING FINGERS		
				DRAFT WHERE APPLICABLE MUST REMAIN WITHIN DIMENSIONS	CHIRSCHY 2007/07/23 CHECKED BY DATE BRUSSELL 2007/07/23 APPROVED BY DATE RMAHMOOD 2010/11/01				
				MATERIAL NO.		DOCUMENT NO.			
				SEE SHEET 3		SD-74750-0021			
				SIZE		SHEET NO.			
				D THIS DRAWING CONTAINS INFORMATION THAT IS PROPRIETARY TO MOLEX INCORPORATED AND SHOULD NOT BE USED WITHOUT WRITTEN PERMISSION		7 OF 8			

DATE	REV	DESCRIPTION
2007/07/23	A	INITAL RELEASE
2007/08/06	B	CHANGED ALL TANGENT LINES FROM DASHED LINES TO SOLID LINES
2007/08/10	C	1. ADDED COMPONENT P/N COLUMN TO TABLE 2. ADDED 'COMPONENT' TO NOTE IN BOTTOM VIEW ON SHEET 1 3. CHANGED TEXT IN MATERIAL NO. SECTION OF TITLE BLOCK TO READ 'SEE TABLE'
2008/07/10	D	1. REMOVED COMMENTS FROM TABLE ON SHEET 1 2. ADDED 'HOLES OPTIONAL' NOTE TO PCB LAYOUT ON SHEET 2 AND SHEET 3 3. ADDED 747500024 TO TABLE ON SHEET 1 AS WELL AS ISO VIEW 4. UPDATED 'COMPONENT PART NUMBER AND DATE CODE' NOTE ON SHEET 1
2008/12/16	E	1. 20.4 DIMENSION WAS 20.38 REF. 2. 58.8 DIMENSION WAS 58.80 REF. 3. 2.28 TYP. DIMENSION WAS 2.28 REF. 4. 15.4 DIMENSION WAS 15.40 REF.
2009/04/13	F	1. REVISED COMPONENT P/N FOR MOLEX P/N 747500024 (CHANGED FROM 747540104 TO 747500104)
2010/10/29	G	1. 20.5 MAX DIMENSION WAS 20.4 2. 19.2 MAX DIMENSION WAS 16.2 MAX
2011/04/05	H	1. ADDED PRINTED DATE CODE TO LEFT SIDE OF CAGE AND ASSOCIATED NOTES. 2. ADDED CUTAWAY 1 AND CRITICAL TO FUNCTION DIMENSION 29.88 ±0.15, SHEET 1. 3. REMOVED 74750 FROM BOTTOM OF CAGE, SHEET 1. 4. UPDATED RoHS NOTE (NOTE 5) TO 'LEAD FREE, NO RoHS EXEMPTIONS' ON SHEET 1. 5. ADDED END VIEW, SHEET 1.
2012/04/13	I	1. ADDED 747500012 TO P/N TABLE, SHEET 1. 2. UPDATED BELLY-TO-BELLY CAGE VIEW, SHEET 3. 3. ADDED BELLY-TO-BELLY BEZEL AND DIMENSIONS, SHEET 3.
2013/01/10	J	1. ADDED 747500057 AND 747500058 INTO P/N TABLE, SHEET 3. 2. REARRANGE EACH SHEET
2013/04/09	K	1. ADDED P/N 747500062 TO CHART ON PAGE 3. 2. UPDATED DIMENSION 9.77 TO 9.76 BY CORRECTING PLACEMENT ON VIEWS SHEET 6.
2014/10/13	L	1. ADDED P/N 747501586 AND ISO VIEW TO SHEET 3.

SEE REVISION SHEET EEC NO: CPG2015-1999 DRAWN: ERWIN 2014/10/13 CHKD: GABRIELLA 2014/10/13 APPR: BREED 2014/10/17 REV:	QUALITY SYMBOLS ∇=0 ∇=0 ∇=0	GENERAL TOLERANCES (UNLESS SPECIFIED): mm INCH 4 PLACES ±--- ±--- 3 PLACES ±--- ±--- 2 PLACES ±0.13 ±--- 1 PLACE ±0.25 ±--- 0 PLACE ±--- ±---	DIMENSION STYLE MM ONLY	SCALE 1:1	DESIGN UNITS METRIC	THIRD ANGLE PROJECTION 	
		DRAWN BY DATE CHIRSCHY 2007/07/23	CHECKED BY DATE BRUSSELL 2007/07/23	APPROVED BY DATE RMAHMOOD 2010/11/01	MATERIAL NO. SEE SHEET 3	DOCUMENT NO. SD-74750-0021	SHEET NO. 8 OF 8
		ANGULAR ± 1 ° DRAFT WHERE APPLICABLE MUST REMAIN WITHIN DIMENSIONS					
		THIS DRAWING CONTAINS INFORMATION THAT IS PROPRIETARY TO MOLEX INCORPORATED AND SHOULD NOT BE USED WITHOUT WRITTEN PERMISSION					