

THESE DRAWINGS ARE THE PROPERTY OF QUALTEK ELECTRONICS AND NOT TO BE REPRODUCED FOR OR COMMUNICATED TO A THIRD PARTY WITHOUT THE EXPRESS WRITTEN PERMISSION OF AN OFFICER OF QUALTEK ELECTRONICS.

REVISION			
REV.	DESCRIPTION	DATE	APPROVED

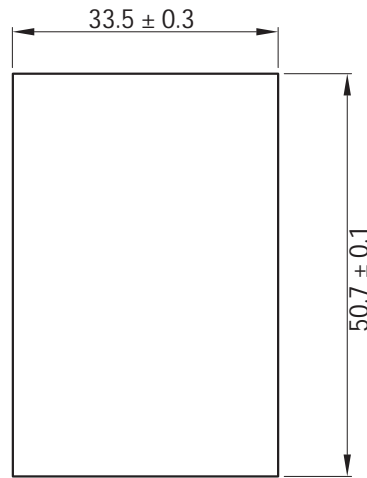
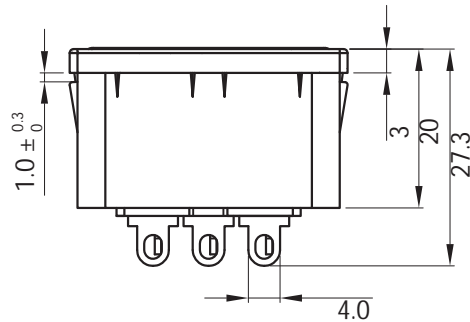
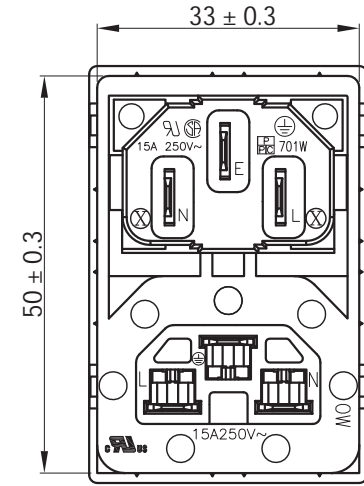
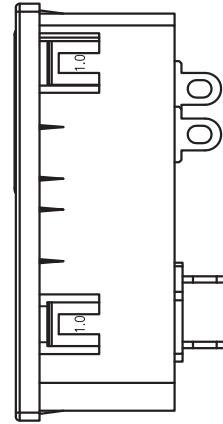
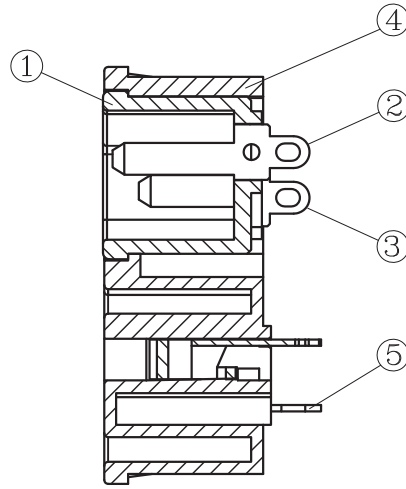
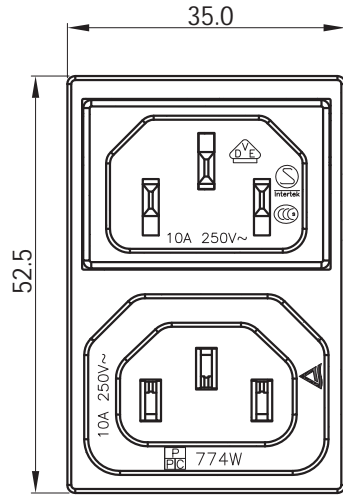

PANEL CUTOUT

NOTES:

701W IEC 60320 C14
 RATING:
 UL, CSA: 15A 250V AC
 VDE, CCC: 10A 250V AC
 774W IEC 60320 C13
 RATING:
 UL, cUL: 15A 250V AC
 VDE: 10A 250V AC
 PANEL THICKNESS: 1.0mm
 RoHS COMPLIANT

CONTROLLED

5	Contact PIN t=0.8mm Tin-Plated	3
4	Body Insulator PC Black Color	1
3	Contact PIN Brass Strip t=2mm Tin-Plated	2
2	Contact PIN Brass Strip t=2mm Tin-Plated	1
1	Body Insulator PC Black Color	1

Dim range (mm)	Tolerance +/- (mm)	Qualtek Electronics Corp. PPC DIVISION		
		Part Number: 774W-10/01	RoHS Compliant	
0-1	0.40	Description: AC RECEPTACLE		
1-6	0.45			
6-18	0.50			
18-50	0.50			
50-120	0.70			
120-250	0.90	UNIT: mm		
250-500	1.20	Drawn / Date	Checked / Date	Approved / Date
		R. Nuti 08-03-20	08-03-20	LY / 08-03-20