

External MIMO 2xLTE + Wi-Fi + GNSS COMBO ANTENNA



AECW0801C09

Request Samples



Check Inventory



Ø 81.3 x 16.3 mm
RoHS/RoHS II Compliant
MSL Level = 1

Features

- 4 cabled combo antenna
 - 2x MIMO 4G LTE
 - 1x Wi-Fi 2.4/5 GHz
 - 1x Active GNSS/GPS/GLONASS/BeiDou/QZSS
- Global 4G cellular band coverage including CAT M and NB-IoT
- IP67 rated
- Easy installation using Screw
- Fully customizable RF cable and connector options

Applications

- IoT
- M2M
- Smart City
- Telematics
- Transportation
- Smart Agriculture
- Geolocation and Tracking

Product Image



External MIMO 2xLTE + Wi-Fi + GNSS COMBO ANTENNA



AECW0801C09

Request Samples



Check Inventory



Ø 81.3 x 16.3 mm
RoHS/RoHS II Compliant
MSL Level = 1

Part Number Builder

AECW0801C09 -

Color / UV Coating	
Code	Description
S (Standard)	Black without UV coating
A	Black with UV Coating
B	White without UV Coating
C	White with UV Coating

Cable length in 'mm'	
Code	Description
Maximum cable length supported : RG-174 (up to 3000 mm) LMR-100 (up to 5000 mm)	
3000 (Standard)	3000 mm
Other Examples :	
0200	200 mm
2000	2000 mm

Cable Type & Connector Type				
Code	Cable Type	Connector Type		
		LTE	GNSS	Wi-Fi
S (Standard)	RG-174	SMA (M)	SMA (M)	-
	LMR-100	-	-	SMA (M)
A	LMR-100	SMA (M)	SMA (M)	SMA (M)
B	LMR-100	SMA (M)	FAKRA C (F)	SMA (M)
C	LMR-100	FAKRA D (F)	SMA (M)	SMA (M)
D	LMR-100	FAKRA D (F)	FAKRA C (F)	SMA (M)
E	RG-174	SMA (M)	FAKRA C (F)	-
	LMR-100	-	-	SMA (M)
F	RG-174	FAKRA D (F)	SMA (M)	-
	LMR-100	-	-	SMA (M)
G	RG-174	FAKRA D (F)	FAKRA C (F)	-
	LMR-100	-	-	SMA (M)

Example Configurations :

Part Number	UV Protection Coating / Color	Cable length	Cable Type / Connector Type
AECW0801C09 S-3000S	No / Black	3000 mm	2xRG-174 with 2xSMA (M) for LTE + 1xRG-174 with 1xSMA (M) for GNSS + 1xLMR-100 with 1xSMA (M) for Wi-Fi (Standard)
AECW0801C09 A-1000A	Yes / Black	1000 mm	3xLMR-100 with 2xSMA (M) for LTE + 1xSMA (M) for GNSS + 1xSMA (M) for Wi-Fi
AECW0801C09 B-5000G	No / White	5000 mm	2xRG-174 with 2xFAKRA D (F) for LTE + 1xFAKRA C (F) for GNSS + 1xLMR-100 with 1xSMA (M) for Wi-Fi

Note :

- For the standard part number (AECW0801C09**S-3000S**), please refer to the packaging at the end of the document
- For additional configuration (AECW0801C09-), MOQs, pricing and packaging changes may be applicable



5101 Hidden Creek Ln Spicewood TX 78669
Phone: 512-371-6159 | Fax: 512-351-8858
For terms and conditions of sales, please visit:
www.abracon.com

REVISED: 05-08-20

ABRACON IS
ISO9001-2015
CERTIFIED

External MIMO 2xLTE + Wi-Fi + GNSS COMBO ANTENNA



AECW0801C09

Request Samples



Check Inventory



Ø 81.3 x 16.3 mm
RoHS/RoHS II Compliant
 MSL Level = 1

Electrical Specifications

Parameter	Specification			Unit
	Min	Typ	Max	
GNSS Antenna				
Frequency	1561		1602	MHz
Gain			2.0	dBiC
VSWR			1.5	
Impedance		50		Ω
Polarization	RHCP			
Axial Ratio			3.0	dB
LNA				
Noise Figure			1.5	dB
Gain	26	28	30	dB
VSWR			2.0	
Supply Voltage	2.2		5.0	V
Current Consumption			15.0	mA
2xMIMO LTE Antenna – Main & Aux				
Frequency	698		960	MHz
	1710		2690	
VSWR			3.0	
Gain	Main		2.5	dBi
	Aux		2.0	
Impedance		50		Ω
Polarization	Linear			
Wi-Fi Antenna				
Frequency	2400		2483.5	MHz
	4900		5825	
VSWR			2.5	
Gain			3.0	dBi
Impedance		50		Ω
Polarization	Linear			

External MIMO 2xLTE + Wi-Fi + GNSS COMBO ANTENNA



AECW0801C09

Request Samples



Check Inventory



Ø 81.3 x 16.3 mm
RoHS/RoHS II Compliant
MSL Level = 1

Mechanical Specifications

Parameter	Specification
Antenna Dimension	Ø 81.3 x 16.3 mm
Material	ABS
Mounting Type	Screw
RF Connector	4x SMA (M)
RF Cable	3x RG-174 (LTE,GNSS) + 1x LMR-100 (Wi-Fi)
Cable Length	3 m

Environmental Specification

Parameter	Specification
Operating Temperature	-40°C to +85°C
Storage Temperature	-40°C to +85°C
Relative Humidity	Up to 95%
RoHS Compliance	Yes
PB Free	Yes
MSL	1
ESD Sensitive	Yes
Vibration	10 ~ 55 Hz with 1.5 mm amplitude 2 hrs
Ingress Protection	IP67 (excluding cable outlet)
UL rating	UL-94 HB



5101 Hidden Creek Ln Spicewood TX 78669
Phone: 512-371-6159 | Fax: 512-351-8858
For terms and conditions of sales, please visit:
www.abracon.com

REVISED: 05-08-20

ABRACON IS
ISO9001-2015
CERTIFIED

External MIMO 2xLTE + Wi-Fi + GNSS COMBO ANTENNA



AECW0801C09

Request Samples



Check Inventory



Ø 81.3 x 16.3 mm
RoHS/RoHS II Compliant
MSL Level = 1

Product Dimension

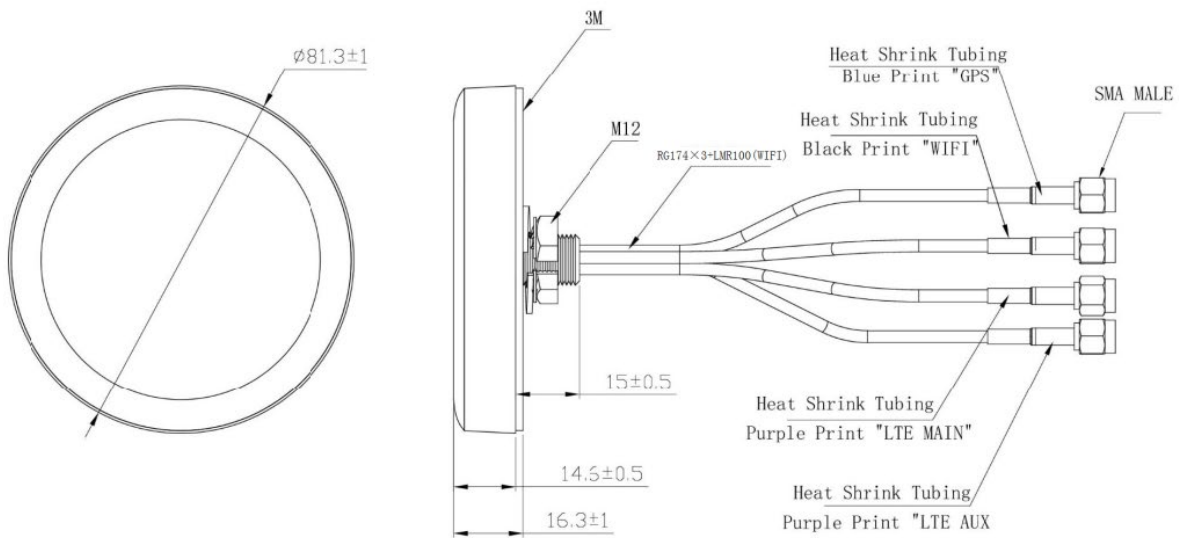
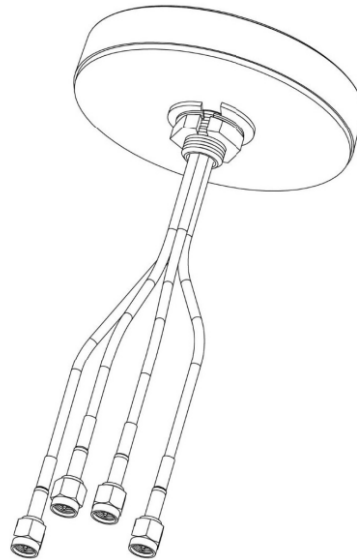

Unit: mm

External MIMO 2xLTE + Wi-Fi + GNSS COMBO ANTENNA



AECW0801C09

Request Samples



Check Inventory



Ø 81.3 x 16.3 mm
RoHS/RoHS II Compliant
MSL Level = 1

Test Measurement - VSWR

GNSS Antenna

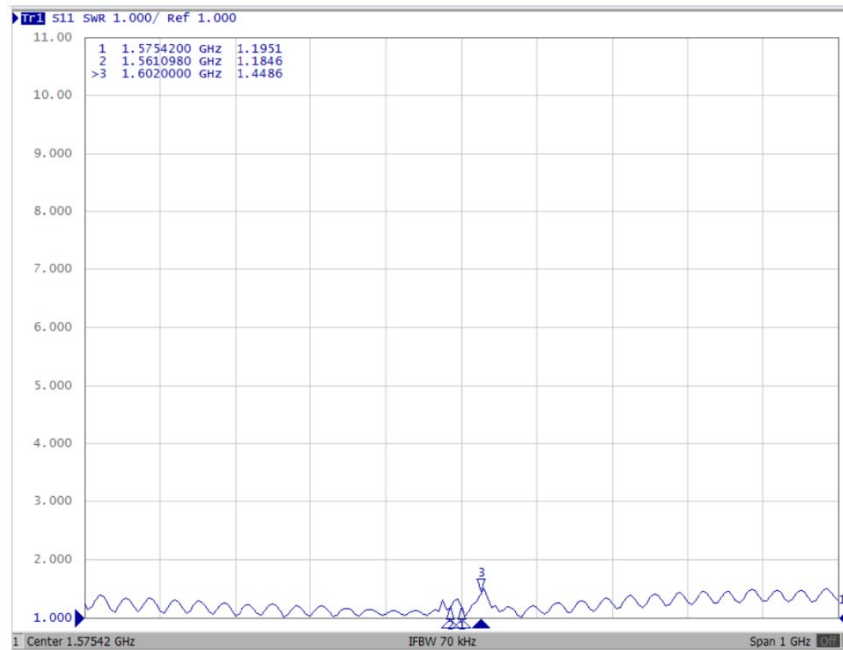

LTE Antenna – Main & Aux

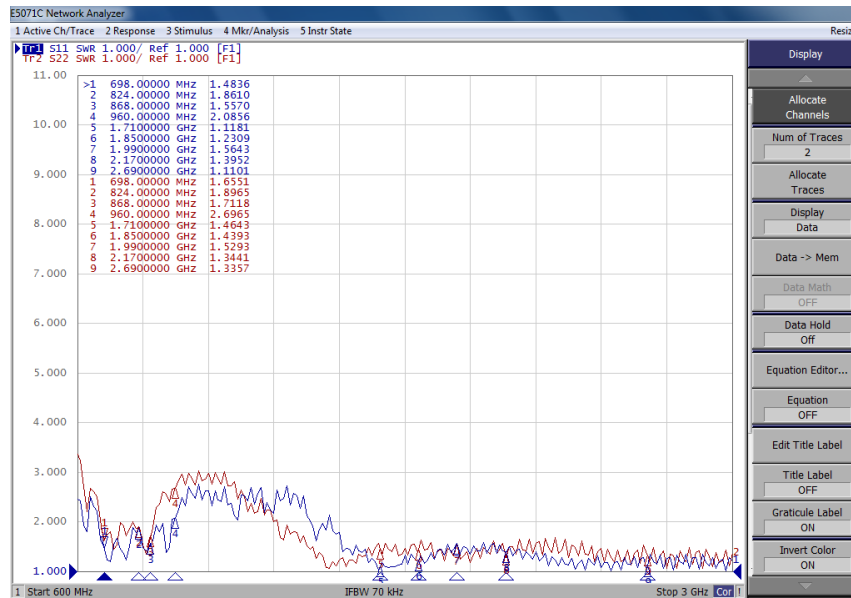

5101 Hidden Creek Ln Spicewood TX 78669
Phone: 512-371-6159 | Fax: 512-351-8858
For terms and conditions of sales, please visit:
www.abracon.com

REVISED: 05-08-20

ABRACON IS
ISO9001-2015
CERTIFIED

External MIMO 2xLTE + Wi-Fi + GNSS COMBO ANTENNA



AECW0801C09

Request Samples



Check Inventory



Ø 81.3 x 16.3 mm
RoHS/RoHS II Compliant
MSL Level = 1

Wi-Fi Antenna

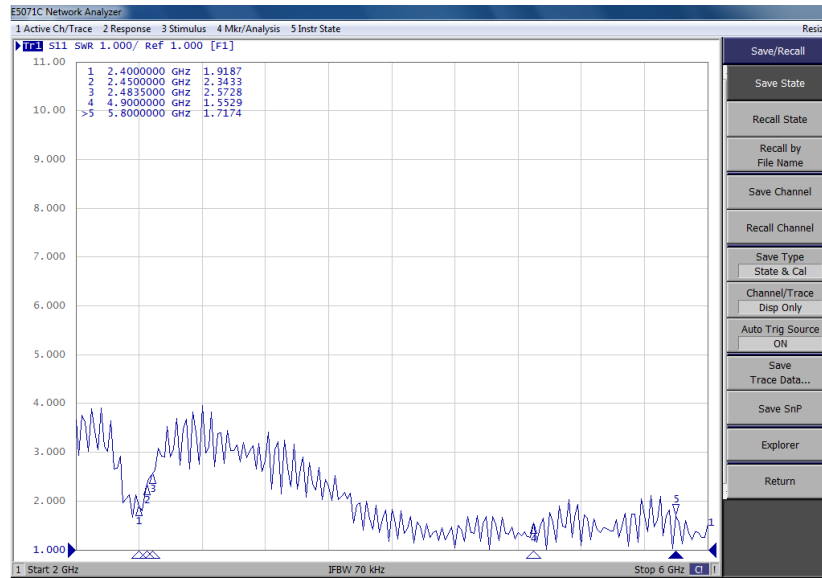

External MIMO 2xLTE + Wi-Fi + GNSS COMBO ANTENNA



AECW0801C09

Request Samples



Check Inventory



Ø 81.3 x 16.3 mm
RoHS/RoHS II Compliant
MSL Level = 1

Radiation Characteristics

2D Pattern

GNSS

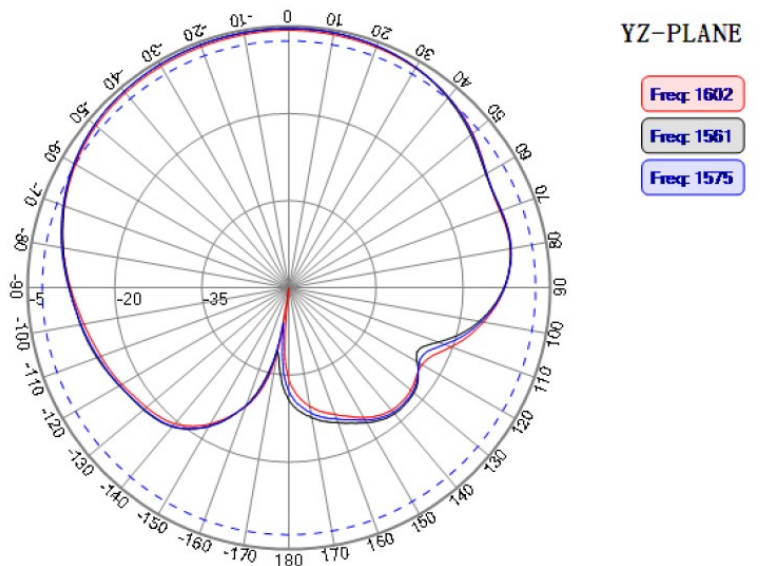
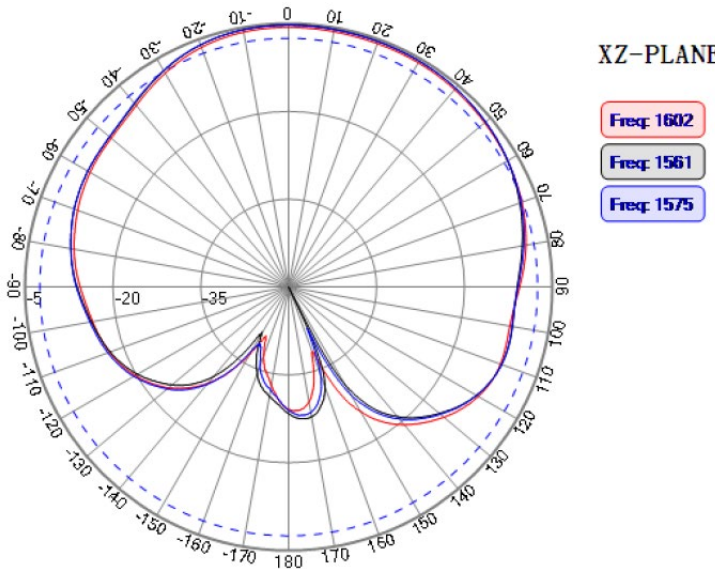
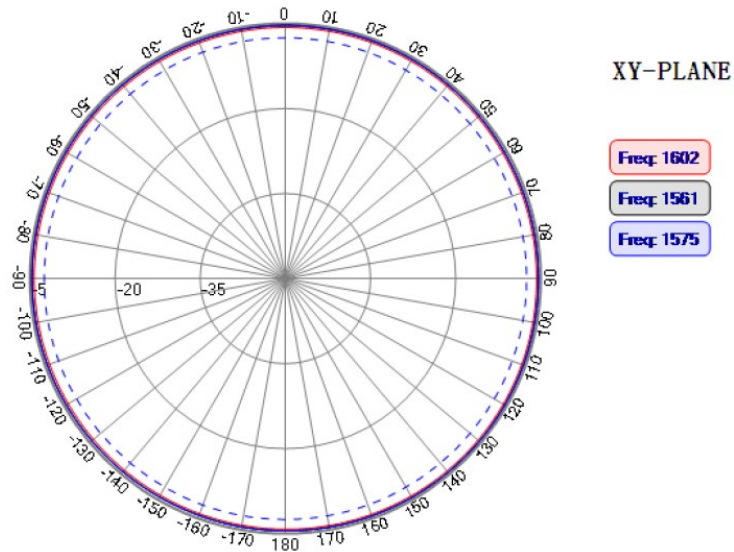

External MIMO 2xLTE + Wi-Fi + GNSS COMBO ANTENNA



AECW0801C09

Request Samples



Check Inventory



Ø 81.3 x 16.3 mm
RoHS/RoHS II Compliant
 MSL Level = 1

LTE - Main

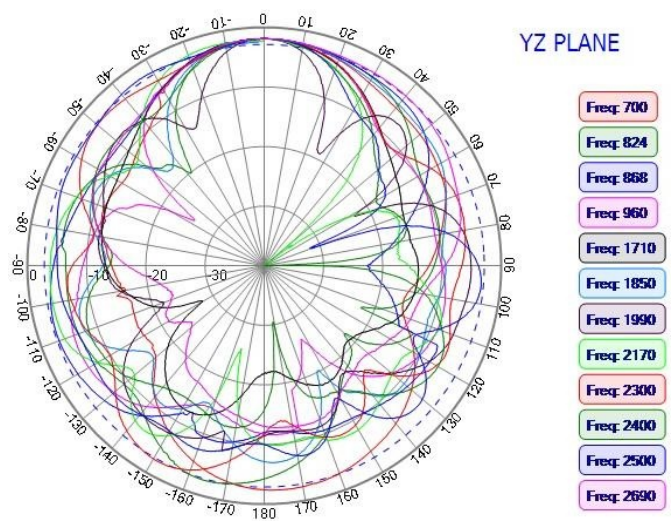
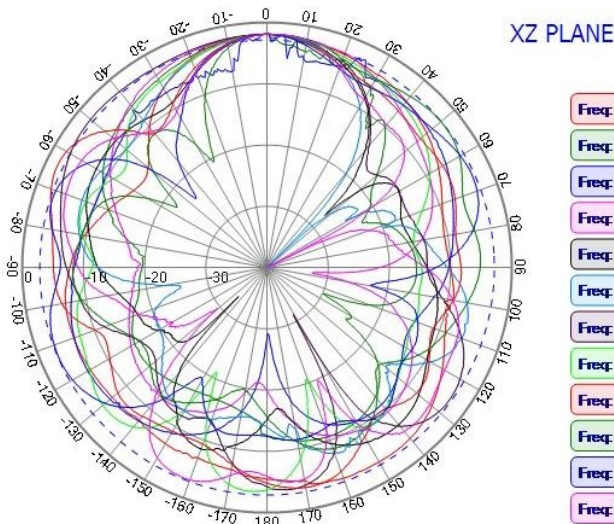
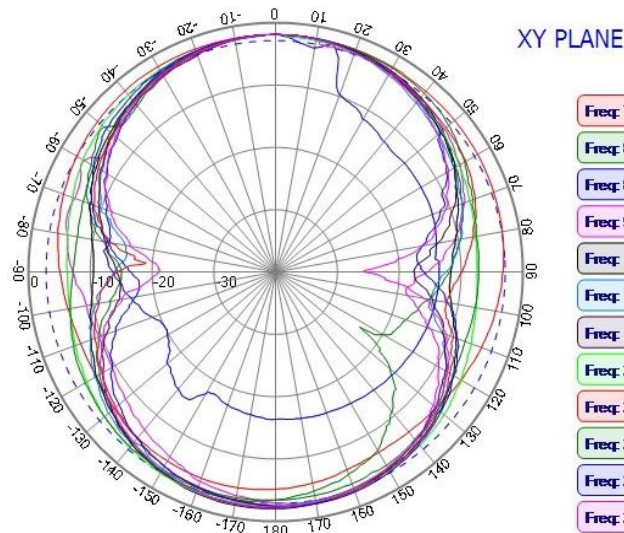

5101 Hidden Creek Ln Spicewood TX 78669
 Phone: 512-371-6159 | Fax: 512-351-8858
 For terms and conditions of sales, please visit:
www.abracon.com

REVISED: 05-08-20

ABRACON IS
 ISO9001-2015
 CERTIFIED

External MIMO 2xLTE + Wi-Fi + GNSS COMBO ANTENNA



AECW0801C09

Request Samples



Check Inventory



Ø 81.3 x 16.3 mm
RoHS/RoHS II Compliant
 MSL Level = 1

LTE - Aux

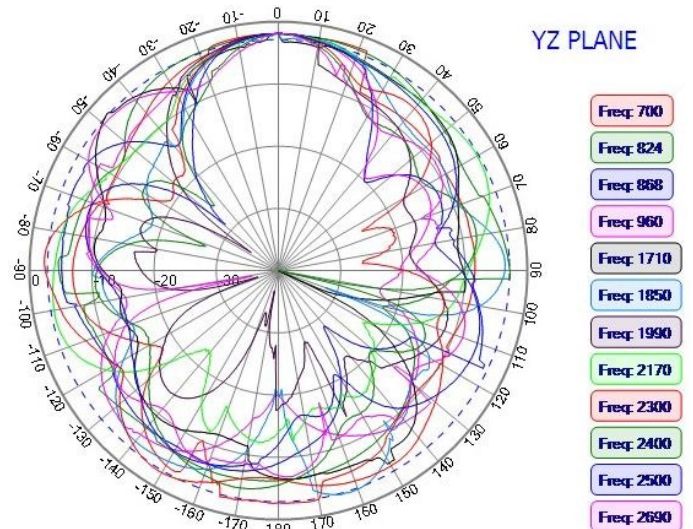
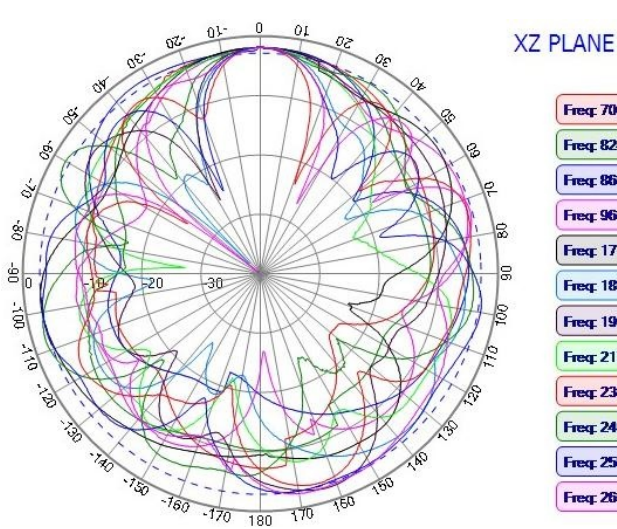
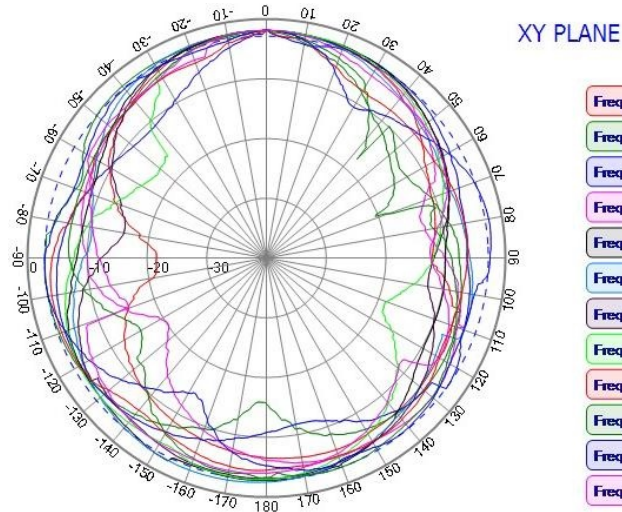

5101 Hidden Creek Ln Spicewood TX 78669
 Phone: 512-371-6159 | Fax: 512-351-8858
 For terms and conditions of sales, please visit:
www.abracon.com

REVISED: 05-08-20

ABRACON IS
 ISO9001-2015
 CERTIFIED

External MIMO 2xLTE + Wi-Fi + GNSS COMBO ANTENNA



AECW0801C09

Request Samples



Check Inventory



Ø 81.3 x 16.3 mm
RoHS/RoHS II Compliant
MSL Level = 1

Wi-Fi

2400~2483.5 MHz

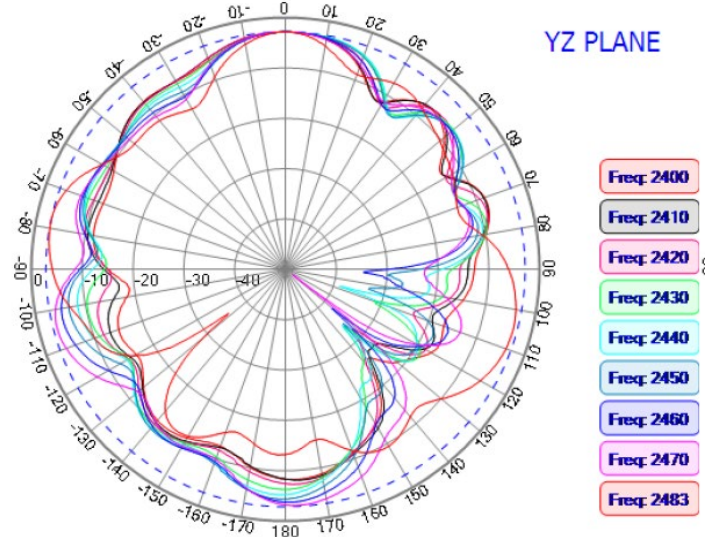
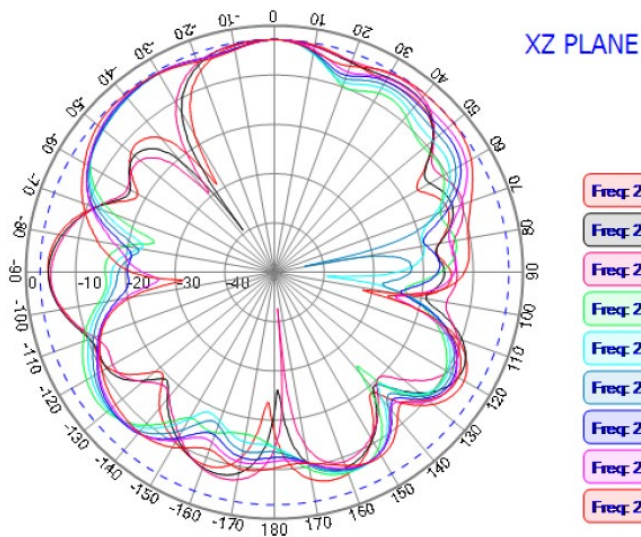
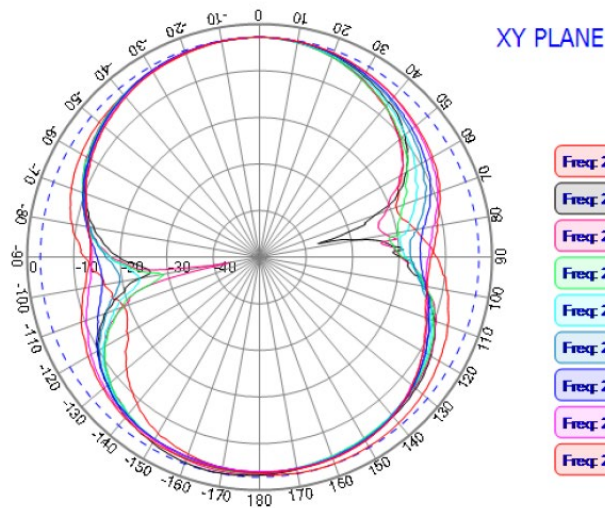

5101 Hidden Creek Ln Spicewood TX 78669
Phone: 512-371-6159 | Fax: 512-351-8858
For terms and conditions of sales, please visit:
www.abracon.com

REVISED: 05-08-20

ABRACON IS
ISO9001-2015
CERTIFIED

External MIMO 2xLTE + Wi-Fi + GNSS COMBO ANTENNA



AECW0801C09

Request Samples



Check Inventory



Ø 81.3 x 16.3 mm
RoHS/RoHS II Compliant
 MSL Level = 1

4900~5800 MHz

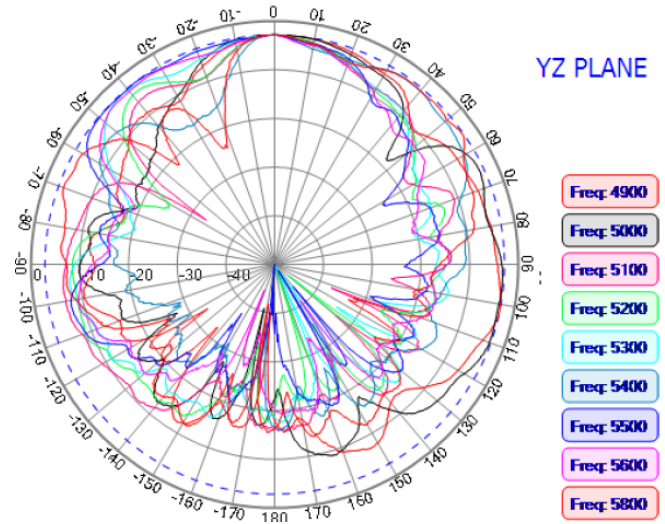
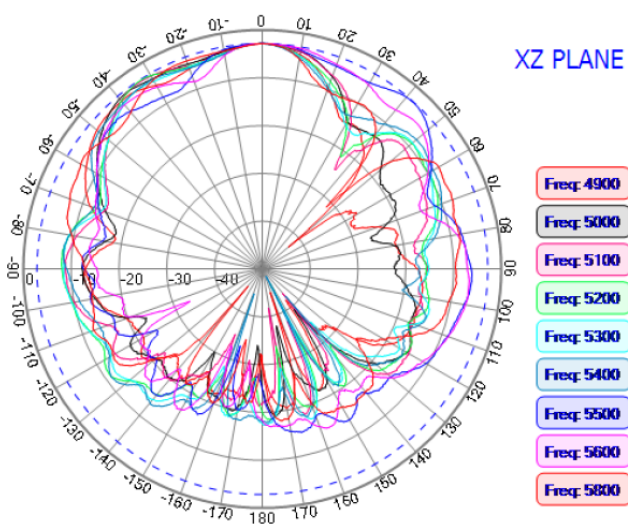
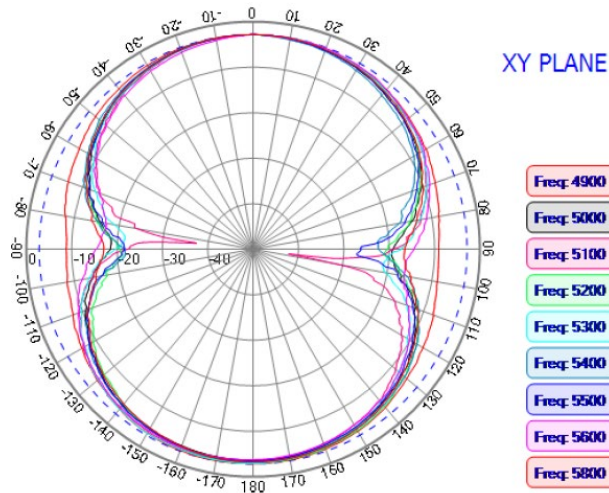

5101 Hidden Creek Ln Spicewood TX 78669
 Phone: 512-371-6159 | Fax: 512-351-8858
 For terms and conditions of sales, please visit:
www.abracon.com

REVISED: 05-08-20

ABRACON IS
 ISO9001-2015
 CERTIFIED

External MIMO 2xLTE + Wi-Fi + GNSS COMBO ANTENNA



AECW0801C09

Request Samples



Check Inventory



Ø 81.3 x 16.3 mm
RoHS/RoHS II Compliant
MSL Level = 1

3D Pattern

GNSS

1561 MHz

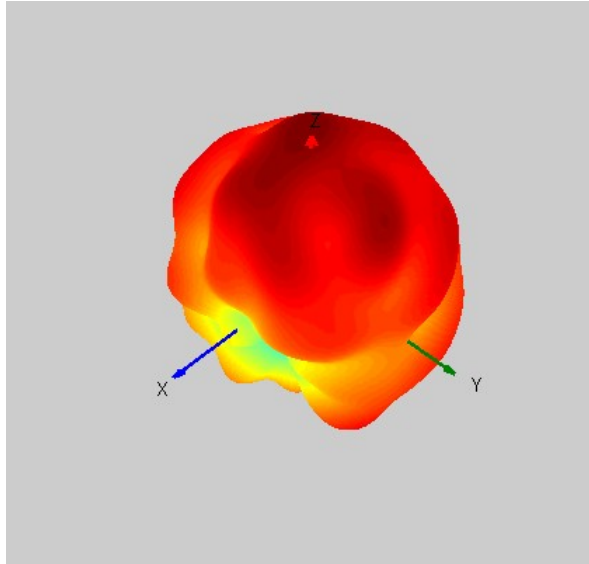

1575 MHz

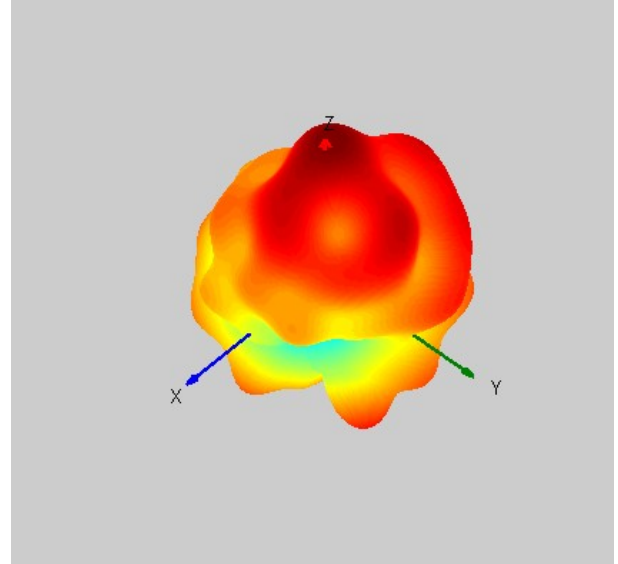

1602 MHz

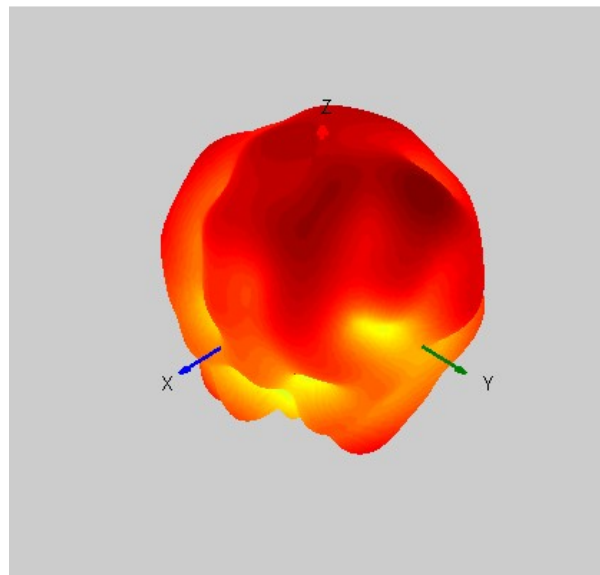

External MIMO 2xLTE + Wi-Fi + GNSS COMBO ANTENNA



AECW0801C09

Request Samples



Check Inventory



Ø 81.3 x 16.3 mm
RoHS/RoHS II Compliant
MSL Level = 1

LTE - Main

698 MHz

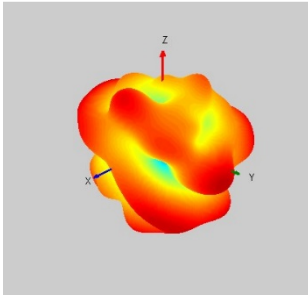

824 MHz

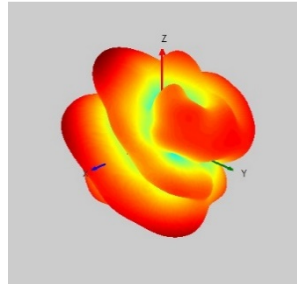

868 MHz

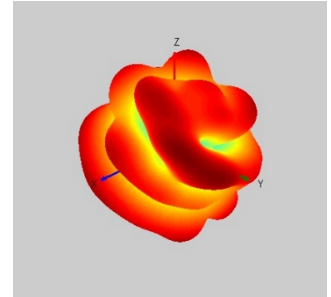

960 MHz

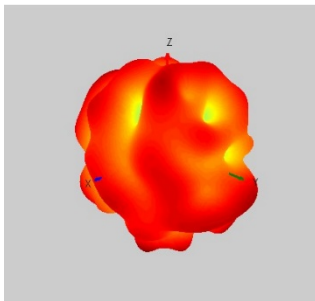

1710 MHz

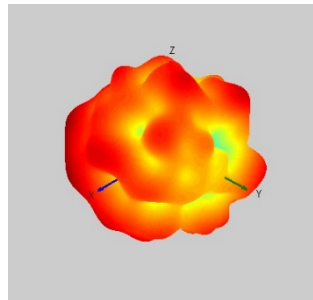

1850 MHz

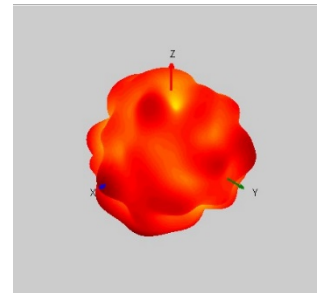

1990 MHz

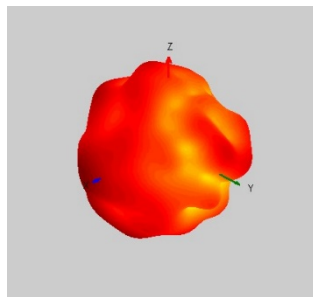

2170 MHz

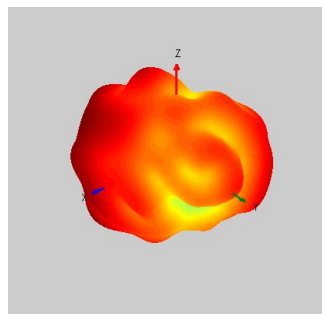

2300 MHz

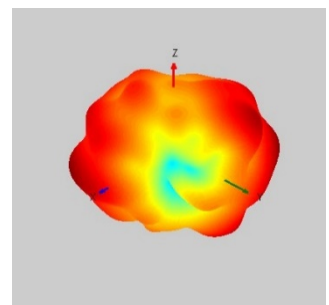

2500 MHz

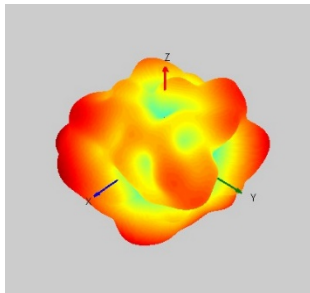

2690 MHz

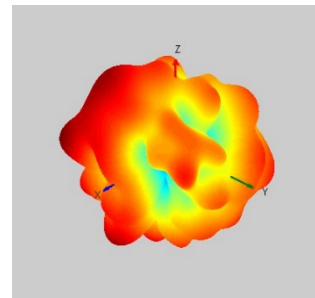

5101 Hidden Creek Ln Spicewood TX 78669
Phone: 512-371-6159 | Fax: 512-351-8858
For terms and conditions of sales, please visit:
www.abracon.com

REVISED: 05-08-20

ABRACON IS
ISO9001-2015
CERTIFIED

External MIMO 2xLTE + Wi-Fi + GNSS COMBO ANTENNA



AECW0801C09

Request Samples



Check Inventory



Ø 81.3 x 16.3 mm
RoHS/RoHS II Compliant
MSL Level = 1

LTE - Aux

698 MHz

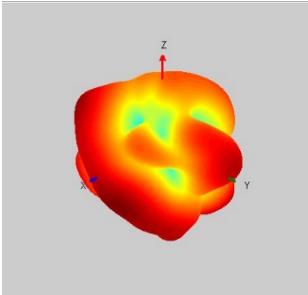

824 MHz

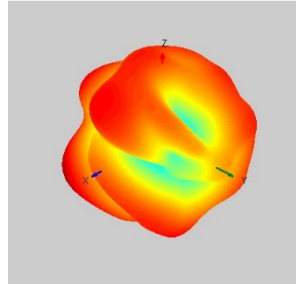

868 MHz

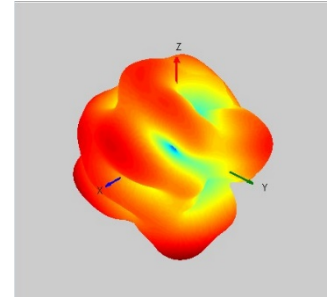

960 MHz

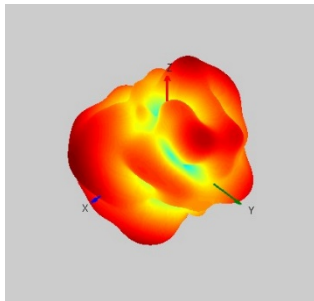

1710 MHz

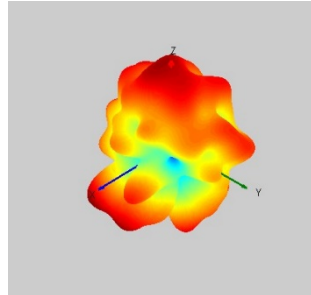

1850 MHz

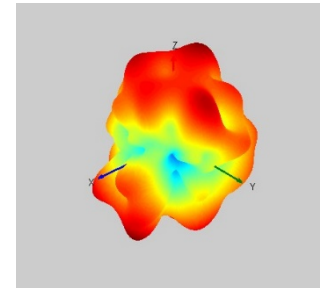

1990 MHz

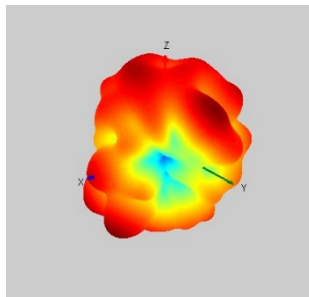

2170 MHz

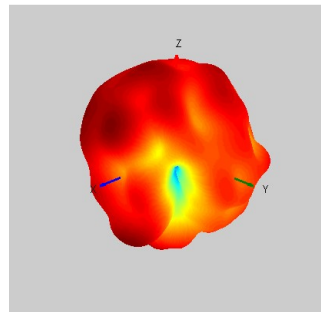

2300 MHz

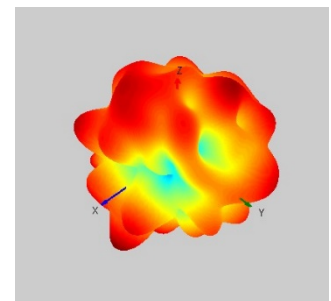

2500 MHz

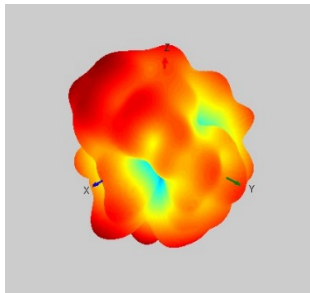

2690 MHz

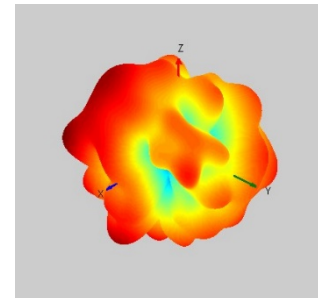

External MIMO 2xLTE + Wi-Fi + GNSS COMBO ANTENNA



AECW0801C09

Request Samples



Check Inventory



Ø 81.3 x 16.3 mm
RoHS/RoHS II Compliant
MSL Level = 1

Wi-Fi

2400 MHz

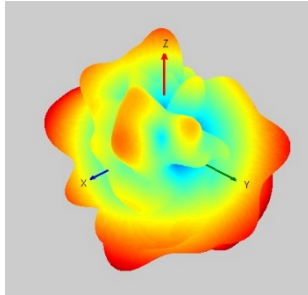

2420 MHz

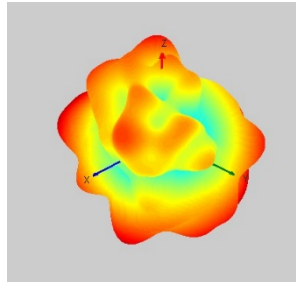

2440 MHz

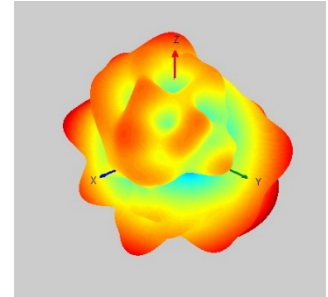

2460 MHz

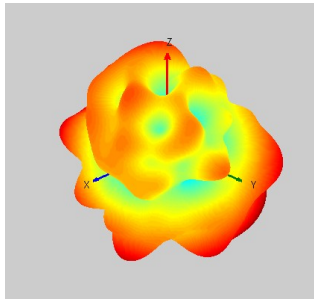

2483 MHz

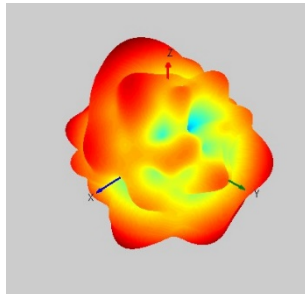

4900 MHz

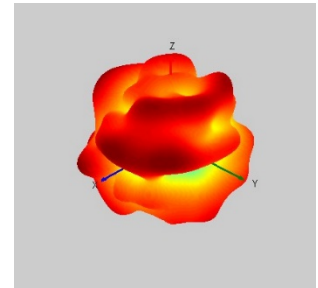

5200 MHz

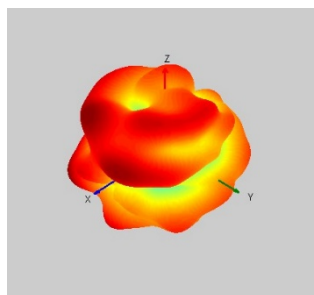

5500 MHz

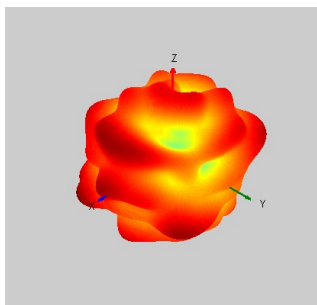

5800 MHz

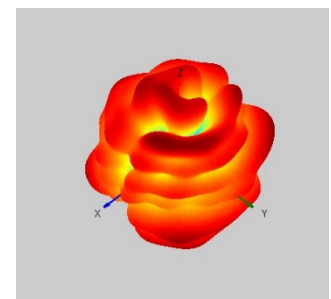

External MIMO 2xLTE + Wi-Fi + GNSS COMBO ANTENNA



AECW0801C09

Request Samples



Check Inventory



Ø 81.3 x 16.3 mm
RoHS/RoHS II Compliant
MSL Level = 1

Gain and Efficiency

LTE – Main and Aux

Frequency (MHz)	Main		Aux	
	Gain (dBi)	Efficiency	Gain (dBi)	Efficiency
698	0.63	0.57	-0.91	0.53
824	2.87	0.61	2.91	0.57
868	1.86	0.58	2.13	0.59
960	0.33	0.53	-1.84	0.50
1710	0.45	0.48	0.65	0.56
1850	-0.17	0.52	-0.93	0.57
1990	-0.25	0.56	0.16	0.53
2170	1.41	0.53	-0.19	0.52
2300	0	0.57	-0.53	0.51
2500	0.29	0.56	-1.05	0.49
2690	-0.21	0.58	-0.08	0.50

Wi-Fi

Frequency (MHz)	Gain (dBi)	Efficiency
2400	-0.29	0.48
2420	-0.17	0.51
2440	-0.5	0.53
2460	-0.73	0.47
2483	-1.36	0.46
4900	1.05	0.56
5200	1.02	0.51
5500	0.07	0.57
5800	3.07	0.73

Packaging Information

Number of antennas/ cartons : 50
Dimension of the carton : 700 x 320 x 155 mm
Weight of the carton : 14 kg
Weight of 1 pc of antenna : 250 g

ATTENTION: Abracon LLC's products are COTS – Commercial-Off-The-Shelf products; suitable for Commercial, Industrial and, where designated, Automotive Applications. Abracon's products are not specifically designed for Military, Aviation, Aerospace, Life-dependent Medical applications or any application requiring high reliability where component failure could result in loss of life and/or property. For applications requiring high reliability and/or presenting an extreme operating environment, written consent and authorization from Abracon LLC is required. Please contact Abracon LLC for more information.



5101 Hidden Creek Ln Spicewood TX 78669
Phone: 512-371-6159 | Fax: 512-351-8858
For terms and conditions of sales, please visit:
www.abracon.com

REVISED: 05-08-20

ABRACON IS
ISO9001-2015
CERTIFIED