

SPECIFICATION SHEET

SPECIFICATION SHEET NO.	Q0301- XB32M00000S430
DATE	March 01, 2023
REVISION	A0
DESCRIPTION	MHz SMD Crystal, Seam Seal, L7.0*W5.0*H1.1mm, 4 Pads, CM75 series 32.0000MHz, Tolerance +/-30ppm, Load Capacitor 30pF, Frequency stability +/-30ppm @Operating Temp. Range -40°C ~+85°C, ESR 20 ohm Max, Reflow Profile Condition 260 °C Max. Tape/Reel, 1000pcs/Reel RoHS/RoHS III compliant
CUSTOMER	
CUSTOMER PART NUMBER	
CROSS REF. PART NUMBER	
ORIGINAL PART NUMBER	TGS CM75 32M0A30-30-30-40-20TLF
PART CODE	XB32M00000S430

VENDOR APPROVE			
Issued/Checked/Approved			
DATE: March 01, 2023			

CUSTOMER APPROVE	
DATE:	

03/01/2023

MAIN FEATURE

- SMD Crystal, Seam Seal, L7.0*W5.0*H1.1mm, 4 pads
- Low cost, High precision, High frequency stability
- Reflow Profile Condition 260 °C Max.
- Cross more competitors part
- RoHS/RoHS III compliant



APPLICATION

- Bluetooth, wireless communication set
- Communication Electronics

PART CODE GUIDE

RFQ

[Request For Quotation](#)

XB	32M00000	S	430
1	2	3	4

- 1) XB: Part family Code for SMD Crystal, Seam Seal, L7.0*W5.0*H1.1mm, 4 pads (CM75)
- 2) 32M00000: Frequency range code for 32.0000MHz
- 3) S: SMD type, Package Tape/Reel, 1000pcs/Reel
- 4) 430: Specification code for original part No.: **TGS CM75 32M0A30-30-30-40-20TLF**

DIMENSION (Unit: mm)

Image for reference

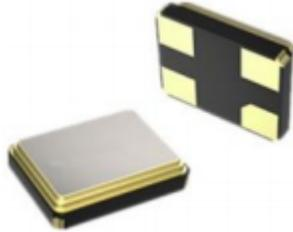

CM75

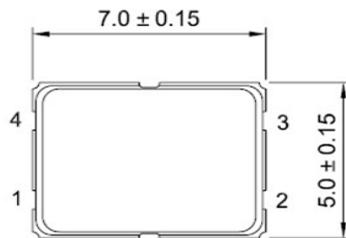

Marking
standard

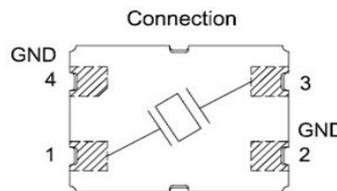
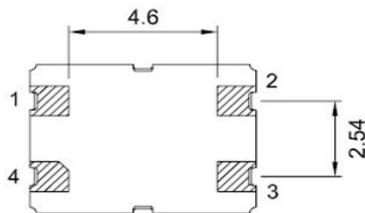

Connection
#1 Crystal
#2 Ground
#3 Crystal
#4 Ground



Recommend Pad Layout

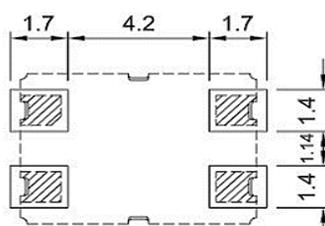

SMD CRYSTAL 7050 TYPE 4 PADS
ELECTRICAL PARAMETERS

Parameter	Part No. Symbol	Units	Value			Condition
			Min.	Typical	Max.	
Original Manufacturer	TGS	TGS Crystals				
Holder Type	CM75	SMD Crystal, Seam Seal, L7.0*W5.0*H1.1mm, 4 pads				
Frequency Range	32M0	MHz	32.0000			
Mode of Oscillation	A	AT Fundamental				
Frequency Tolerance	30	ppm	-30		+30	@25°C
Load Capacitance	-30	pF	30			
Stability over Operation Temperature	-30	ppm	-30		+30	
Operation Temperature	-40	°C	-40		+85	
Storage Temperature		°C	-55		+125	
Equivalent Series Resistance (ESR)	-20	Ω			20	
Drive Level		μW			300	
Shunt Capacitance (C0)		pF	0		7.0	
Motional Capacitance (C1)		fF	N/A			
DLD2		Ω	N/A			
FLD2		ppm	N/A			
RDL2		Ω	N/A			
SPDB		dB	N/A			
Aging		ppm/year			±3	@1 st year
Insulation Resistance		MΩ	500			@100VDC ± 15VDC
Others	Package	T	Tape/Reel			
	RoHS Status	LF	RoHS III compliant			
	Add Value		N/A			
	Internal Control Code *		N/A			

Note: 1) Original Part Number: **TGS CM75 32M0A30-30-30-40-20TLF**

2) * Internal Control Code- 2 letter or digits; Blank: N/A

03/01/2023

MECHANICAL PERFORMANCE

Item	Condition	Standard
Drop characteristics	Free drop from 75cm height on a hard wooden board for 3 times. (Board is thickness more than 30 mm.)	Frequency change: ≤5ppm Rr as specification
Shake characteristics	Shake frequency 10~55Hz, cyc1~2 minutes, swing 1.5mm, direction x/y/z, all 30 minutes, test after 1 hours.	Frequency change: ≤5ppm Rr as specification
Airproof characteristics	Put crystal into the pressure cabin with alcohol, keep pressure 0.4~0.5mpa 10 minutes, then take out and blow for 5 minutes	IR≥500MΩ
Weld characteristics	260±5°C, 3 seconds	90% exhibit tin ok
Humidity characteristics	+40±2°C & 90%~95% R.H. 250 hours	Frequency change: ≤5ppm Rr as specification
Low temperature characteristics	-30±2°C, 250 hours, put in room temperature, test after 1 hours.	Frequency change: ≤5ppm Rr as specification
High temperature characteristics	+85±2°C, 250 hours, put in room temperature, test after 1 hours.	Frequency change: ≤5ppm Rr as specification
Temperature cycling	-30±3°C/30±3 min~+85±2°C/30±3min, 5 cycles	Frequency change: ≤5ppm Rr as specification

SUGGESTED REFLOW PROFILE (For Reference Only)

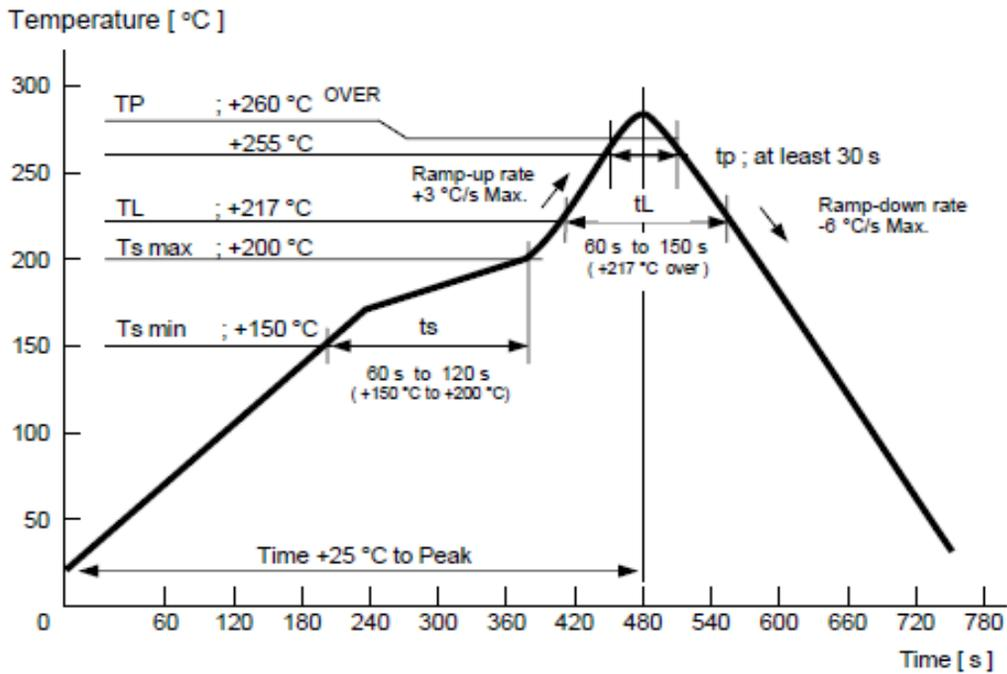

TAPE/REEL (Unit: mm)

All Devices are packed in accordance with EIA standard RS-481-2 and specifications., 1000pcs/Reel

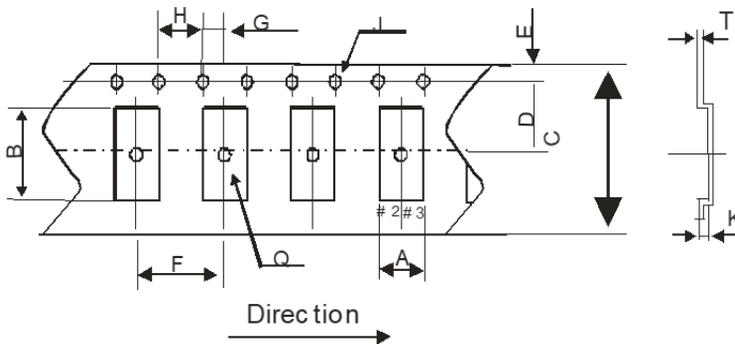
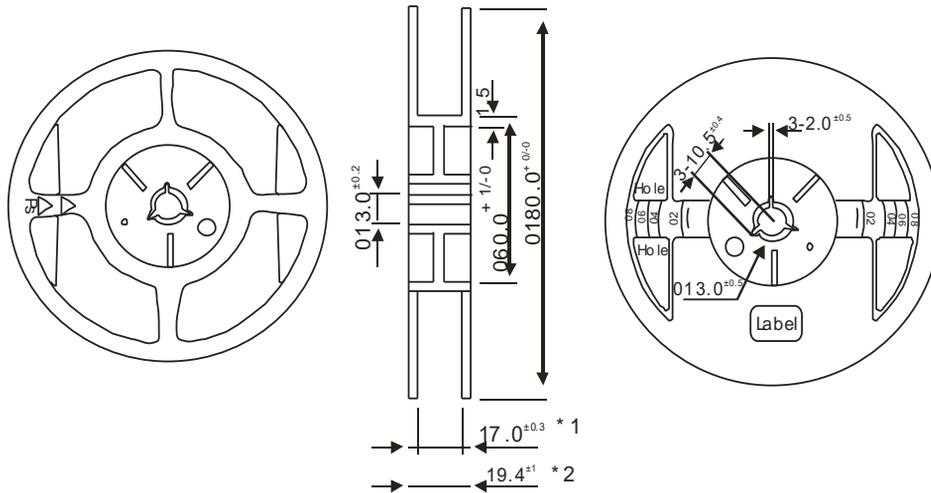

A	5.4 ^{±0.1}
B	7.4 ^{±0.1}
C	16.0 ^{±0.2}
D	7.5 ^{±0.1}
E	1.75 ^{±0.1}
F	8.0 ^{±0.1}
G	2.0 ^{±0.1}
H	4.0 ^{±0.1}
J	1.55 ^{±0.05}
K	1.4 ^{±0.1}
Q	1.6 ^{+0.1/0}
T	0.3 ^{±0.05}

Item		Empty Space
Tapa Leader	Cover Tape	Min.500mm
	Empty Pockets	Min.20 pockets
Tape Trailer	Cover Tape	Min.0mm
	Empty Pockets	Min.40mm

DISCLAIMER

NextGen Components, Inc. reserves the right to make changes to the product(s) and or information contained herein without notice. No liability is assumed as a result of their use or application. No rights under any patent accompany the sale of any such product(s) or information

03/01/2023