

High Power High Performance Molded Surface Mount Inductors

Model HM72B-06 Series

- Operating Temperature Range -40°C to +130°C
- Temperature Rise, Maximum +50°C
- Operating Frequency Up to 3MHz
- RoHS Compliant



**NOT SUPPORTED FOR NEW DESIGN
FOR AUTOMOTIVE DESIGNS, PLEASE REFER TO HA72L
FOR INDUSTRIAL DESIGNS, PLEASE REFER TO HM72L**

Part Number	Inductance ⁽¹⁾ μH±20%	Hea Current ⁽²⁾ (Adc)	Isat ⁽³⁾ (Adc)	DCR (mΩ)	
				Typ.	Max.
HM72B-06R10LF	0.10	26.2	45.0	1.5	1.7
HM72B-06R20LF	0.20	20.3	30.0	2.5	2.8
HM72B-06R33LF	0.33	18.0	22.0	3.2	3.9
HM72B-06R47LF	0.47	16.1	20.0	4.0	4.2
HM72B-06R68LF	0.68	14.4	16.5	5.0	5.5
HM72B-06R82LF	0.82	12.0	14.0	7.2	8.0
HM72B-061R0LF	1.00	10.3	14.0	9.0	10.0
HM72B-061R5LF	1.50	8.4	10.0	13.0	14.0
HM72B-062R2LF	2.20	8.3	8.5	15.0	20.0
HM72B-063R3LF	3.30	6.6	8.0	26.5	28.0
HM72B-064R7LF	4.70	5.4	6.5	35.0	40.0
HM72B-066R8LF	6.80	4.1	5.0	62.0	68.0
HM72B-06100LF	10.0	3.2	4.0	100.0	105.0
HM72B-06220LF	22.0	2.2	3.0	219.0	241.0
HM72B-06330LF	33.0	1.8	2.5	302.0	332.0

Notes:

- (1) Inductance is measured at 100 kHz, 0.1Vac without DC current.
- (2) The Heating Current is the DC current which causes the component temperature to increase by 50°C.
This current is determined by soldering the component on a typical application PCB, and then applying the current to the device for 30 minutes.
- (3) The saturation current (Isat) is the approximate current at which the inductance will be decreased by 20% typical from its initial (zero DC) value.

Outline Dimensions (mm)

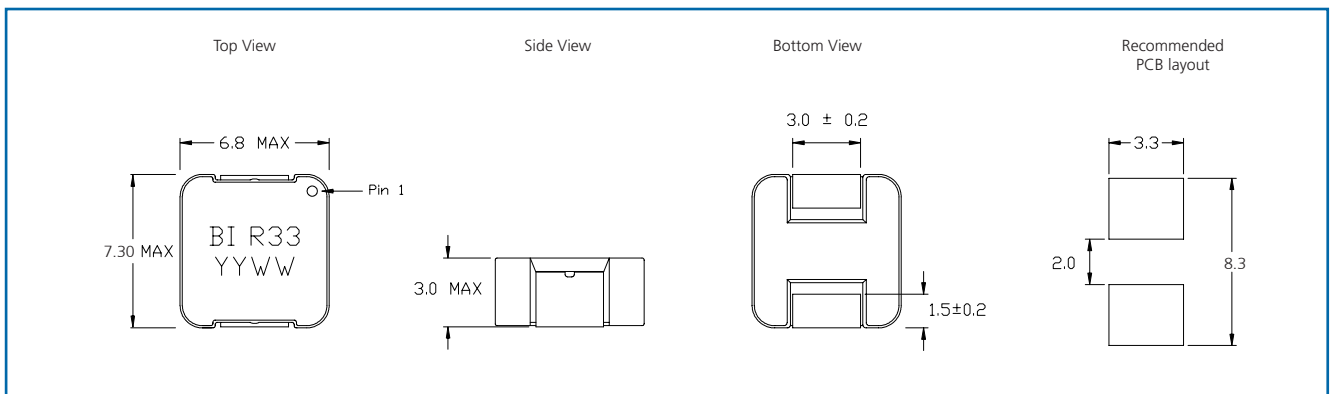

General Note

TT Electronics reserves the right to make changes in product specification without notice or liability.
All information is subject to TT Electronics' own data and is considered accurate at time of going to print.

Electrical Characteristic @ 25°C

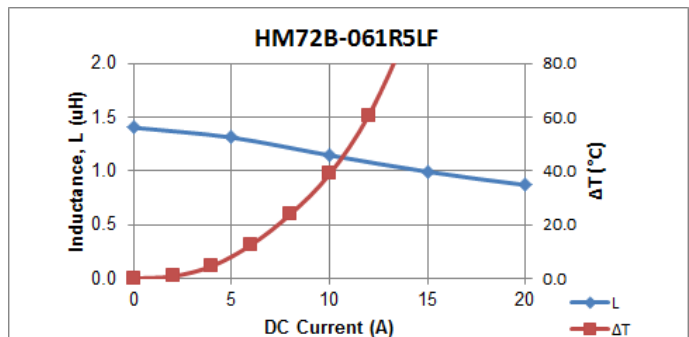
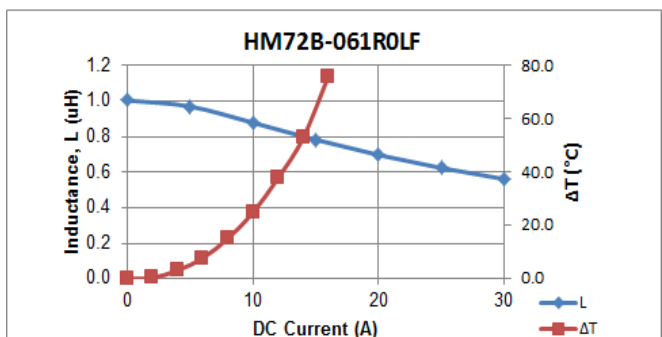
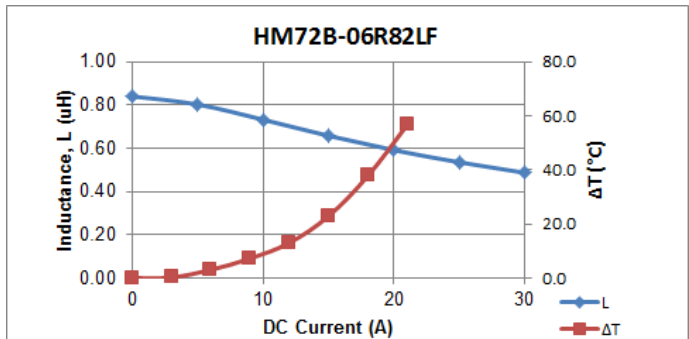
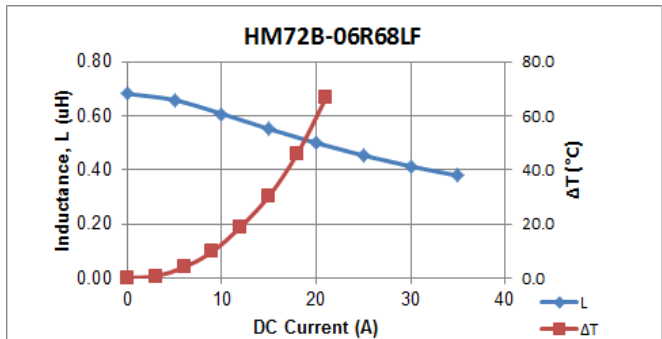
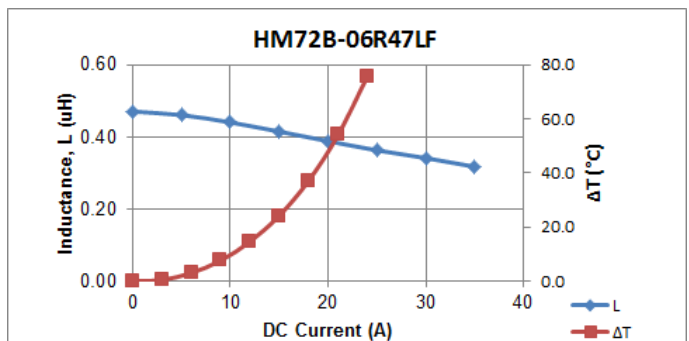
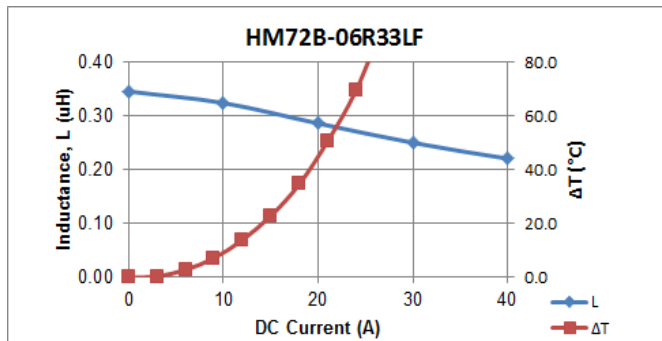
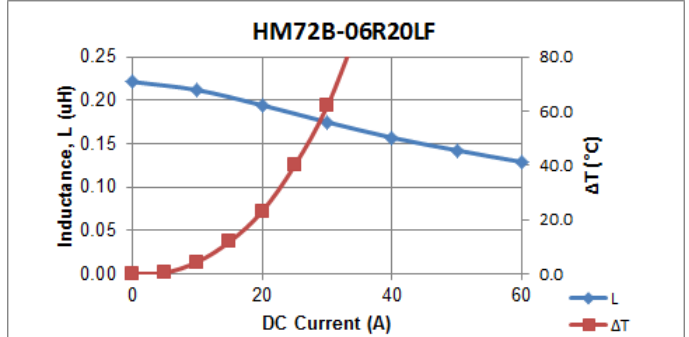
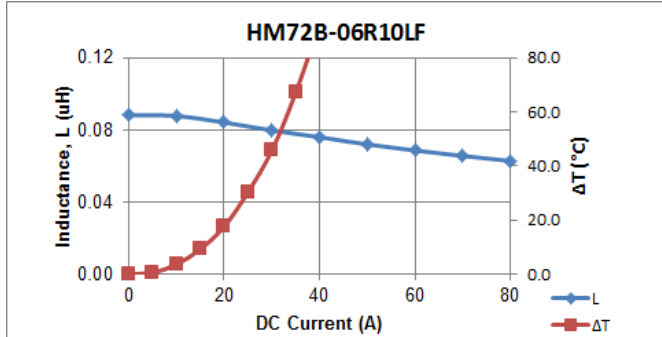

General Note

TT Electronics reserves the right to make changes in product specification without notice or liability.
All information is subject to TT Electronics' own data and is considered accurate at time of going to print.

BI Technologies
A-1445, Jalan Tanjung Api
25050 Kuantan
Pahang Darul Makmur
Malaysia

Ph: +60 9 565 8888 Fax: +60 9 514 3555

<http://www.ttelectronics.com/magnetics/customer-service-enquiry>

High Power High Performance Molded Surface Mount Inductors



Model HM72B-06 Series

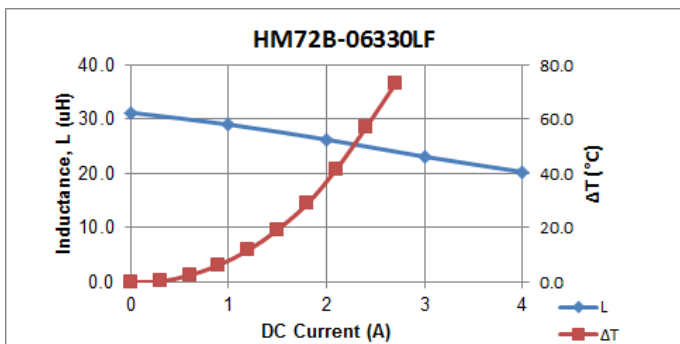
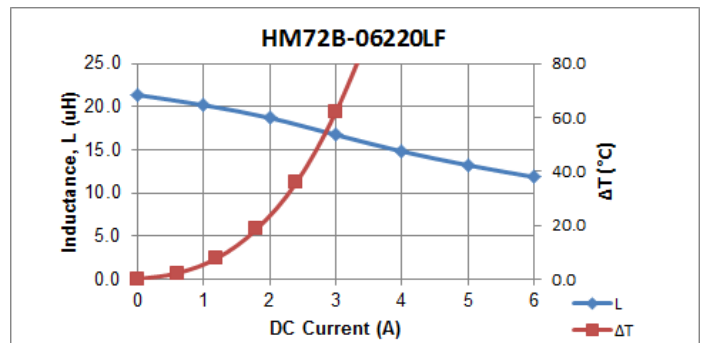
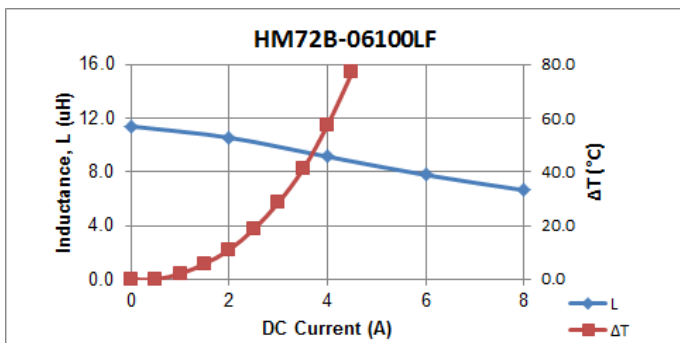
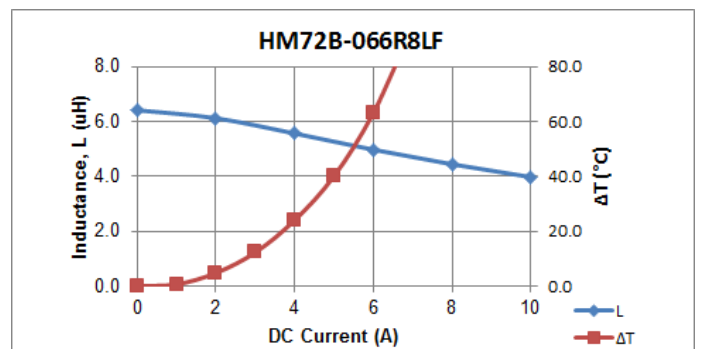
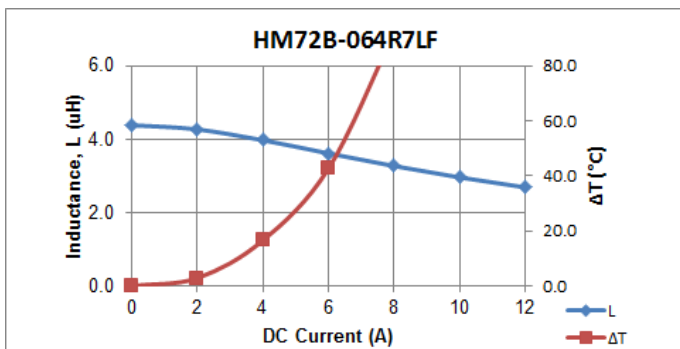
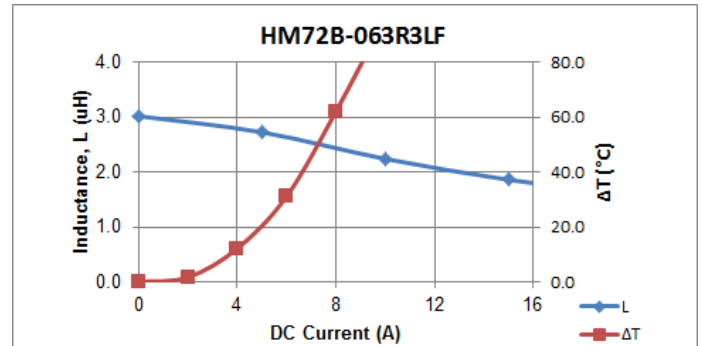
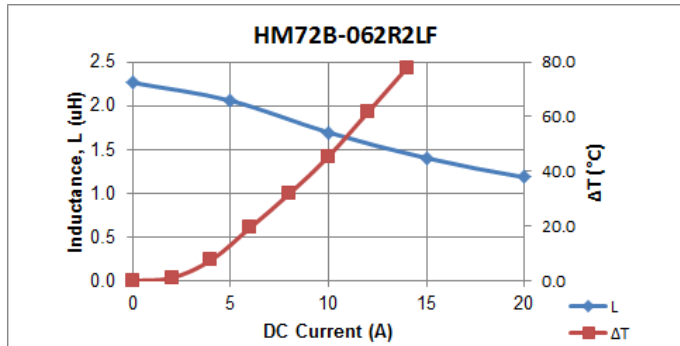

General Note

TT Electronics reserves the right to make changes in product specification without notice or liability.
All information is subject to TT Electronics' own data and is considered accurate at time of going to print.

Model HM72B-06 Series

Packaging / Ordering Information

One reel (13")	2000 pcs
One shipping carton (6 reels)	12000 pcs

Ordering Information

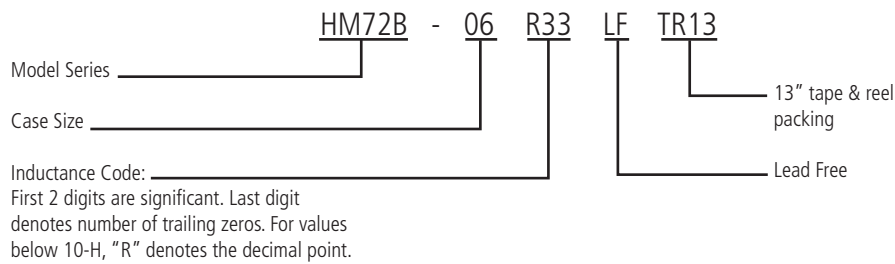

General Note

TT Electronics reserves the right to make changes in product specification without notice or liability. All information is subject to TT Electronics' own data and is considered accurate at time of going to print.