

DF-G1 Expert™ Dual Display Fiber Optic Light Receiver

Instruction Manual

Original Instructions
176768 Rev. D
9 September 2015



176768

Contents

| | |
|--|----|
| 1 Product Description | 3 |
| 1.1 Models | 3 |
| 1.2 Overview | 3 |
| 1.3 Top Panel Interface | 4 |
| 2 External Light Detection Considerations | 5 |
| 3 Installation Instructions | 7 |
| 3.1 Mounting Instructions | 7 |
| 3.2 Installing the Fibers | 7 |
| 3.3 Wiring Diagrams | 8 |
| 4 Operating Instructions | 9 |
| 4.1 Run Mode | 9 |
| 4.2 Program Mode | 9 |
| 4.2.1 TEACH Selection | 10 |
| 4.2.2 Response Speed | 11 |
| 4.2.3 Offset Percent | 11 |
| 4.2.4 Delays/Timers | 11 |
| 4.2.5 Display Readout | 12 |
| 4.2.6 Gain Selection | 12 |
| 4.2.7 Factory Defaults | 12 |
| 4.3 Remote Input | 12 |
| 4.4 Adjust Mode | 13 |
| 4.4.1 Two-Point TEACH | 13 |
| 4.4.2 Dynamic TEACH | 15 |
| 4.4.3 Window SET | 17 |
| 4.4.4 Light SET | 19 |
| 4.4.5 Dark SET | 21 |
| 4.4.6 Calibration SET | 23 |
| 4.4.7 Troubleshooting | 24 |
| 5 Specifications | 25 |
| 5.1 Dimensions | 26 |
| 6 Accessories | 27 |
| 6.1 Quick-Disconnect Cordsets | 27 |
| 7 Banner Engineering Corp Limited Warranty | 29 |

1 Product Description

Advanced sensor with dual digital displays for use with plastic and glass fiber optic assemblies

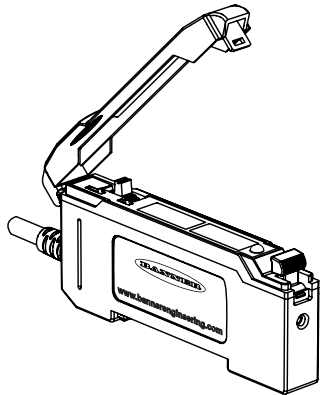

- A full feature DIN rail mounted fiber optic light receiver for external light detection
- Capable of detecting light level changes over all visible light colors plus infrared and near ultraviolet
- Easy to apply in many LED and lamp inspection stations
- Easy to read dual digital displays show both signal level and threshold simultaneously
- Lever action fiber clamp provides stable, reliable, and trouble-free fiber clamping
- Simple user interface ensures easy sensor set-up and programming via displays and switches/buttons or remote input teach wire
- TEACH and SET methods ensure optimal gain and threshold settings
- Operates over a wide range of light levels
- User has full control over all operating parameters: threshold, Light Operate or Dark Operate, output timing functions, gain level, and response speed
- Response speeds of 50 ms and 150 ms
- Sleek 10 mm wide housing mounts to 35 mm DIN rail



WARNING: Not To Be Used for Personnel Protection

Never use this device as a sensing device for personnel protection. Doing so could lead to serious injury or death. This device does not include the self-checking redundant circuitry necessary to allow its use in personnel safety applications. A sensor failure or malfunction can cause either an energized or de-energized sensor output condition.

1.1 Models

| Model | Outputs | Connector ¹ |
|-------------|------------|---|
| DF-G1-NR-2M | Single NPN | 2 m (6.5 ft) cable, 4-wire |
| DF-G1-PR-2M | Single PNP | |
| DF-G1-NR-Q5 | Single NPN | 150 mm (6 in) PVC pigtail, M12 Euro QD connector, 4-pin |
| DF-G1-PR-Q5 | Single PNP | |
| DF-G1-NR-Q7 | Single NPN | Integral M8 Pico QD connector, 4-pin |
| DF-G1-PR-Q7 | Single PNP | |

1.2 Overview

The DF-G1 is an easy-to-use, DIN-rail-mountable fiber optic light receiver. It provides high-performance sensing for external light applications.

The sensor's compact housing has dual digital displays (Red/Green) and a bright output LED for easy programming and status monitoring during operation. The sensor features a single discrete output, either NPN or PNP, by model.

An accessory clamp is available to secure a bank of connected sensors together on a DIN rail (see [Accessories](#) on page 27).

¹ Connector options:

- A model with a QD connector requires a mating cordset (see [Quick-Disconnect Cordsets](#) on page 27).
- For 9 m cable, change the suffix 2M to 9M in the 2 m model number (example, DF-G1-NR-9M).
- For 150 mm (6 in) PVC pigtail, M8 Pico QD connector, 4-pin change the suffix 2M to Q3 in the 2 m model number (example, DF-G1-NR-Q3).

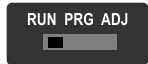

Figure 1. DF-G1 Model Features

| | |
|---|--------------------------|
| 1 | Output LED |
| 2 | LO/DO Switch |
| 3 | RUN/PRG/ADJ Mode Switch |
| 4 | Lever Action Fiber Clamp |
| 5 | Red Signal Level |
| 6 | Green Threshold |
| 7 | + /SET/- Rocker Button |

1.3 Top Panel Interface

Opening the dust cover provides access to the top panel interface. The top panel interface consists of the RUN/PRG/ADJ mode switch, LO/DO switch, +/SET/- rocker button, dual red/green digital displays, and output LED.



RUN/PRG/ADJ Mode Switch

The RUN/PRG/ADJ mode switch puts the sensor in RUN, PRG (Program), or ADJ (Adjust) mode. RUN mode allows the sensor to operate normally and prevents unintentional programming changes via the +/SET/- rocker button. PRG mode allows the sensor to be programmed through the display-driven programming menu (see [Program Mode](#) on page 9). ADJ mode allows the user to perform Expert TEACH/SET methods and Manual Adjust (see [Adjust Mode](#) on page 13).



LO/DO Switch

The LO/DO switch selects Light Operate or Dark Operate mode. In Light Operate mode, the output is ON when the sensing condition is above the threshold. (For Window SET, the output is ON when the sensing condition is inside the window.) In Dark Operate mode, the output is ON when the sensing condition is below the threshold. (For Window SET, the output is ON when the sensing condition is outside the window.)

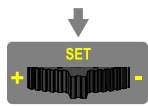

+ /SET/- Rocker Button

The +/SET/- rocker button is a 3-way button. The +/- positions are engaged by rocking the button left/right. The SET position is engaged by clicking down the button while the rocker is in the middle position. All three button positions are used during PRG mode to navigate the display-driven programming menu. During ADJ mode, SET is used to perform TEACH/SET methods and +/- are used to manually adjust the threshold(s). The rocker button is disabled during RUN mode, except when using Window SET, see [Window SET](#) on page 17.



Red/Green Digital Displays

During RUN and ADJ modes, the Red display shows the signal level, and the Green display shows the threshold. During PRG mode, both displays are used to navigate the display-driven programming menu.



Output LED

The output LED provides a visible indication when the output is activated.

2 External Light Detection Considerations

External lighting variations must be carefully considered when applying this sensor because the amount of background light can measurably affect detection reliability.

The DF-G1 Fiber Optic Light Receiver detects both the light of interest and ambient light. [Figure 2](#) on page 5 shows simulated light levels for both the dark state and the light state. The dark state is the amount of light detected when the external light of interest is not present. Conversely, the light state is the amount of light detected when both the ambient and external light of interest are present. In the dark state, the graph shows that light detected can change with time. Changes in the dark state light levels are caused by variations in the ambient light levels (perhaps sunlight or factory light variations). Typical variations in the detected light level when the external light of interest is present (light state) are also shown in the figure. Note again that the light level can vary with changes in the ambient light level.

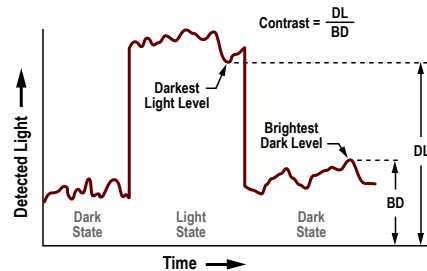

Figure 2. Light Levels

A successful sensing application is obtained when the sensor can detect between the light and dark conditions. Two important points shown in [Figure 2](#) on page 5 are the brightest dark level (BD) and the darkest light level (DL). These values represent the key values for determining if the application will be successfully detected. The application goal is to maximize the light level detected in the darkest light state. Using this concept of contrast, calculate the contrast available to ensure a good sensing application. The contrast should be greater than 2 for robust sensing applications.

$$\text{Contrast} = DL/BD$$

The DF-G1 Fiber Optic Light Receiver detects light over a wide range of the light spectrum and over a wide range of light intensity. [Table 1](#) on page 5 and [Table 2](#) on page 5 depict the typical minimum light intensity as well as the maximum light intensity values that can be detected. Use the tables as a guide for comparing detectable light levels for various light sources. In [Table 1](#) on page 5, values for the light intensity are in Lux and in [Table 2](#) on page 5 values for light intensity are in $\mu\text{W}/\text{cm}^2$.

Table 1: Typical Light Detection Capabilities in Lux

| Light Source | PIT26U | | PIT66U | | Glass Fiber IMT.756.6S-HT | |
|----------------|---------|---------|---------|---------|---------------------------|---------|
| | Minimum | Maximum | Minimum | Maximum | Minimum | Maximum |
| Green (535 nm) | 3.0 | 50,000 | 0.9 | 15,000 | 0.9 | 15,000 |
| Red (626 nm) | 1.0 | 16,000 | 0.3 | 4,800 | 0.3 | 4,800 |
| Blue (485 nm) | 0.7 | 11,000 | 0.4 | 3,300 | 0.4 | 3,300 |
| White (cool) | 3.0 | 50,000 | 0.9 | 15,000 | 0.9 | 15,000 |

Table 2: Typical Light Detection Capabilities in $\mu\text{W}/\text{cm}^2$

| Light Source | PIT26U | | PIT66U | | Glass Fiber IMT.756.6S-HT | |
|-------------------|---------|---------|---------|---------|---------------------------|---------|
| | Minimum | Maximum | Minimum | Maximum | Minimum | Maximum |
| Green (535 nm) | 0.5 | 7,500 | 0.2 | 2,250 | 0.2 | 2,250 |
| Red (626 nm) | 0.5 | 7,500 | 0.2 | 2,250 | 0.2 | 2,250 |
| Blue (485 nm) | 0.6 | 9,000 | 0.3 | 2,700 | 0.3 | 2,700 |
| White (cool) | 0.5 | 7,500 | 0.2 | 2,250 | 0.2 | 2,250 |
| Infrared (850 nm) | 2.0 | 30,000 | 0.6 | 9,000 | 0.1 | 1,500 |

DF-G1 Expert™ Dual Display Fiber Optic Light Receiver

The two tables above are a guide for detecting external lights. The sensor does not measure absolute light levels. It detects the presence of an external light source based on the received light intensity relative to a user-set threshold. These tables demonstrate that the sensor will detect light sources typical in many industrial applications and highlights that the selection of the fiber optic cable diameter affects the limits of light detection.

3 Installation Instructions

3.1 Mounting Instructions

Mount on a DIN Rail

1. Hook the DIN rail clip on the bottom of the DF-G1 over the edge of the DIN rail (1).
2. Push the DF-G1 up on the DIN rail (1).
3. Pivot the DF-G1 onto the DIN rail, pressing until it snaps into place (2).

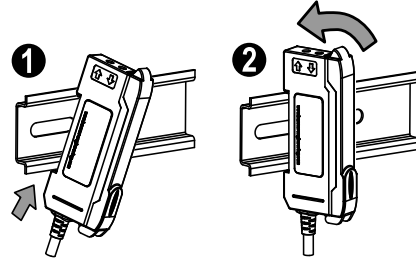

Mount to the Accessory Bracket

1. Position the DF-G1 in the SA-DIN-BRACKET.
2. Insert the supplied M3 screws.
3. Tighten the screws.

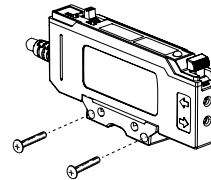

Remove from a DIN rail

1. Push the DF-G1 up on the DIN rail (1).
2. Pivot the DF-G1 away from the DIN rail and remove it (2).

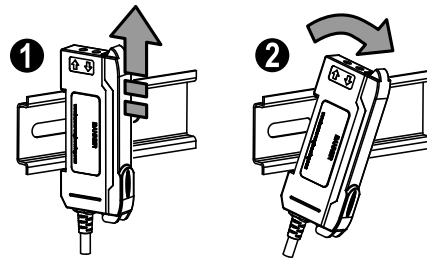

3.2 Installing the Fibers

Follow these steps to install glass or plastic fibers.

1. Open the dust cover.
2. Move the fiber clamp forward to unlock it.
3. Insert the fiber(s) into the fiber port(s) until they stop.
4. Move the fiber clamp backward to lock the fiber(s).
5. Close the dust cover.

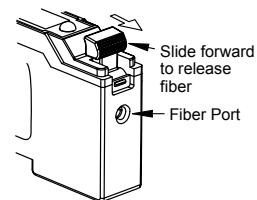

3.3 Wiring Diagrams

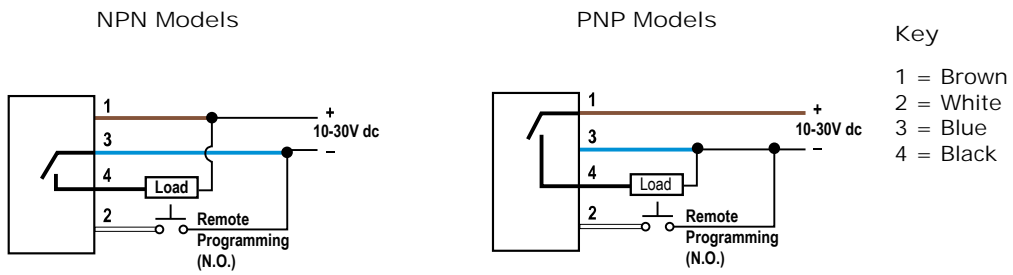

NOTE: Open lead wires must be connected to a terminal block.

4 Operating Instructions

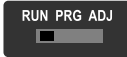

4.1 Run Mode

Run mode allows the sensor to operate normally and prevents unintentional programming changes. The +/SET/- rocker button is disabled during RUN mode, except when using Window SET, see [Window SET](#) on page 17.

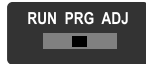

4.2 Program Mode

Program (PRG) mode allows the following settings to be programmed in the DF-G1 (refer to [Figure 3](#) on page 10 and [Figure 5](#) on page 13 for programming).

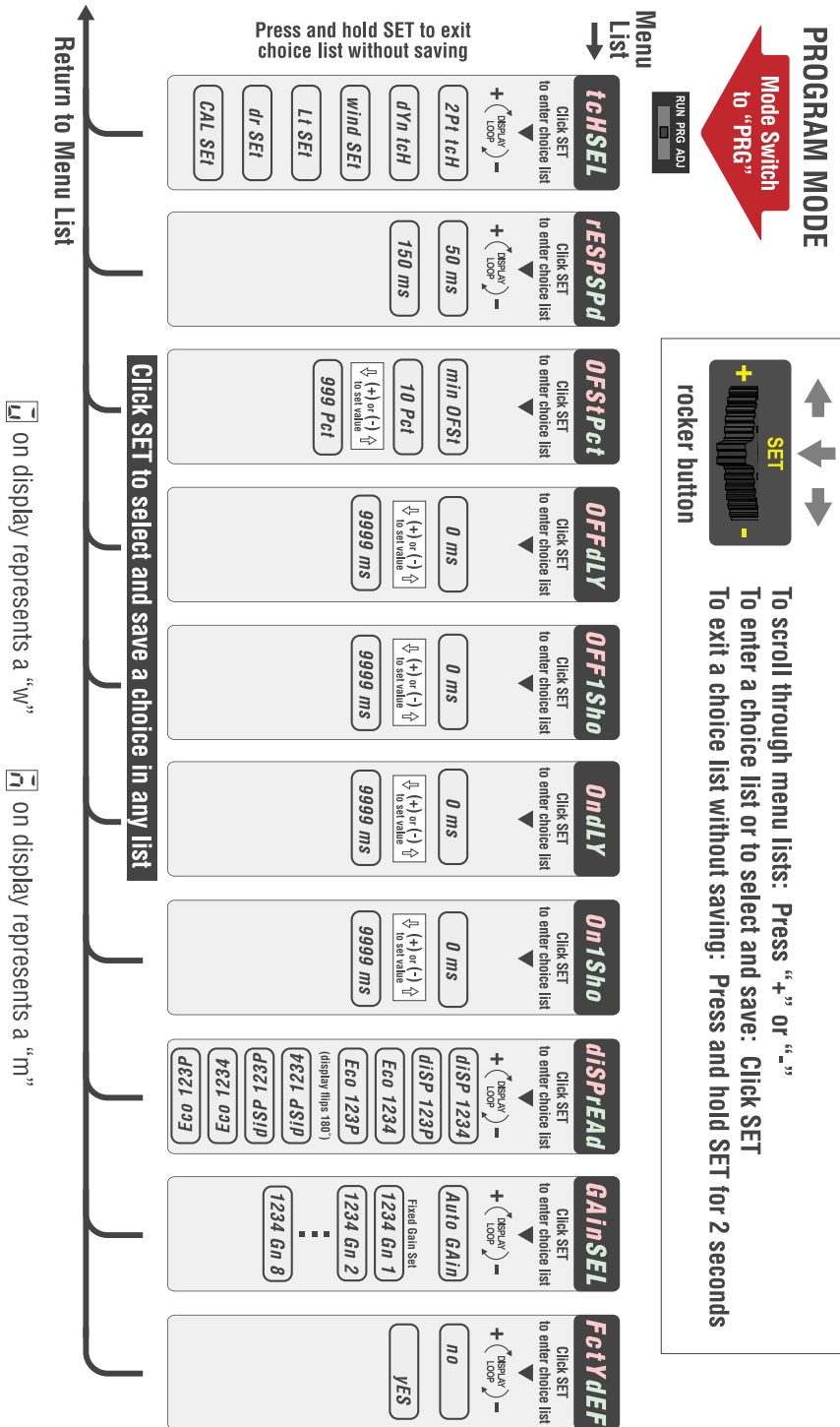

Figure 3.

4.2.1 TEACH Selection tch SEL

The DF-G1 can be programmed for one of the following TEACH/SET methods:

- Two-Point TEACH
- Dynamic TEACH
- Window SET
- Light SET
- Dark SET

- Calibration SET



NOTE: A TEACH Selection must be selected by programming before TEACH/SET methods can be used.

4.2.2 Response Speed RESP SPD

The DF-G1 can be programmed for one of the following Response Speeds:

| Response Speed | Display Range | Crosstalk Avoidance Algorithm |
|----------------|---------------|-------------------------------|
| 50 ms | 0 – 9999 | Disabled |
| 150 ms | 0 – 9999 | Enabled |

4.2.3 Offset Percent OFFSE Pct

The Offset Percent is used during the Window, Light, or Dark SET methods. The threshold(s) are positioned a programmable % offset from the taught condition. The allowable range depends upon the Response Speed Mode, as shown below:

| Response Speed | MIN % | MAX % |
|----------------|-------|-------|
| 50 ms | 10 | 999 |
| 150 ms | 10 | 999 |



The offset percent can also be programmed to Minimum Offset. This allows the DF-G1 to set the threshold(s) as close as possible to the presented condition, but still provide for reliable sensing.



NOTE: Offset Percent MUST be programmed to Minimum Offset for Dark SET to accept conditions of no signal (0 counts).

4.2.4 Delays/Timers OFF dLY OFF 1SHd On dLY On 1SHd

ON/OFF Delays and ON/OFF One-Shot timers can be programmed between 1 - 9999 ms (a value of 0 disables the delay/timer). *Figure 4* on page 11 defines how the delays/timers affect the output behavior.

Some combinations of delays/timers are not allowed. The DF-G1 programming menu automatically disables invalid combinations of delays/timers. When invalid timing functions are attempted, only the last timing function will be implemented. For example, if an Off Delay is selected and then an On One-Shot Timer is added, this invalid combination will force the sensor to have the On One-Shot Timer function and not have the Off Delay. The following table shows the allowable combinations of delays/timers:

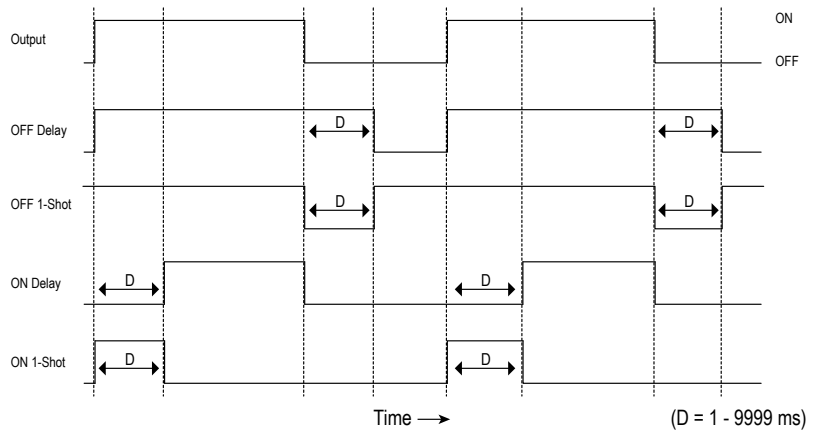

Figure 4. DF-G1 Delays/Timers

| | OFF Delay | OFF One-Shot Timer | ON Delay | ON One-Shot Timer |
|--------------------|-----------|--------------------|----------|-------------------|
| OFF Delay | - | OK | OK | N/A |
| OFF One-Shot Timer | OK | - | N/A | N/A |

| | OFF Delay | OFF One-Shot Timer | ON Delay | ON One-Shot Timer |
|-------------------|-----------|--------------------|----------|-------------------|
| ON Delay | OK | N/A | - | OK |
| ON One-Shot Timer | N/A | N/A | OK | - |

4.2.5 Display Readout

The readout of the digital displays can be programmed for the following options:

- Signal/Threshold readout - Numeric (1234) or % (123P)
- ECO mode - Enabled or Disabled (ECO mode dims the displays to reduce current consumption)
- Display Orientation - Normal (1234) or Flipped (4321)

4.2.6 Gain Selection

The DF-G1 can operate in Auto Gain mode or the Gain can be fixed to be in Gain 1...8. In Auto Gain, the DF-G1 optimizes the gain during a TEACH/SET method for the presented condition(s). While viewing the fixed gains in the Gain Selection choice list, the DF-G1 will automatically switch to the selected gain and display the measured signal on the Red display. This allows for easy and quick evaluation of the fixed gain mode.

4.2.7 Factory Defaults

The Factory Defaults menu allows the DF-G1 to be easily restored back to original factory default settings (see Factory Default Settings in [Specifications](#) on page 25).

4.3 Remote Input

The remote input may be used to perform TEACH/SET methods and to program the sensor remotely. Connect the white input wire of the sensor to ground (0 V dc), with a remote switch connected between them. Pulse the remote input according to the diagram shown in [Figure 5](#) on page 13. Follow the instructions in the TEACH/SET sections in [Adjust Mode](#) on page 13 to perform a TEACH/SET method.

The sensor exits TEACH and remote programming modes after a 60 second timeout. Users may exit TEACH and remote programming modes by setting the remote input low for more than 2 seconds. In either case, the sensor returns to Run mode without saving any new settings.

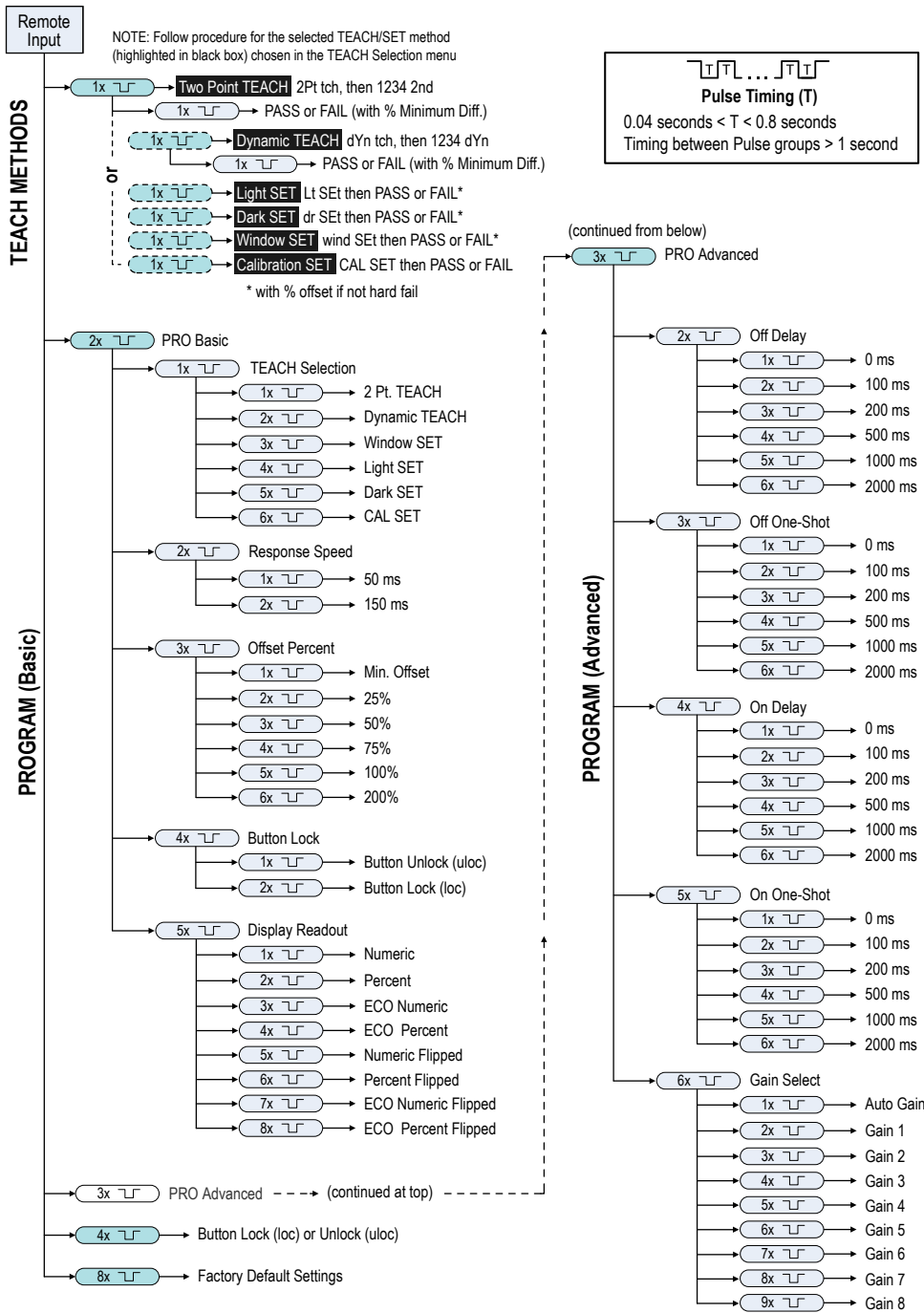

Figure 5. Remote Input Flowchart



4.4 Adjust Mode

Sliding the RUN/PRG/ADJ mode switch to the ADJ position allows the user to perform Expert TEACH/SET methods and Manual Adjustment of the threshold(s).

4.4.1 Two-Point TEACH

- Establishes a single switching threshold
- Threshold can be adjusted by using the "+" and "-" rocker button (Manual Adjust)

Two-Point TEACH is used when two conditions can be presented statically to the sensor. The sensor locates a single sensing threshold (the switch point) midway between the two taught conditions, with the Output ON condition on one side, and the Output OFF condition on the other.

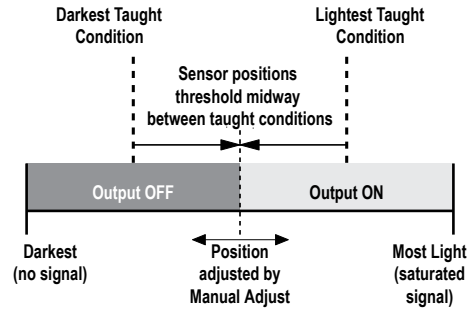

Figure 6. Two-Point TEACH (Light Operate shown)

The Output ON and OFF conditions can be reversed by using the LO/DO (Light Operate/ Dark Operate) switch.

Two-Point TEACH and Manual Adjust

Moves switching threshold value up or down to make adjustments

- Slide Mode switch to ADJ to enter Adjust mode
- Press "+" to increase; press "-" to decrease
 - GREEN display shows the switching threshold value
 - 2 seconds after adjustment, the GREEN display will flash 3 times to confirm
- Slide Mode switch to RUN to complete operation

Follow these steps to perform a Two-Point TEACH:



Note: TEACH Selection must be programmed to 2Pt tch.

1. Enter Adjust mode.



| Method | Action | Result |
|---------------------------|---|--|
| SET Button ² | Set the Mode switch to ADJ. | Display: Red - Signal Level; Green - Threshold |
| Remote Input ³ | No action is required; sensor is ready for the Two-Point TEACH method | |

2. Teach the first condition.

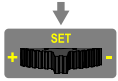

| Method | Action | Result |
|--------------|--|---|
| SET Button | a. Present the first condition. b. Click the SET rocker button. | Display: Flashes "2Pt tch" then holds on "1234 2nd" |
| Remote Input | a. Present the first condition. b. Single-pulse the remote input. | |

3. Teach the second condition.

² SET Button: 0.04 seconds ≤ "Click" ≤ 0.8 seconds
³ Remote Input: 0.04 seconds ≤ T ≤ 0.8 seconds

| Method | Action | Result |
|--------------|---|---|
| SET Button | a. Present the second condition. b. Click the SET rocker button. |  |
| Remote Input | a. Present the second condition. b. Single-pulse the remote input. | |
| | | <p><u>TEACH Accepted</u></p> <p>Displays alternate "PASS" and % Minimum Difference⁴; Sensor returns to Adjust mode</p>  <p><u>TEACH Not Accepted</u></p> <p>Displays alternate "FAIL" and % Minimum Difference⁴; Sensor returns to Adjust mode</p>  |

4. Return to Run mode.

| Method | Action | Result |
|--------------|---|---|
| SET Button | Move the Mode switch to RUN |  |
| Remote Input | No action is required; sensor returns to RUN mode automatically | |
| | | <p>Display: Red - Signal Level; Green - Threshold</p>  |

4.4.2 Dynamic TEACH

- Teaches on-the-fly
- Establishes a single switching threshold
- Threshold can be adjusted using "+" and "-" rocker button (Manual Adjust)

Dynamic TEACH is best used when a machine or process may not be stopped for teaching. The sensor learns during actual sensing conditions, taking multiple samples of the light and dark conditions and automatically setting the threshold at the optimum level.

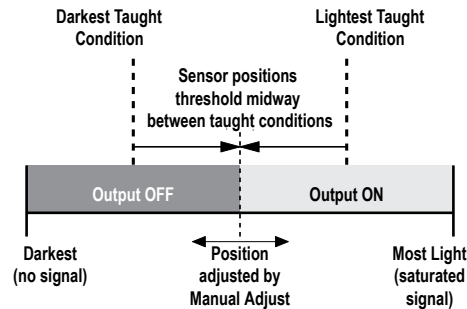

Figure 7. Dynamic TEACH (Light Operate shown)

The output ON and OFF conditions can be reversed using the LO/DO switch.

Dynamic TEACH and Manual Adjust

Moves switching threshold value up or down to make adjustments

- Slide Mode switch to ADJ to enter Adjust mode

⁴ See [Troubleshooting](#) on page 24 for more explanation of the % Minimum Difference displayed after the Two-Point TEACH method.



- Press "+" to increase; press "-" to decrease
 - GREEN display shows the switching threshold value
 - 2 seconds after adjustment, GREEN display will flash 3 times to confirm
- Slide Mode switch to RUN to complete operation

Follow these steps to perform Dynamic TEACH:







NOTE: TEACH Selection must be programmed to dYn tch.

1. Enter Adjust Mode.

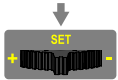
| Method | Action | Result |
|---------------------------|---|---|
| SET Button ⁵ | Set Mode switch to ADJ  | Display: Red - Signal Level; Green - Threshold |
| Remote Input ⁶ | No action required; sensor is ready for Dynamic TEACH method |  |

2. Enter Dynamic TEACH.

| Method | Action | Result |
|--------------|--|--|
| SET Button | Click the SET rocker button  | Display: Flashes "dYn tch" then holds on "1234 dYn" |
| Remote Input | Single-pulse remote input  |   |





3. Present ON and OFF Conditions.

| Method | Action | Result |
|--------------|-------------------------------|---|
| SET Button | Present ON and OFF conditions | Display: Red - Signal Level; Green - Threshold  |
| Remote Input | Present ON and OFF conditions | |



4. Exit Dynamic TEACH.

⁵ SET Button: 0.04 seconds ≤ "Click" ≤ 0.8 seconds

⁶ Remote Input: 0.04 seconds ≤ T ≤ 0.8 seconds

| Method | Action | Result |
|--------------|--|---|
| SET Button | Click the SET rocker button  | <u>TEACH Accepted</u> Displays alternate "PASS" with % Minimum Difference ⁷ , Sensor returns to Adjust mode |
| Remote Input | Single-pulse remote input  |  <u>TEACH Not Accepted</u> Displays alternate "FAIL" with % Minimum Difference ⁷ , Sensor returns to Adjust mode  |

5. Return to RUN Mode.

| Method | Action | Result |
|--------------|--|---|
| SET Button | Move Mode switch to RUN  | Display: Red - Signal Level; Green - Threshold  |
| Remote Input | No action required; sensor returns to RUN mode automatically | |

4.4.3 Window SET

- Sets window thresholds that extend a programmable % offset above and below the presented condition
- All other conditions (lighter or darker) cause the output to change state
- Sensing window center can be adjusted using "+" and "-" rocker button (Manual Adjust)
- Recommended for applications where a product may not always appear in the same place, or when other signals may appear
- See [Program Mode](#) on page 9 for programming the Offset Percent setting (to increase/decrease the window size)

A single sensing condition is presented, and the sensor positions window thresholds a programmable % offset above and below the presented condition. In LO mode, Window SET designates a sensing window with the Output ON condition inside the window, and the Output OFF conditions outside the window.



NOTE: For Window SET and Light SET, the maximum offset threshold percent is 90%.

⁷ See [Troubleshooting](#) on page 24 for more explanation of the % Minimum Difference displayed after the Dynamic TEACH method.

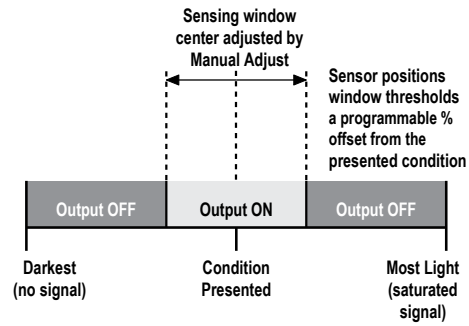

Figure 8. Window SET (Light Operate shown)

Output ON and OFF conditions can be reversed using the LO/DO switch.

Window SET and Manual Adjust

Moves sensing window center value up or down to make adjustments



- Slide Mode switch to ADJ to enter Adjust mode
- Press "+" to increase; press "-" to decrease
 - GREEN display shows the sensing window center value
 - 2 seconds after adjustment, the GREEN display will flash 3 times to confirm
- Slide Mode switch to RUN to complete operation

Follow these steps to perform a Window SET:



Note: TEACH Selection must be programmed to wind SET.

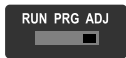



1. Enter Adjust Mode

| Method | Action | Result |
|---------------------------|---|---|
| SET Button ⁸ | Set Mode switch to ADJ  | Display: Red - Signal Level; Green - Threshold |
| Remote Input ⁹ | No action required; sensor is ready for Window SET method |  |



2. SET Sensing Condition

⁸ SET Button: 0.04 seconds ≤ "Click" ≤ 0.8 seconds

⁹ Remote Input: 0.04 seconds ≤ T ≤ 0.8 seconds

| Method | Action | Result |
|--------------|--|---|
| SET Button | <ul style="list-style-type: none"> Present sensing condition Click the SET rocker button  | <p><u>Threshold Condition Accepted</u> Displays read "Wind SET" then alternate "PASS" with % Offset¹⁰; Sensor returns to Adjust mode</p> |
| Remote Input | <ul style="list-style-type: none"> Present sensing condition Single-pulse the remote input  |  <p><u>Threshold Condition Not Accepted</u> Displays read "Wind SET" then alternate "FAIL" with minimum % Offset¹⁰ for sensing condition; Sensor returns to Adjust mode</p>  |

3. Return to RUN Mode

| Method | Action | Result |
|--------------|--|---|
| SET Button | Move Mode switch to Run |  <p>Display: Red - Signal Level; Green - Window Center (see Figure 9 on page 19 for instructions on how to display upper and lower thresholds)</p> |
| Remote Input | No action required; sensor returns to Run mode automatically |  |

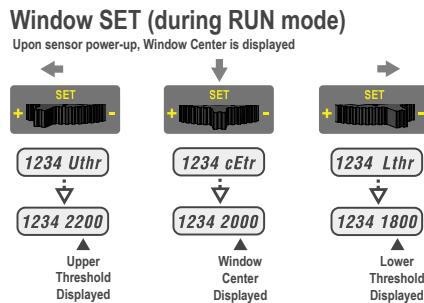

Figure 9. Upper and Lower Thresholds

4.4.4 Light SET

- Sets a threshold a programmable % offset below the presented condition
- Changes output state on any condition darker than the threshold condition
- Threshold can be adjusted using "+" and "-" rocker button (Manual Adjust)
- Recommended for applications where only one condition is known, for example a stable light background with varying darker targets
- See [Program Mode](#) on page 9 for programming the Offset Percent setting

A single sensing condition is presented, and the sensor positions a threshold a programmable % offset below the presented condition. When a condition darker than the threshold is sensed, the output either turns ON or OFF, depending on the LO/DO setting.

¹⁰ See [Troubleshooting](#) on page 24 for more explanation of the % Offset displayed after the Window SET method



NOTE: For Window SET and Light SET, the maximum offset threshold percent is 90%.

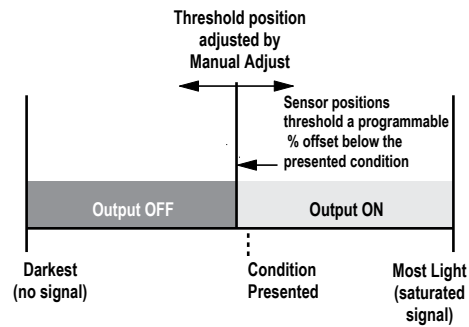

Figure 10. Light SET (Light Operate shown)

Light SET and Manual Adjust

Moves switching threshold value up or down to make adjustments

- Slide Mode switch to ADJ to enter Adjust mode
- Press "+" to increase; press "-" to decrease
 - GREEN display shows the switching threshold value
 - 2 seconds after adjustment, the GREEN display will flash 3 times to confirm
- Slide Mode switch to RUN to complete operation

Follow these steps to perform a Light SET:



Note: TEACH Selection must be programmed to Lt SET.





1. Enter Adjust Mode

| Method | Action | Result |
|----------------------------|---|---|
| SET Button ¹¹ | Set Mode switch to ADJ | Display: Red - Signal Level; Green - Threshold  |
| Remote Input ¹² | No action is required; sensor is ready for Light SET method | |

2. SET Sensing Condition

¹¹ SET Button: 0.04 seconds ≤ "Click" ≤ 0.8 seconds

¹² Remote Input: 0.04 seconds ≤ T ≤ 0.8 seconds

| Method | Action | Result |
|--------------|--|---|
| SET Button | <ul style="list-style-type: none"> Present sensing condition Click the SET rocker button  | <p>Threshold Condition Accepted Displays read "Lt SEt" then alternate "PASS" with % Offset¹³; Sensor returns to Adjust mode</p> |
| Remote Input | <ul style="list-style-type: none"> Present sensing condition Single-pulse the remote input  |  <p>Threshold Condition Not Accepted Displays read "Lt SEt" then alternate "FAIL" with minimum % Offset¹³ for sensing condition; Sensor returns to Adjust mode</p>  |

3. Return to RUN Mode

| Method | Action | Result |
|--------------|--|---|
| SET Button | Move Mode switch to RUN  | Display: Red - Signal Level; Green - Threshold  |
| Remote Input | No action required; sensor returns to RUN mode automatically | |

4.4.5 Dark SET

- Sets a threshold a programmable % offset above the presented condition
- Any condition lighter than the threshold condition causes the output to change state
- Threshold can be adjusted using "+" and "-" rocker button (Manual Adjust)
- Recommended for applications where only one condition is known, for example a stable dark background with varying lighter targets
- See [Program Mode](#) on page 9 for programming the Offset Percent setting



NOTE: Offset Percent MUST be programmed to Minimum Offset to accept conditions of no signal (0 counts).

A single sensing condition is presented, and the sensor positions a threshold a programmable % offset above the presented condition. When a condition lighter than the threshold is sensed, the output either turns ON or OFF, depending on the LO/DO setting.

¹³ See [Troubleshooting](#) on page 24 for more explanation of the % Offset displayed after the Light SET method

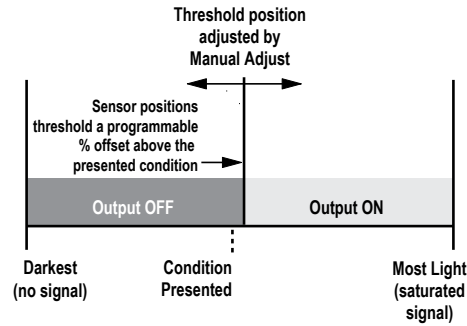

Figure 11. Dark SET (Light Operate shown)

Dark SET and Manual Adjust

Moves switching threshold value up or down to make adjustments



- Slide Mode switch to ADJ to enter Adjust mode
- Press "+" to increase; press "-" to decrease
 - GREEN display shows the switching threshold value
 - 2 seconds after adjustment, the GREEN display will flash 3 times to confirm
- Slide Mode switch to RUN to complete operation

Follow these steps to perform a Dark SET:





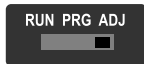

Note: TEACH Selection must be programmed to dr SET.

1. Enter Adjust Mode.

| Method | Action | Result |
|----------------------------|--|---|
| SET Button ¹⁴ | Set Mode switch to ADJ  | Display: Red - Signal Level; Green - Threshold  |
| Remote Input ¹⁵ | No action required; sensor is ready for Dark SET method | |

2. SET Sensing Condition.



| Method | Action | Result |
|--------------|--|---|
| SET Button | <ul style="list-style-type: none"> • Present sensing condition • Click the SET rocker button  | <p><u>Threshold Condition Accepted</u> Displays read "dr SET" then alternate "PASS" with % Offset¹⁶; Sensor returns to Adjust mode</p> |
| Remote Input | <ul style="list-style-type: none"> • Present sensing condition • Single-pulse the remote input  | <p></p> <p><u>Threshold Condition Not Accepted</u> Displays read "dr SET" then alternate "FAIL" with minimum % Offset¹⁶ for sensing condition; Sensor returns to Adjust mode</p> <p></p> |

3. Return to RUN Mode.

¹⁴ SET Button: 0.04 seconds ≤ "Click" ≤ 0.8 seconds

¹⁵ Remote Input: 0.04 seconds ≤ T ≤ 0.8 seconds

¹⁶ See [Troubleshooting](#) on page 24 for more explanation of the % Offset displayed after the Dark SET method

| Method | Action | Result |
|--------------|--|---|
| SET Button | Move Mode switch to RUN  | Display: Red - Signal Level; Green - Threshold  |
| Remote Input | No action required; sensor returns to RUN mode automatically | |

4.4.6 Calibration SET

- Sets a threshold exactly at the presented condition
- Threshold can be adjusted using "+" and "-" rocker button (Manual Adjust)

A single sensing condition is presented, and the sensor positions a threshold exactly at the presented condition. When a condition lighter than the threshold is sensed, the output either turns ON or OFF, depending on the LO/DO setting.

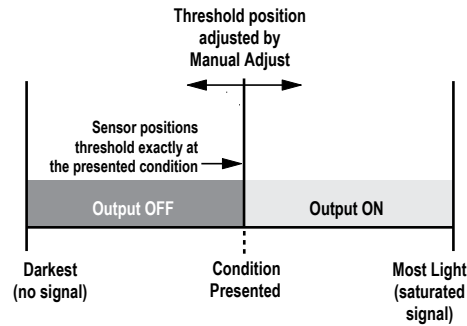

Figure 12. Calibration SET (Light Operate shown)

Calibration SET and Manual Adjust

Moves switching threshold value up or down to make adjustments



- Slide Mode switch to ADJ to enter Adjust mode
- Press "+" to increase; press "-" to decrease
 - GREEN display shows the switching threshold value
 - 2 seconds after adjustment, the GREEN display will flash 3 times to confirm
- Slide Mode switch to RUN to complete operation

Follow these steps to perform a Calibration SET:



Note: TEACH Selection must be programmed to CAL SET.

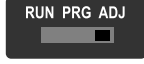





1. Enter Adjust Mode

| Method | Action | Result |
|----------------------------|---|---|
| SET Button ¹⁷ | • Set Mode switch to ADJ  | Display: Red - Signal Level; Green - Threshold  |
| Remote Input ¹⁸ | No action required; sensor is ready for Calibration SET method | |

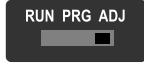

2. SET Sensing Condition

¹⁷ SET Button: 0.04 seconds ≤ "Click" ≤ 0.8 seconds

¹⁸ Remote Input: 0.04 seconds ≤ T ≤ 0.8 seconds

| Method | Action | Result |
|--------------|--|--|
| SET Button | <ul style="list-style-type: none"> Present sensing condition Click the SET rocker button  | Threshold Condition Accepted Displays read "cAL SET" then flashes "PASS"; Sensor returns to Adjust mode |
| Remote Input | <ul style="list-style-type: none"> Present sensing condition Single-pulse the remote input  |   Threshold Condition Unacceptable Displays read "cAL SET" then flashes "FAIL"; Sensor returns to Adjust mode   |

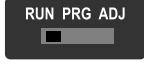
3. Return to RUN Mode

| Method | Action | Result |
|--------------|---|---|
| SET Button | Move Mode switch to RUN  | Display: Red - Signal Level; Green - Threshold  |
| Remote Input | No action required; sensor returns to RUN mode automatically | |

4.4.7 Troubleshooting

Percent Minimum Difference after TEACH

The Two-Point and Dynamic TEACH methods will flash a % minimum difference on the displays after a PASS or FAIL.

| Value | PASS/FAIL | Description |
|-------------|-----------|--|
| 0 to 99% | FAIL | The difference of the taught conditions does not meet the required minimum |
| 100 to 300% | PASS | The difference of the taught conditions just meets/exceeds the required minimum, minor sensing variables may affect sensing reliability |
| 300 to 600% | PASS | The difference of the taught conditions sufficiently exceeds the required minimum, minor sensing variables will not affect sensing reliability |
| 600% + | PASS | The difference of the taught conditions greatly exceeds the required minimum, very stable operation |

Percent Offset after SET

The Window, Dark, and Light SET methods will flash a % offset on the displays after a PASS or FAIL.

| SET Result | % Offset Meaning |
|-------------------------|---|
| PASS (with % Offset) | Displays the % offset used for the SET method |
| FAIL (with % Offset) | Displays the minimum required % offset necessary to PASS the SET method |
| FAIL (without % Offset) | Presented condition cannot be used for the SET method |



NOTE: For Window SET and Light SET, the maximum offset threshold percent is 90%.

5 Specifications

Light Detection Range

400 to 1100 nm

Supply Voltage

10 to 30 V dc Class 2 (10% maximum ripple)

Power and Current Consumption (exclusive of load)

Standard display mode: 960 mW, Current consumption < 40 mA at 24 V dc

ECO display mode: 720 mW, Current consumption < 30 mA at 24 V dc

Supply Protection Circuitry

Protected against reverse polarity and transient overvoltages

Delay at Power-Up

500 milliseconds maximum; outputs do not conduct during this time

Output Configuration

1 current sinking (NPN) or 1 current sourcing (PNP) output, depending on model

Output Rating

100 mA maximum load (derate 1 mA per °C above 30 °C)

OFF-state leakage current: < 5 µA at 30 V dc

ON-state saturation voltage: NPN: < 1.5 V; PNP < 2 V

Output Protection

Protected against output short-circuit, continuous overload, transient overvoltages, and false pulse on power-up

Output Response Time

50 ms

150 ms

Temperature Drift

0.2% per °C

Indicators

Red 4-digit Display: Signal Level

Green 4-digit Display: Threshold

(In Program Mode, Red and Green displays are used for programming menus)

Yellow LED: Output conducting

Required Overcurrent Protection



WARNING: Electrical connections must be made by qualified personnel in accordance with local and national electrical codes and regulations.

Overcurrent protection is required to be provided by end product application per the supplied table.

Overcurrent protection may be provided with external fusing or via Current Limiting, Class 2 Power Supply.

Supply wiring leads < 24 AWG shall not be spliced.

For additional product support, go to <http://www.bannerengineering.com>.

| Supply Wiring | Required Overcurrent Protection |
|---------------|---------------------------------|
| 20 | 5.0 Amps |
| 22 | 3.0 Amps |
| 24 | 2.0 Amps |
| 26 | 1.0 Amps |
| 28 | 0.8 Amps |
| 30 | 0.5 Amps |

Adjustments

3-way RUN/PRG/ADJ Mode Switch

2-way LO/DO Switch

3-way +/SET/- Rocker Button

- Expert-style teaching (Two-Point and Dynamic TEACH, Light/Dark/Window/Calibration SET)
- Manually adjust sensitivity (from "+" and "-" rocker button only)
- Response Speed, TEACH Selection, Offset Percent, Delays/Timers, Display Readout, Gain Selection, Factory Defaults (from top panel or remote input)
- Top panel interface lockout (from remote input only)

Factory Default Settings:

| Setting | Factory Default |
|-----------------|---|
| Threshold | 5000 |
| TEACH Selection | Two-Point TEACH |
| Response Speed | 50 ms |
| Offset Percent | 50% |
| OFF Delay | 0 (Disabled) |
| OFF One-Shot | 0 (Disabled) |
| ON Delay | 0 (Disabled) |
| ON One-Shot | 0 (Disabled) |
| Display Readout | Numeric, ECO disabled, Normal Orientation |
| Gain Selection | Auto Gain |

Connections

PVC-jacketed 2 m or 9 m (6.5 ft. or 30 ft.) 4-wire integral cable; or integral 4-pin M8/Pico-style quick disconnect; or 150 mm (6 in.) cable with a 4-pin M12/Euro-style quick disconnect; or 150 mm (6 in.) cable with a 4-pin M8/Pico-style quick disconnect.

Construction

Black ABS/polycarbonate alloy (UL94 V-0 rated) housing, clear polycarbonate cover

Environmental Rating

IEC IP50, NEMA 1

Operating Conditions

Temperature: -10 °C to +55 °C (+14 °F to +131 °F)

Storage Temperature: -20 °C to +85 °C (-4 °F to +185 °F)

Humidity: 90% at +60 °C maximum relative humidity (non-condensing)

Certifications



5.1 Dimensions

All measurements are listed in millimeters (inches), unless noted otherwise.

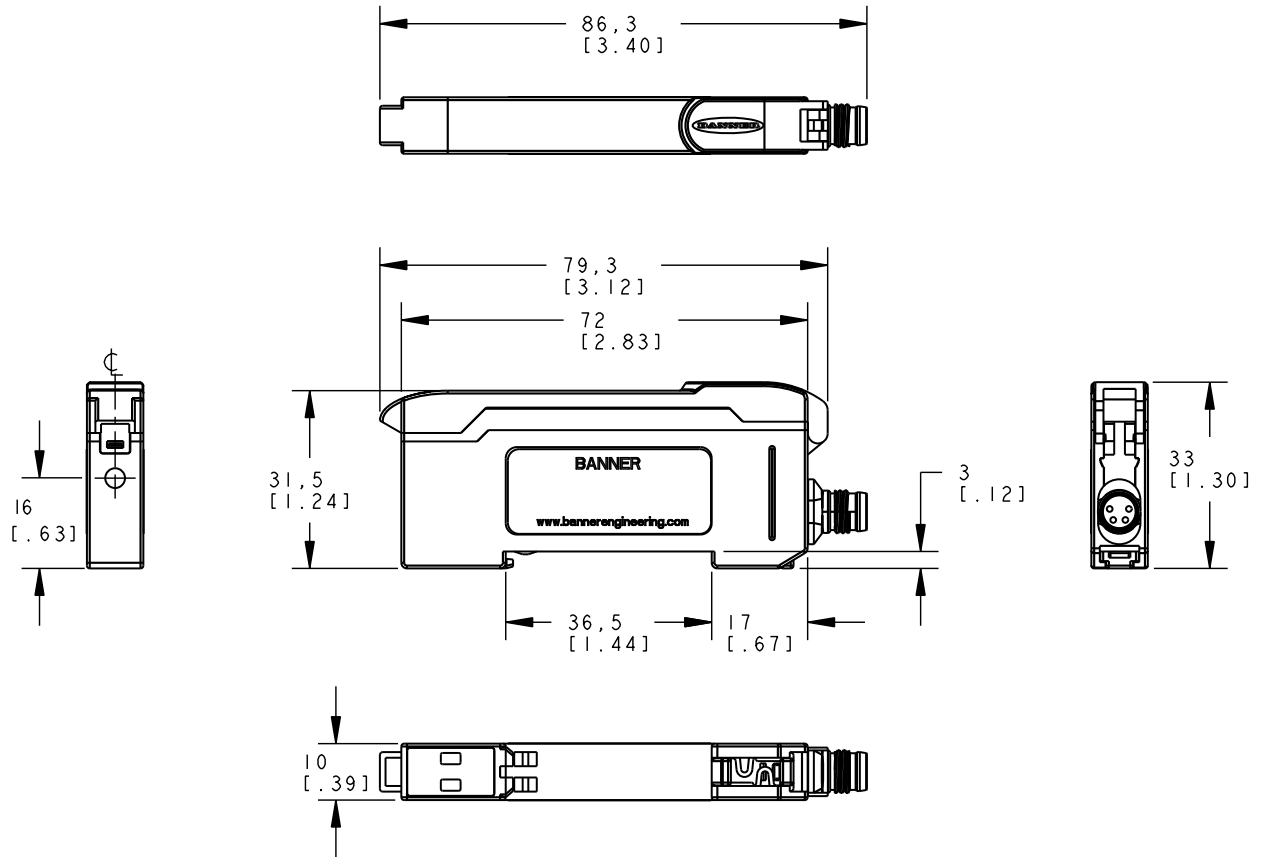

6 Accessories

DIN-35-..

35 mm DIN Rail

| Model | Length |
|------------|--------|
| DIN-35-70 | 70 |
| DIN-35-105 | 105 |
| DIN-35-140 | 140 |

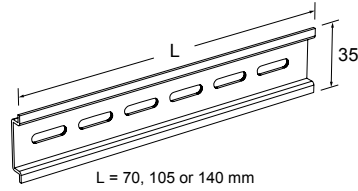

Hole center spacing: 35.1

Hole size: 25.4 x 5.3

SA-DIN-CLAMP

- Pair of metal DIN rail end stops; slide onto DIN rail at either side of the sensor stack
- Combination (#2 Phillips, #8 standard slotted) set screw

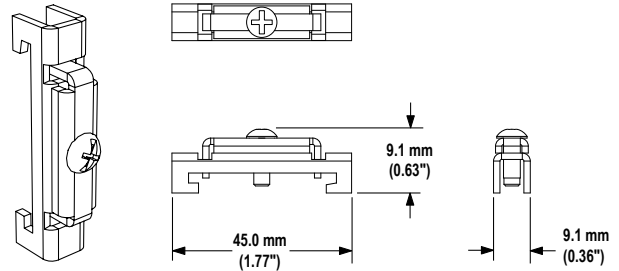

SA-DIN-BRACKET

- Plastic bracket with mounting screws

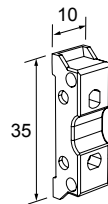

Hole center spacing: A = 16, B = 25.4, C = 15.2

Hole size: A = \varnothing 3.2, B = \varnothing 3.3, C = \varnothing 4.4

SA-DIN-BRACKET-10

- Package of 10 plastic brackets with mounting screws

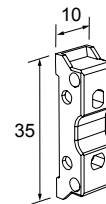

Hole center spacing: A = 16, B = 25.4, C = 15.2

Hole size: A = \varnothing 3.2, B = \varnothing 3.3, C = \varnothing 4.4

6.1 Quick-Disconnect Cordsets

All measurements are listed in millimeters, unless noted otherwise.

| 4-Pin Threaded M12/Euro-Style Cordsets | | | | |
|--|----------------|-------------|------------|---|
| Model | Length | Style | Dimensions | Pinout (Female) |
| MQDC-406 | 1.83 m (6 ft) | Straight | | <p>1 = Brown 2 = White 3 = Blue 4 = Black</p> |
| MQDC-415 | 4.57 m (15 ft) | | | |
| MQDC-430 | 9.14 m (30 ft) | | | |
| MQDC-450 | 15.2 m (50 ft) | | | |
| MQDC-406RA | 1.83 m (6 ft) | Right-Angle | | |
| MQDC-415RA | 4.57 m (15 ft) | | | |
| MQDC-430RA | 9.14 m (30 ft) | | | |
| MQDC-450RA | 15.2 m (50 ft) | | | |

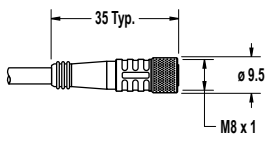
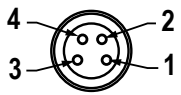
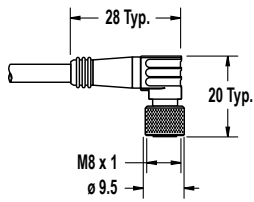
| 4-Pin Threaded M8/Pico-Style Cordsets | | | | |
|---------------------------------------|---------------|-------------|--|---|
| Model | Length | Style | Dimensions | Pinout (Female) |
| PKG4M-2 | 2 m (6.56 ft) | Straight |  |  <p>1 = Brown 2 = White 3 = Blue 4 = Black</p> |
| PKG4M-5 | 5 m (16.4 ft) | | | |
| PKG4M-9 | 9 m (29.5 ft) | | | |
| PKW4M-2 | 2 m (6.56 ft) | Right Angle |  | |
| PKW4M-5 | 5 m (16.4 ft) | | | |
| PKW4M-9 | 9 m (29.5 ft) | | | |

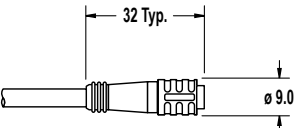
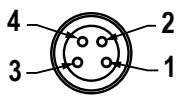
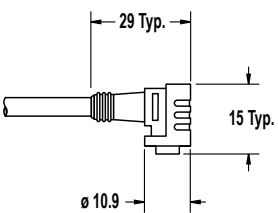
| 4-Pin Snap-on M8/Pico-Style Cordsets | | | | |
|--------------------------------------|----------------|-------------|---|--|
| Model | Length | Style | Dimensions | Pinout (Female) |
| PKG4-2 | 2 m (6.6 ft) | Straight |  |  <p>1 = Brown 2 = White 3 = Blue 4 = Black</p> |
| PKG4-5 | 5 m (16.4 ft) | | | |
| PKG4-10 | 10 m (32.8 ft) | | | |
| PKW4Z-2 | 2 m (6.6 ft) | Right-Angle |  | |
| PKW4Z-5 | 5 m (16.4 ft) | | | |

7 Banner Engineering Corp Limited Warranty

Banner Engineering Corp. warrants its products to be free from defects in material and workmanship for one year following the date of shipment. Banner Engineering Corp. will repair or replace, free of charge, any product of its manufacture which, at the time it is returned to the factory, is found to have been defective during the warranty period. This warranty does not cover damage or liability for misuse, abuse, or the improper application or installation of the Banner product.

THIS LIMITED WARRANTY IS EXCLUSIVE AND IN LIEU OF ALL OTHER WARRANTIES WHETHER EXPRESS OR IMPLIED (INCLUDING, WITHOUT LIMITATION, ANY WARRANTY OF MERCHANTABILITY OR FITNESS FOR A PARTICULAR PURPOSE), AND WHETHER ARISING UNDER COURSE OF PERFORMANCE, COURSE OF DEALING OR TRADE USAGE.

This Warranty is exclusive and limited to repair or, at the discretion of Banner Engineering Corp., replacement. IN NO EVENT SHALL BANNER ENGINEERING CORP. BE LIABLE TO BUYER OR ANY OTHER PERSON OR ENTITY FOR ANY EXTRA COSTS, EXPENSES, LOSSES, LOSS OF PROFITS, OR ANY INCIDENTAL, CONSEQUENTIAL OR SPECIAL DAMAGES RESULTING FROM ANY PRODUCT DEFECT OR FROM THE USE OR INABILITY TO USE THE PRODUCT, WHETHER ARISING IN CONTRACT OR WARRANTY, STATUTE, TORT, STRICT LIABILITY, NEGLIGENCE, OR OTHERWISE.

Banner Engineering Corp. reserves the right to change, modify or improve the design of the product without assuming any obligations or liabilities relating to any product previously manufactured by Banner Engineering Corp.