



microQSFP Pluggable Passive Copper Cable Assemblies

TABLE OF CONTENTS

Introduction.....	2
Description.....	2
Features and Benefits.....	2
Product Applications.....	2
Industry Standards.....	2
Technical Documents.....	2
Part Numbers.....	3
Table 1. Part Number Selection Guide.....	3
Product Specifications.....	3
Table 2. Material Specifications.....	3
Table 3. Electrical/Mechanical Specifications.....	3
Table 4. Environmental Specifications.....	4
Table 5. Bulk Cable Specifications.....	4
Table 6. Operating Specifications.....	4
Pin Configurations.....	5
microQSFP Straight Cable Assembly.....	5
microQSFP to 2x microQSFP Breakout Assembly.....	6
microQSFP to QSFP28 Hybrid Assembly.....	7
microQSFP to 4x SFP28 Breakout Assembly.....	8
ASHREA.....	8
Guidelines.....	8
Plot.....	9
microqsfp Cable Assembly Mechanical Schematics.....	10
microQSFP Straight Cable Assembly.....	10
microQSFP to 2x microQSFP Breakout Assembly.....	10
microQSFP to QSFP28 Hybrid Assembly.....	10
microQSFP to 4x SFP28 Breakout Assembly.....	10
EEPROM Memory Map.....	11
Description of Memory Map and Control Functions.....	11
Table 7. Lower Memory Map.....	11
Table 8. Upper Memory Map 00h.....	12
Signal Integrity Performance.....	13
QSFP28 to QSFP28 DAC Signal Integrity Performance Plots.....	13

microQSFP Pluggable Passive Copper Cable Assemblies

INTRODUCTION

Description

TE Connectivity's (TE) microQSFP passive copper cable assembly is a high density 4x28G solution that provides 33% higher density than existing form factors such as QSFP. microQSFP cables feature eight differential copper pairs and four 28G data transmission channels in a SFP-sized form factor. This type of density allows more ports (up to 72) on a standard line card, saving significant design space. A Multi-Source Agreement (MSA) defines the mechanical features of the cable plug, receptacle connector and cage to provide a standard interface. The microQSFP copper cable assembly is compatible with 25G/100G Ethernet, 25G/50G Ethernet Consortium and InfiniBand Enhanced Data Rate (EDR) electrical performance requirements.

Offered in a broad range of wire gages – from 28AWG through 32AWG – this 28G copper cable assembly features low insertion loss and low cross talk. The cable plug incorporates cooling fins to enhance thermal performance in order to keep energy costs low and maximize reliability.

Designed for 28G applications in the data center, networking and telecommunications markets that require a high density, high speed, reliable cable assembly. The MSA standardized form factor supports next generation 56G performance and ensures backwards compatibility to 28G.

Features and Benefits

- Compatible with 25G/100G Ethernet, 25G/50G Ethernet Consortium and InfiniBand EDR
- Supports aggregate data rates of 100Gbps in SFP sized form factor
- One-third more dense than existing QSFP form factor
- Cooling fins integrated into cable plug module enhances thermal management
- Optimized construction to minimize insertion loss and cross talk
- Customized cable braid termination limits EMI radiation
- Straight, breakout and hybrid assembly configurations available
- Pull-to-release spring latch design
- 28AWG through 32AWG cable
- RoHS compliant

Product Applications

- Switches, servers and routers
- Data Center networks
- Storage area networks
- High performance computing
- Telecommunication and wireless infrastructure

Industry Standards

- μ QSFP Multi-Source Agreement (MSA)
- 25G/100G Ethernet
- 25G/50G Ethernet Consortium
- InfiniBand EDR

Technical Documents

Product Specification

108-32124 microQSFP Copper Module Direct Attach Cable Assembly

microQSFP Pluggable Passive Copper Cable Assemblies

PART NUMBERS

Table 1. Part Number Selection Guide

TEPN	Description	AWG	Cable Assembly Length (meters)				
			0.5	1	2	3	4
2821236	microQSFP to microQSFP Cable Assembly	32	-1	-2	-3		
2821310		30	-1	-2	-3	-4	
2821313		28	-1	-2	-3	-4	-5
2821644	microQSFP to (4x) SFP28 Breakout Assembly	32	-1	-2	-3		
2821635		30	-1	-2	-3	-4	
2821645		28	-1	-2	-3	-4	-5
2821779	microQSFP to QSFP28 Cable Assembly	32	-1	-2	-3		
2821781		30	-1	-2	-3	-4	
2821782		28	-1	-2	-3	-4	-5
2821783	microQSFP to (2x) microQSFP Breakout Assembly	32	-1	-2	-3		
2821784		30	-1	-2	-3	-4	
2821785		28	-1	-2	-3	-4	-5

Contact TE for customized lengths.

PRODUCT SPECIFICATIONS

Table 2. Material Specifications

PCB	Halogen Free low loss laminate
	IPC Class 3
Contact	30µin min hard Gold plated contact pads
Backshell	Nickel plated zinc diecast
Latch Spring	Stainless steel
Pull Tab	Molded santoprene
Bulk Cable	Silver plated copper conductor
	Metallized shielding tape
	Flexible PVC jacket

Table 3. Electrical/Mechanical Specifications

Impedance	100Ω
Data Rate	Up to 28Gb/s NRZ
Durability	200 cycles
Mating Force	40N mating force maximum

microQSFP Pluggable Passive Copper Cable Assemblies

Table 4. Environmental Specifications

Rated Temperature	80°C
Flammability Rating	VW-1
Safety Certifications	RoHS compliant
	REACH compliant

Table 5. Bulk Cable Specifications

8-pair Bend Radius	32AWG= 31 mm
	30AWG= 37 mm
	28AWG= 43 mm
4-pair Bend Radius	32AWG= 25 mm
	30AWG= 25 mm
	28AWG= 31 mm
2-pair Bend Radius	32AWG= 19 mm
	30AWG= 25 mm
	28AWG= 25 mm
8 pair Cable OD	32AWG= 6.2 mm
	30AWG= 6.9 mm
	28AWG= 8.38 mm
4 pair Cable OD	32AWG= 4.5 mm
	30AWG= 5.6 mm
	28AWG= 6.4 mm
2 pair Cable OD	32AWG= 4.2 mm
	30AWG= 4.6 mm
	28AWG= 4.95 mm
Attenuation at 12.89 GH	32AWG= 6.53 dB/m
	30AWG= 5.5 dB/m
	28AWG= 4.25 dB/m

Table 6. Operating Specifications

Parameter	Min	Nominal	Max	Unit
Operating Voltage	3.13	3.3	3.46	V
Two-Wire SCL Frequency			400	kHz
Passive microQSFP Power (per connector)	4.7	5.1	11	mW
Operating Data Rate	0.01		28	Gbps

microQSFP Pluggable Passive Copper Cable Assemblies

PIN CONFIGURATIONS

microQSFP Straight Cable Assembly

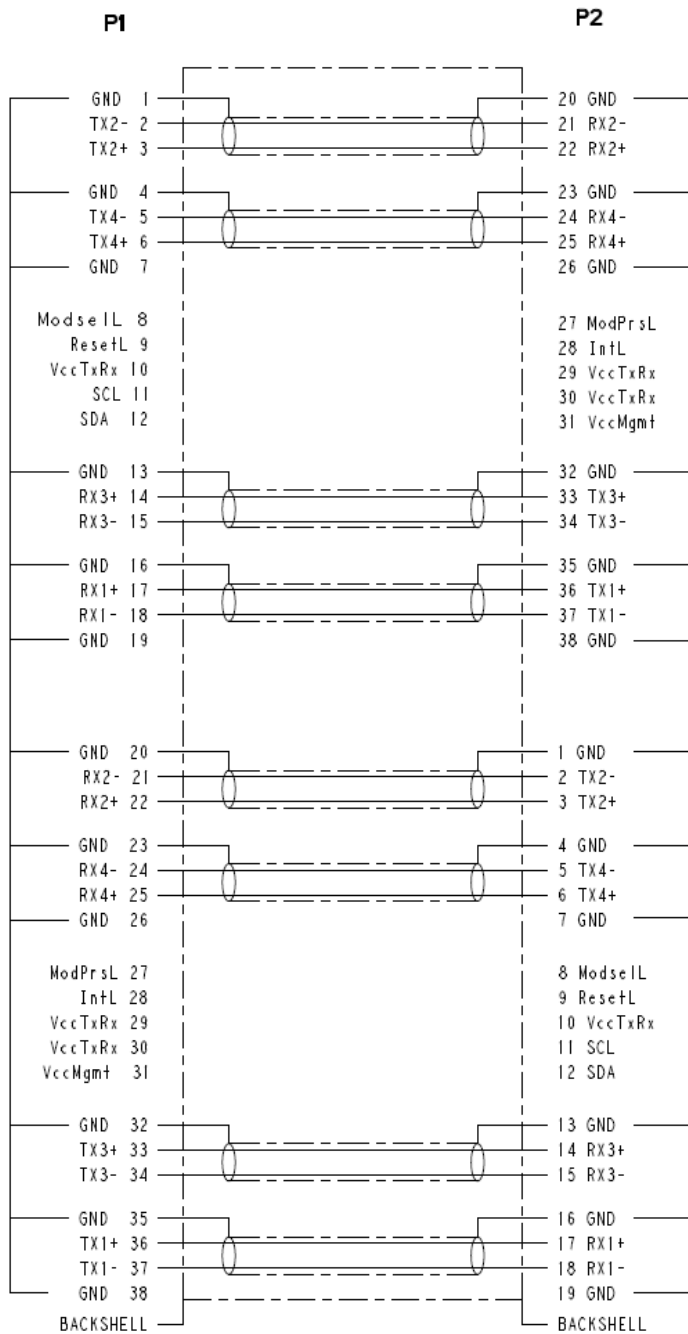

microQSFP Pluggable Passive Copper Cable Assemblies

microQSFP to 2x microQSFP Breakout Assembly

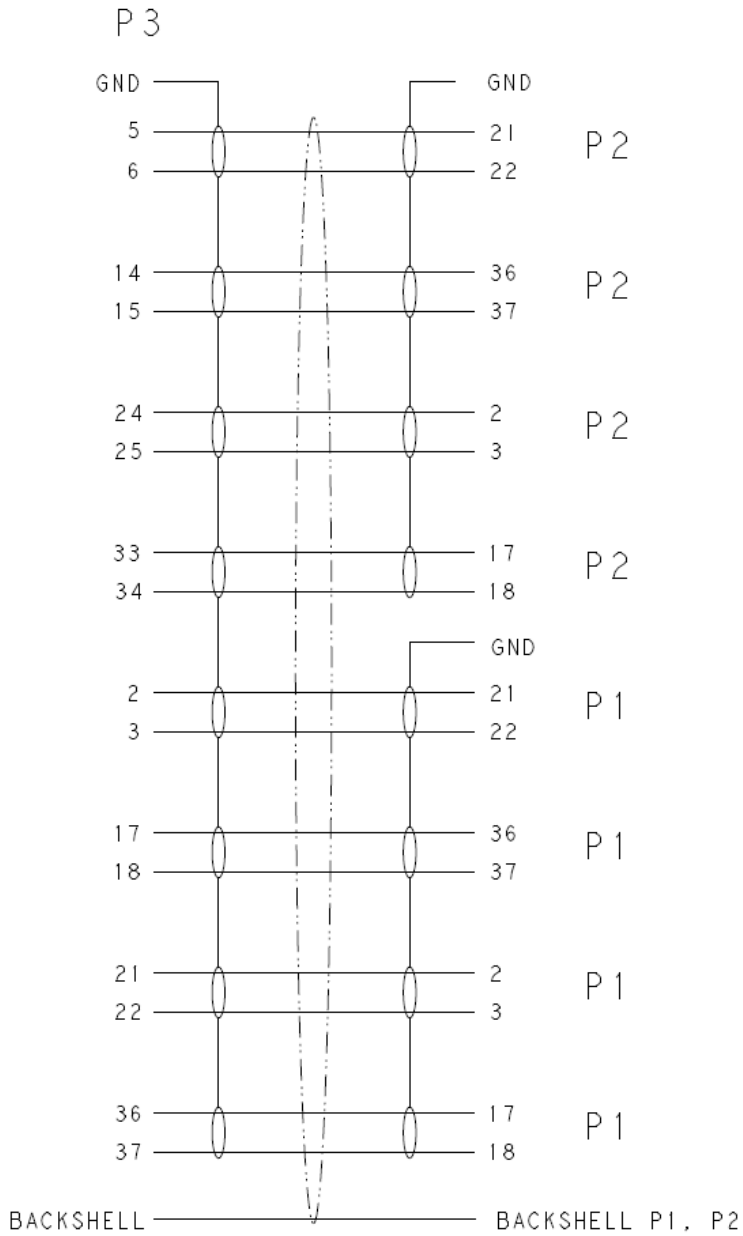

microQSFP Pluggable Passive Copper Cable Assemblies

microQSFP to QSFP28 Hybrid Assembly

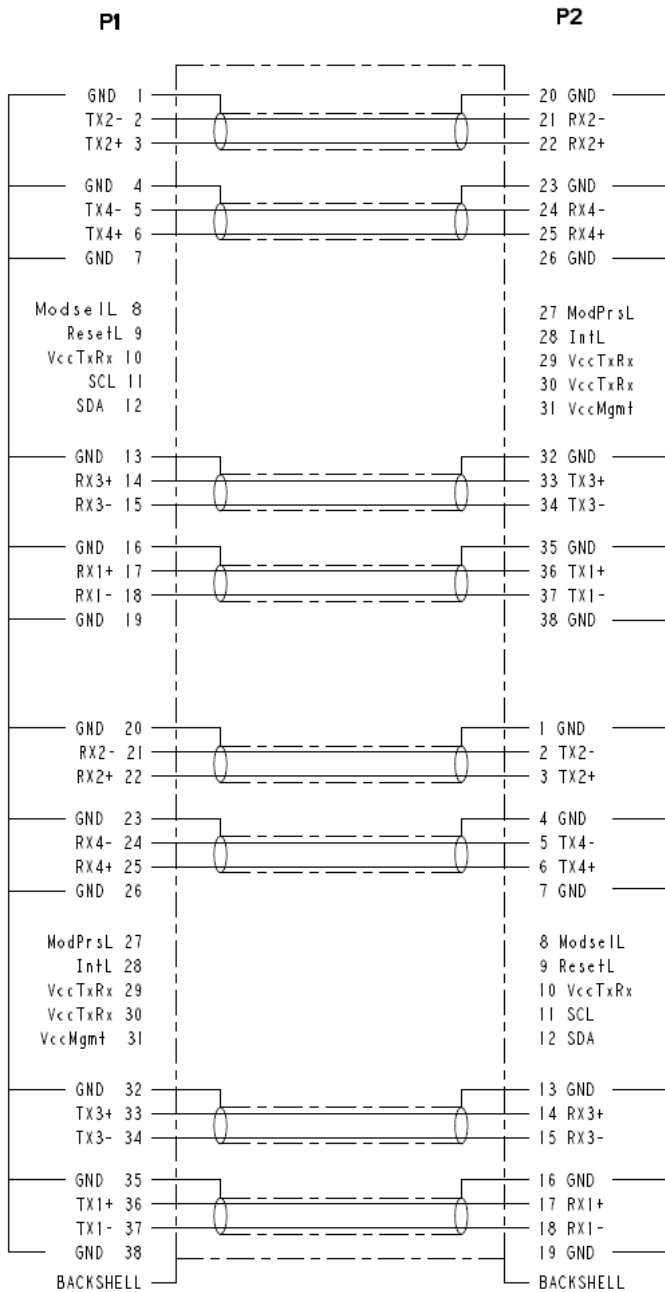

microQSFP Pluggable Passive Copper Cable Assemblies

microQSFP to 4x SFP28 Breakout Assembly

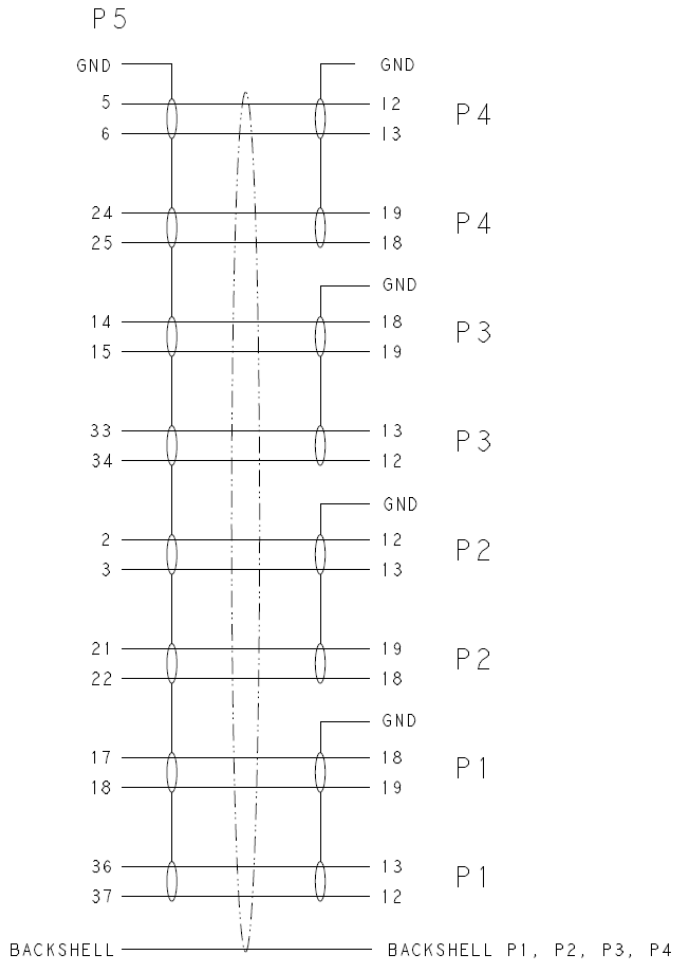

ASHREA

Guidelines

ASHRAE stands for the American Society of Heating, Refrigerating, and Air-Conditioning Engineers. Founded in 1894, it is a global society advancing human well-being through sustainable technology for the built environment. ASHRAE focuses on building systems, energy efficiency, indoor air quality, refrigeration and sustainability.

ASHRAE publishes a well-recognized series of standards and guidelines relating to HVAC systems and issues. These standards are often referenced in building codes, and are considered useful standards for use by consulting engineers, mechanical contractors, architects, and government agencies. These building codes are commonly accepted standards for architects and engineers.

ASHRAE Technical Committee 9.9, Mission Critical Facilities, Technology Spaces and Electronic Equipment, brings together the interests of the data center industry in the area of data center cooling technologies. ASHRAE developed the Thermal Guidelines for Data Processing Environments that establishes a framework for cooling requirements in the data center. These Guidelines define four classes of data center equipment (A1 through A4) based on the equipment's operating temperature and relative humidity requirements.

microQSFP Pluggable Passive Copper Cable Assemblies

The ASHRAE recommended A1 range defines the range where the most reliable and power efficient operation of the data center can be achieved based on ITE manufacturers' input. The ASHRAE A4 range (free cooling) is the broadest range in terms of temperature and relative humidity extremes.

TE tested 25G bulk cable at max and min recommended operating temperatures and plotted the results versus ASHRAE A1 and A4 classes. At both extreme temperatures, TE bulk cable exceeds ASHRAE recommended guidelines at the free cooling A4 range.

Plot

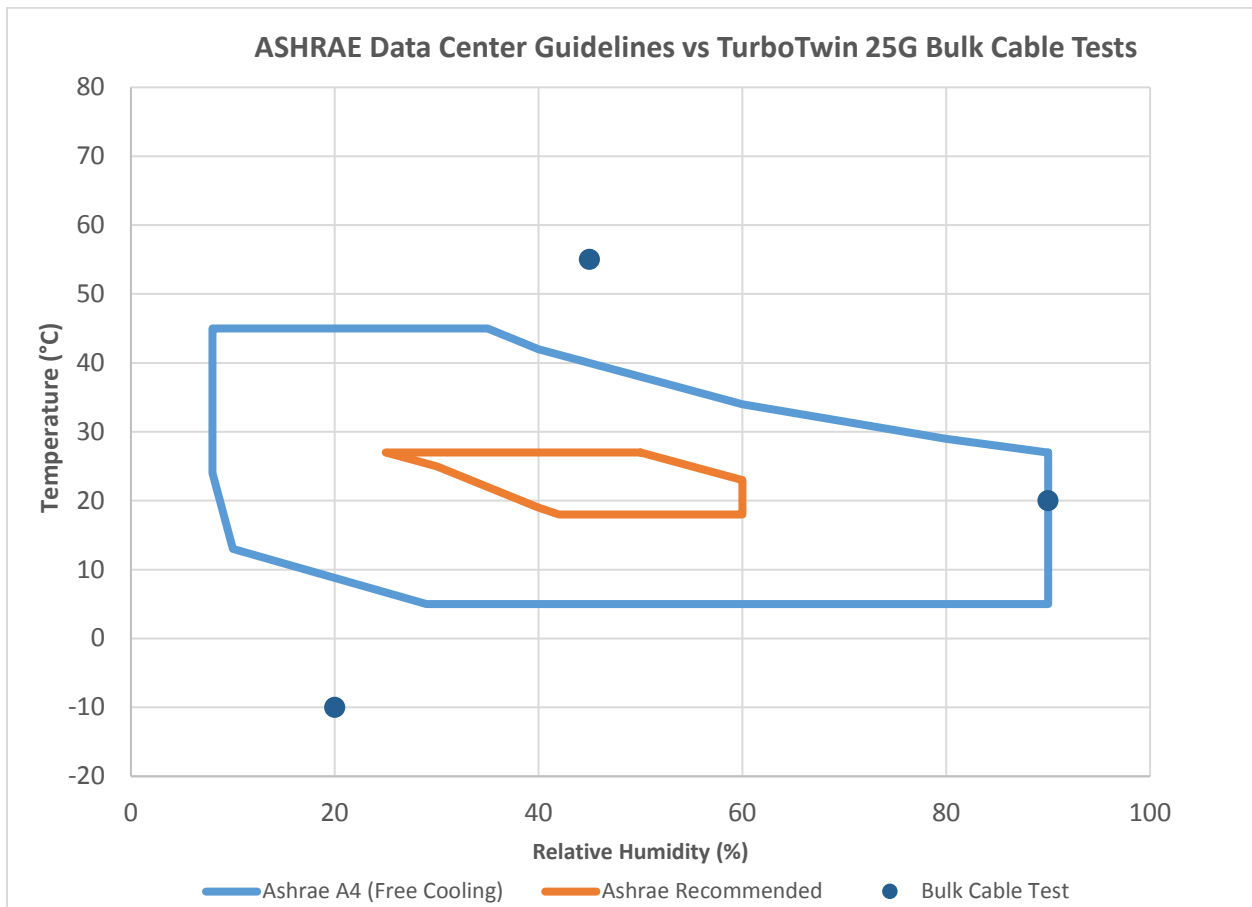

microQSFP Pluggable Passive Copper Cable Assemblies

microQSFP CABLE ASSEMBLY MECHANICAL SCHEMATICS

microQSFP Straight Cable Assembly

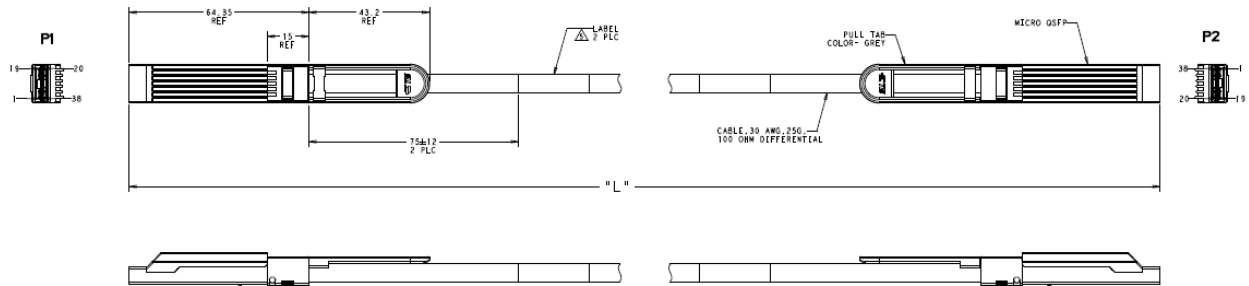

microQSFP to 2x microQSFP Breakout Assembly

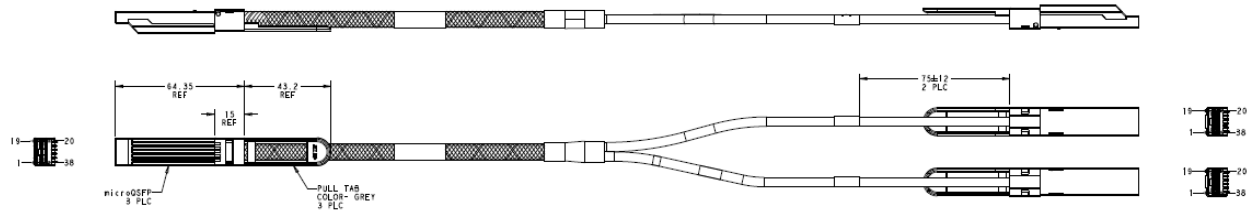

microQSFP to QSFP28 Hybrid Assembly

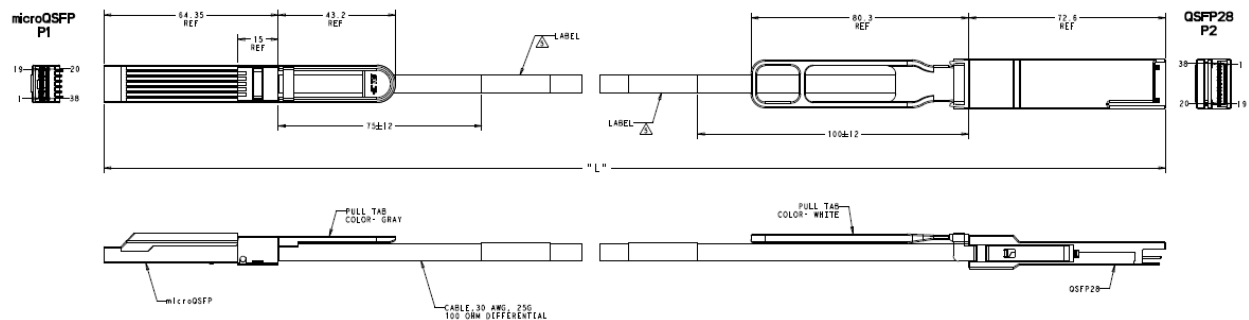

microQSFP to 4x SFP28 Breakout Assembly

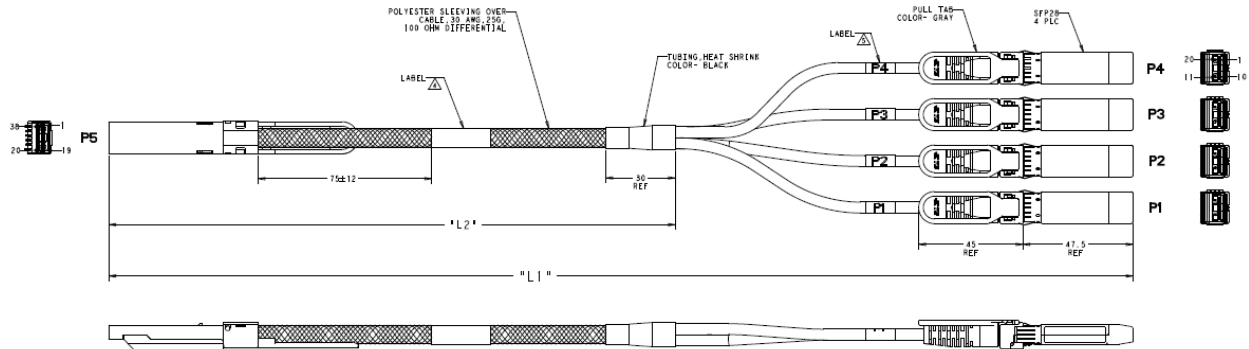

microQSFP Pluggable Passive Copper Cable Assemblies

EEPROM MEMORY MAP

Description of Memory Map and Control Functions

TE's microQSFP cables utilize EEPROM mapping protocol defined by SFF-8636 (QSFP28). The lower 128 bytes of A0h of the 2-wire serial bus address space, Table 7, is used to access a variety of measurements and diagnostic functions, a set of control functions, and a means to select which of the various upper memory map pages are accessed on subsequent reads. This portion of the address space is always directly addressable and thus chosen for monitoring and control functions that may need to be repeatedly accessed. Table 8 shows the upper 128 byte address space 00h.

Table 7. Lower Memory Map

Byte Address	Description	Description
0	Identifier (1 Byte)	Identifier (1 Byte)
1	Revision Compliance	Revision Compliance
2	Status	Status
3-21	Interrupt Flags (19 Bytes)	Interrupt Flags (19 Bytes)
22-33	Module Monitors (12 Bytes)	Module Monitors (12 Bytes)
34-81	Channel Monitors (48 Bytes)	Channel Monitors (48 Bytes)
82-85	Reserved (4 Bytes)	Reserved (4 Bytes)
86-97	Control (12 Bytes)	Control (12 Bytes)
98-99	Reserved (4 Bytes)	Reserved (4 Bytes)
100-106	Module and Channel Masks (7 Bytes)	Module and Channel Masks (7 Bytes)
107-118	Reserved (12 Bytes)	Reserved (12 Bytes)
119-122	Reserved (4 Bytes)	Reserved (4 Bytes)
123-126	Reserved (4 Bytes)	Reserved (4 Bytes)
127	Page Select Byte	Page Select Byte

microQSFP Pluggable Passive Copper Cable Assemblies

Table 8. Upper Memory Map 00h

Byte Address	Name	Description
128	Identifier (1 Byte)	Identifier type of serial transceiver
129	Ext. Identifier (1 Byte)	Extended identifier of serial transceiver
130	Connector (1 Byte)	Code for connector type
131-138	Transceiver (8 Bytes)	Code for electronic or optical comp ability
139	Encoding (1 Byte)	Code for serial encoding algorithm
140	BR nominal (1 Byte)	Nominal bit rate units of 100 Mbps
141	Ext. Rate Sel Comp (1 Byte)	Tags for extended rate select compliance
142	Length SMF (1 Byte)	Link length supported for SM fiber in km
143	Length E-50um (1 Byte)	Link length supported for EBW 50/125um fiber units of 2m
144	Length 50um (1 Byte)	Link length supported for 50/125um fiber units of 1m
145	Length 62.5um (1 Byte)	Link length supported for 62.5/125um fiber units of 1m
146	Length Copper (1 Byte)	Link length supported copper units of 1m
147	Device Technology (1 Byte)	Device technology
148-163	Vendor Name (16 Bytes)	microQSFP Vendor name (ASCII)
164	Ext. Transceiver (1 Byte)	Extended transceiver codes for InfiniBand
165-167	Vendor OUI (3 Bytes)	microQSFP vendor IEEE vendor company ID
168-183	Vendor PN (16 Bytes)	Part number provided by microQSFP vendor (ASCII)
184-185	Vender Rev. (2 Bytes)	Revision level for part number provided by vendor (ASCII)
186-187	Copper Cable Attenuation	copper cable attenuation in dB at 2.5 GHz (Byte 186) and 5.0 GHz (Byte 187)
188-189	Copper Cable Attenuation	copper cable attenuation in dB at 7.0 GHz (Byte 188) and 12GHz (Byte 189)
190	Max. Case Temp (1 Byte)	Maximum case temperature in degrees C
191	CC_BASE (1 Byte)	Check code for Base ID fields (addresses 12-190)
192-195	Options (4 Bytes)	Rate select, Tx disable, Tx fault, LOS
196-211	Vendor SN (16 Bytes)	Serial number provided by vendor (ASCII)
212-219	Date Code (8 Bytes)	Vendor's manufacturing code
220	Diag Monitor Type (1 Byte)	Indicates which type of diagnostic monitoring is implemented
221	Enhanced Options (1 Byte)	Indicates which optional enhanced features are implemented
222	Reserved (1 Byte)	Reserved
223	CC_EXT (1 Byte)	Check code for the extended ID fields (addresses 192- 222)
224-255	Vendor Specific (32 Bytes)	

microQSFP Pluggable Passive Copper Cable Assemblies

To access select detailed EEPROM memory mapping for these cable assemblies, please click on the following hyperlinks:

- [EEPROM Map microQSFP Straight Assembly \(100G Ethernet\)](#)

SIGNAL INTEGRITY PERFORMANCE

microQSFP to microQSFP DAC Signal Integrity Performance Plots

Insertion Loss (SDD21) of 3m 30AWG microQSFP

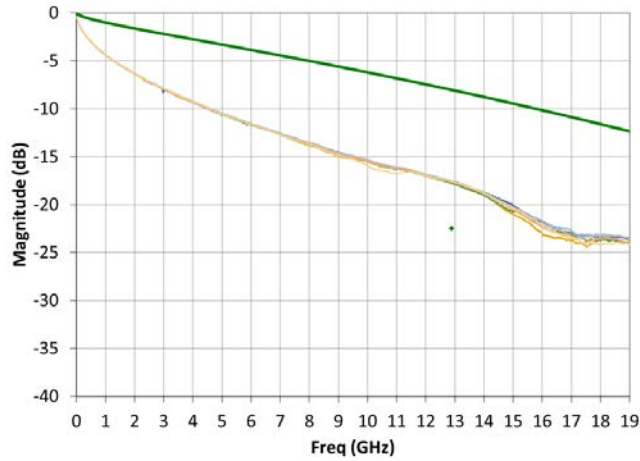

Mode Conversion (SCD21) of 3m 30AWG microQSFP

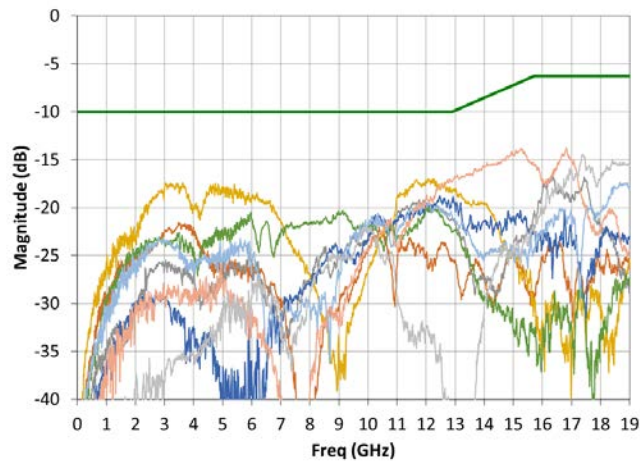

microQSFP Pluggable Passive Copper Cable Assemblies

Return Loss (SDD11) of 3m 30AWG microQSFP

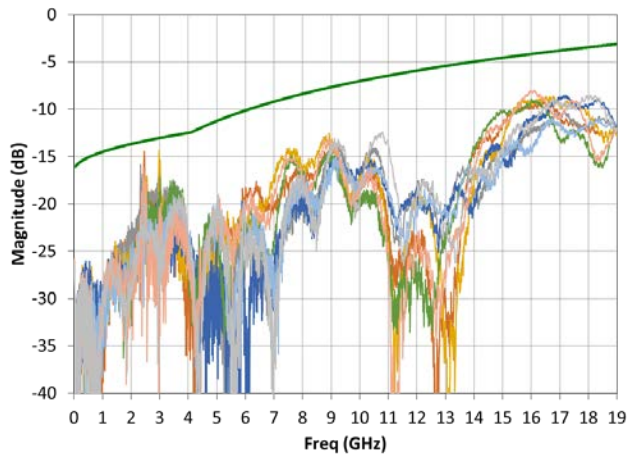

Return Loss (SDD22) of 3m 30AWG microQSFP

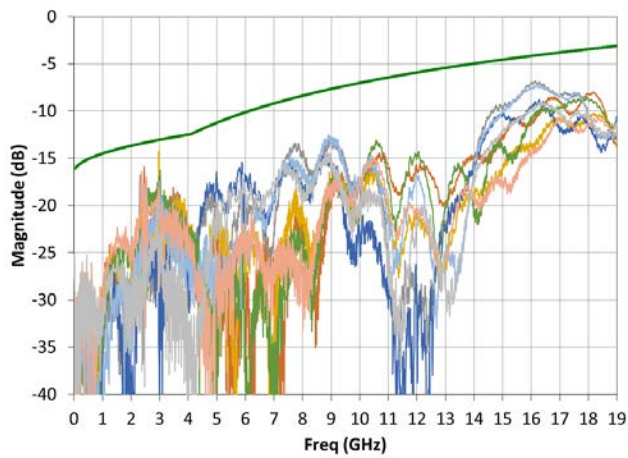

Insertion Loss (SDD21) of 4m 28AWG microQSFP

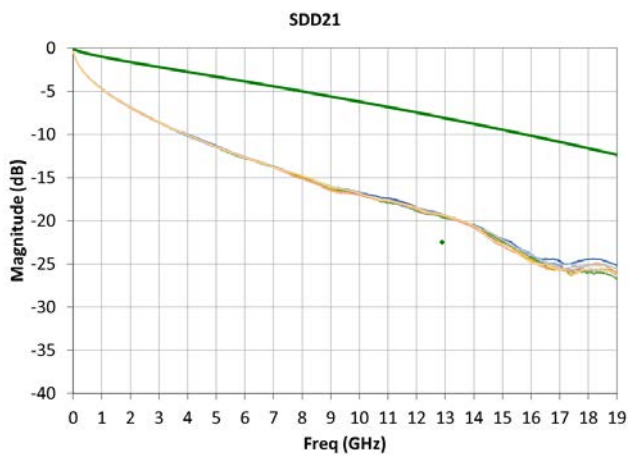

microQSFP Pluggable Passive Copper Cable Assemblies

Conversion Mode (SCD21) of 4m 28AWG microQSFP

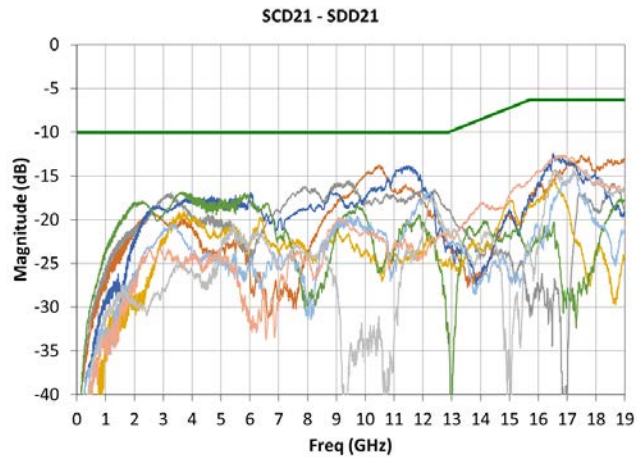

Return Loss (SDD11) of 4m 28AWG microQSFP

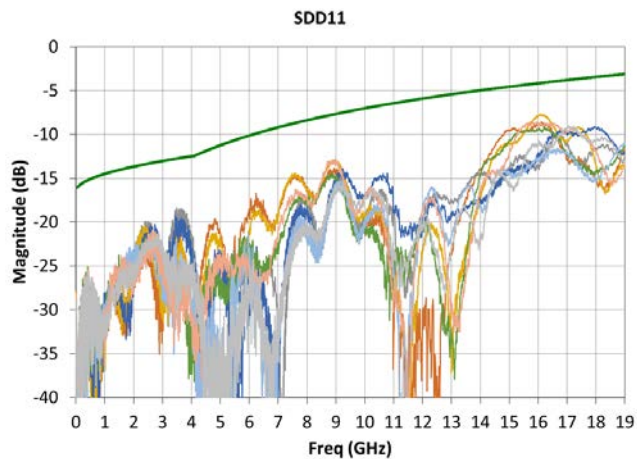

Return Loss (SDD22) of 4m 28AWG microQSFP

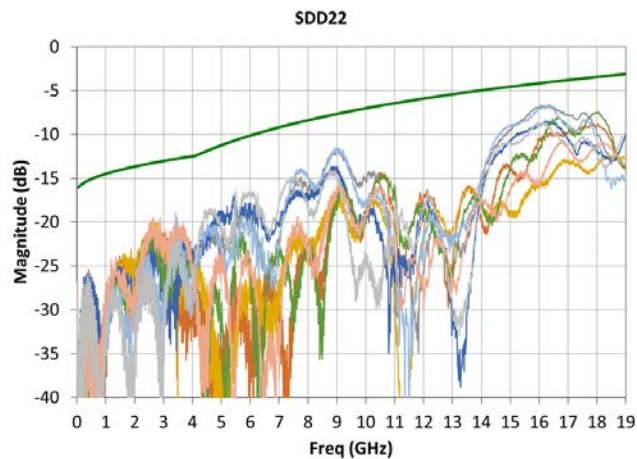

While TE has made every reasonable effort to ensure the accuracy of the information in this document, TE does not guarantee that it is error-free, nor does TE make any other representation, warranty or guarantee that the information is accurate, correct, reliable or current. TE reserves the right to make any adjustments to the information contained herein at any time without notice. TE EXPRESSLY DISCLAIMS ALL IMPLIED WARRANTIES REGARDING THE INFORMATION CONTAINED HEREIN, INCLUDING, BUT NOT LIMITED TO, ANY IMPLIED WARRANTIES OF MERCHANTABILITY OR FITNESS FOR A PARTICULAR PURPOSE. In no event will TE be liable for any direct, indirect, incidental, special or consequential damages arising from or related to recipient's use of the information. It is the sole responsibility of recipient of this information to verify the results of this information using their engineering and product environment. Recipient assumes any and all risks associated with the use of the information.