

Data sheet | Item number: 2042-3819

Relay module; Nominal input voltage: 24 ... 230 V AC/DC; 2 make contact;
Limiting continuous current: 5 A; Green status indicator; Module width: 20 mm

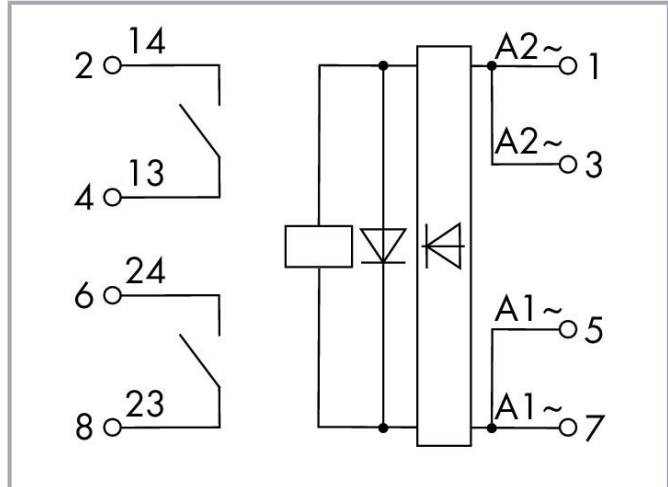

www.wago.com/2042-3819

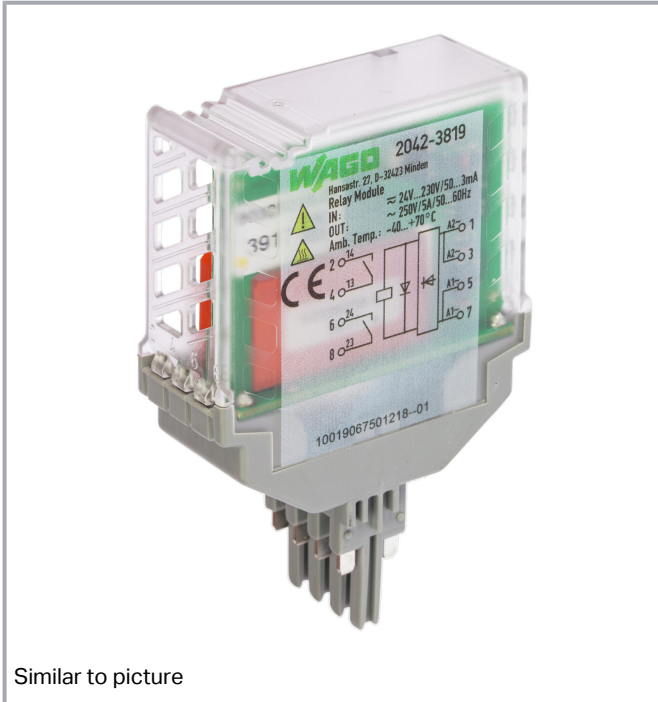

Similar to picture

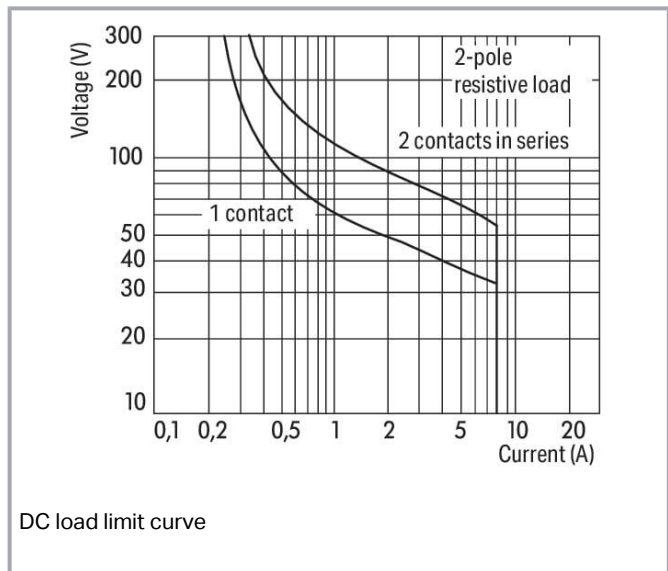
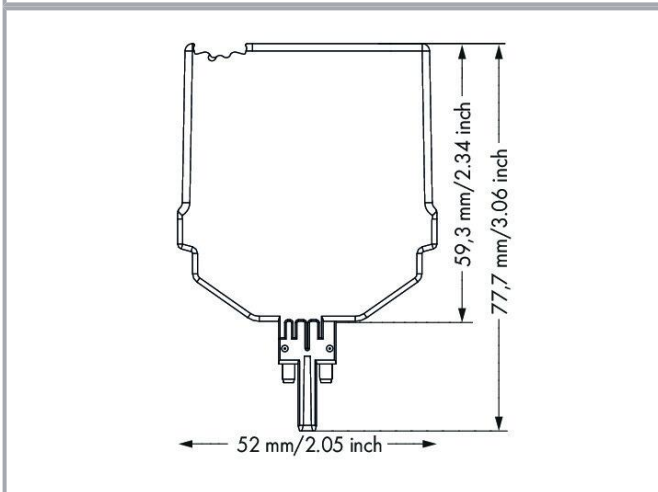

DC load limit curve

Subject to changes. Please also observe the further product documentation!

WAGO GmbH & Co. KG
Hansastr. 27
32423 Minden
Phone: +49571 887-0 | Fax: +49571 887-169
Email: info.de@wago.com | Web: www.wago.com

Do you have any questions about our products?
We are always happy to take your call at +49 (571) 887-44222.



Data

Technical data

Control Circuit

Nominal input voltage U_N	AC/DC 24 ... 230 V
Input voltage range	$\pm 10\%$
Nominal input current at U_N	3 mA (230 V); 49.1 mA (24 V)

Load circuit

Number of make/switch-on contacts	2
Contact material (relay)	AgNi
Limiting continuous current	5 A
Inrush current (resistive) max.	(AC) 15 A / 4 s
Switching voltage (max.)	AC 250 V
Switching power (resistive) max.	AC 1250 VA; DC (see load limit curve)
Recommended minimum load	12 V / 10 mA
Pull-in time (typ.)	8 ms
Drop-out time (typ.)	6 ms
Bounce time (typ.)	4 ms
Electrical life (NO; resistive load; 23 °C)	100 x 10 ³ switching operations
Mechanical life	10 x 10 ⁶ switching operations

Signaling

Status indicator	Green LED
------------------	-----------

Safety and protection

Rated voltage	250 V
Pollution degree	2
Dielectric strength (control/load circuit) (AC, 1 min)	3 kVrms
Dielectric strength (open contact) (AC, 1 min)	1 kVrms
Dielectric strength (channel/channel) (AC, 1 min)	1.5 kVrms
Protection type	IP20

Subject to changes. Please also observe the further product documentation!



Physical data

Width	20.7 mm / 0.815 inches
Height	77.7 mm / 3.059 inches
Height from the surface	59.3 mm / 2.335 inches
Depth	52 mm / 2.047 inches

Mechanical data

Mounting type	Pluggable module for TOPJOB® S carrier terminal block
---------------	---

Material Data

Flammability class per UL94	V0
Fire load	0.894 MJ
Weight	40.1 g

Environmental requirements

Ambient temperature (operation at U_N)	-40 ... +70 °C
Ambient temperature (storage)	-40 ... +85 °C
Processing temperature	-25 ... +50 °C
Operating altitude (max.)	2000 m

Standards and specifications

Standards/specifications	EN 61010-2-201 EN 61373 EN 50121-3-2
--------------------------	--

Commercial data

eCl@ss 10.0	27-14-11-49
eCl@ss 9.0	27-14-11-49
ETIM 8.0	EC002018
ETIM 7.0	EC002018
PU (SPU)	4 pcs
Packaging type	box
Country of origin	DE
GTIN	4055143651752

Subject to changes. Please also observe the further product documentation!

WAGO GmbH & Co. KG
Hansastr. 27
32423 Minden
Phone: +49571 887-0 | Fax: +49571 887-169
Email: info.de@wago.com | Web: www.wago.com

Do you have any questions about our products?
We are always happy to take your call at +49 (571) 887-44222.



Customs tariff number	85364900990
-----------------------	-------------

Environmental Product Compliance

CAS-No.	7439-92-1 79-94-7 80-05-7
REACH Candidate List Substance	2,2',6,6'-tetrabromo-4,4'-isopropylidenediphenol 4,4'-isopropylidenediphenol Lead
RoHS Compliance Status	Compliant,With Exemption
RoHS Exemption	7(a) 7(c)-I 7(c)-II
SCIP notification number (Austria)	f99e1b7d-861d-4229-b914-1a11b2b90025
SCIP notification number (Belgium)	a2718784-121b-4dbf-913d-42fb541c2b3c
SCIP notification number (Bulgaria)	bafd7541-92b5-4d25-badc-78ff2c4294c4
SCIP notification number (Czech Republic)	579a6184-8fbe-47c7-8ed4-604b6683f080
SCIP notification number (Denmark)	bbf658d6-634d-49c9-a1b2-dd7579e41577
SCIP notification number (Finland)	9b9b7405-55e1-4ca8-ba61-9234984ec772
SCIP notification number (France)	7e3bb507-a99f-45e7-8c92-eb994bd20b25
SCIP notification number (Germany)	c5aff5f6-173d-442d-bc38-07d9cb3f8fa6
SCIP notification number (Hungary)	0efbf69b-4b16-46e9-ae00-806b8d33562d
SCIP notification number (Italy)	16d38669-02ff-4b35-bbdf-f1a27104887b
SCIP notification number (Netherlands)	e6216ab1-f06a-4b05-969c-a3d5ec22d5ce
SCIP notification number (Poland)	249bb583-5fc2-421c-b0bd-0ae8313272c7
SCIP notification number (Romania)	9c8105d8-6978-4efe-a3f6-f1612c2a70d0
SCIP notification number (Sweden)	91793361-d3c3-4fcd-bb53-d4a8c7cf320f

Approvals / Certificates

General approvals

Logo	Approval	Additional Approval Text	Certificate name
	EAC Brjansker Zertifizierungsstelle	TP TC 020/2011	EAC_Certificate_RU_C-DE.AM02.B.00115_19
	EAC Brjansker Zertifizierungsstelle	TP TC 004/2011	EAC RU C-DE.AM02.B.00122/19
UL		UL 61010-1	E175199

Subject to changes. Please also observe the further product documentation!











Underwriters Laboratories Inc. (ORDINARY LOCATIONS)

Declarations of conformity and manufacturer's declarations

Logo	Approval	Additional Approval Text	Certificate name
	EU-Declaration of Conformity WAGO GmbH & Co. KG	-	-

Optional accessories

End plate

End plate		
	Item no.: 2002-1892 End and intermediate plate; 1 mm thick; orange	www.wago.com/2002-1892
	Item no.: 2002-1891 End and intermediate plate; 1 mm thick; gray	www.wago.com/2002-1891
	Item no.: 2002-1991 End and intermediate plate; 1 mm thick; gray	www.wago.com/2002-1991
	Item no.: 2002-1992 End and intermediate plate; 1 mm thick; orange	www.wago.com/2002-1992
	Item no.: 2002-1691 End and intermediate plate; 1 mm thick; gray	www.wago.com/2002-1691
	Item no.: 2002-1692 End and intermediate plate; 1 mm thick; orange	www.wago.com/2002-1692
	Item no.: 2002-1791 End and intermediate plate; 1 mm thick; gray	www.wago.com/2002-1791
	Item no.: 2002-1792 End and intermediate plate; 1 mm thick; orange	www.wago.com/2002-1792

Marking accessories

Marking strip		
	Item no.: 2009-110 Marking strips; for Smart Printer; on reel; not stretchable; plain; snap-on type; white	www.wago.com/2009-110
Marker		

Subject to changes. Please also observe the further product documentation!



Item no.: 2009-115

WMB-Inline; for Smart Printer; 1500 pieces on roll; stretchable 5 - 5.2 mm; plain; snap-on type; white

www.wago.com/2009-115



Item no.: 793-501

WMB marking card; as card; not stretchable; plain; snap-on type; white

www.wago.com/793-501



Item no.: 793-5501

WMB marking card; as card; for terminal block width 5 - 17.5 mm; stretchable 5 - 5.2 mm; plain; snap-on type; white

www.wago.com/793-5501

Terminal blocks

Carrier terminal block for modules and plugs



Item no.: 2002-1961

2-conductor carrier terminal block; with additional jumper position; for DIN-rail 35 x 15 and 35 x 7.5; 2.5 mm²; Push-in CAGE CLAMP®; 2,50 mm²; gray

www.wago.com/2002-1961



Item no.: 2002-1761

3-conductor carrier terminal block; for DIN-rail 35 x 15 and 35 x 7.5; 2.5 mm²; Push-in CAGE CLAMP®; 2,50 mm²; gray

www.wago.com/2002-1761



Item no.: 2002-1861

4-conductor carrier terminal block; for DIN-rail 35 x 15 and 35 x 7.5; 2.5 mm²; Push-in CAGE CLAMP®; 2,50 mm²; gray

www.wago.com/2002-1861

Downloads

Documentation

Bid Text

2042-3819 docx - Datei	2019 Feb 20	docx 17.3 kB	Download
---------------------------	-------------	-----------------	----------

2042-3819 X81 - Datei	2019 Feb 19	xml 4.0 kB	Download
--------------------------	-------------	---------------	----------

Instruction Leaflet

Pluggable Relay Module / Pluggable Solid-State Relay Module	V 1.1.0	pdf 2.0 MB	Download
---	---------	---------------	----------

Additional Information

Disposal and Recycling Electrical and electronic equipment, Batteries, Packaging	V 1.1.0 2022 Aug 18	pdf 2.2 MB	Download
---	------------------------	---------------	----------

Subject to changes. Please also observe the further product documentation!

WAGO GmbH & Co. KG
Hansastr. 27
32423 Minden
Phone: +49571 887-0 | Fax: +49571 887-169
Email: info.de@wago.com | Web: www.wago.com

Do you have any questions about our products?
We are always happy to take your call at +49 (571) 887-44222.



CAD/CAE-Data

CAE data

ZUKEN Portal 2042-3819	URL	Download
------------------------	---------------------	--------------------------

CAD data

2D/3D Models 2042-3819	URL	Download
------------------------	---------------------	--------------------------

Environmental Product Compliance

Compliance Search

Environmental Product Compliance 2042-3819	URL	Download
--	---------------------	--------------------------

Relay module; Nominal input voltage: 24 ... 230 V AC/DC; 2 make contact; Limiting continuous current: 5 A; Green status indicator; Module width: 20 mm

Installation Notes

Subject to changes. Please also observe the further product documentation!