

Data sheet | Item number: 285-1164

2-conductor through terminal block; 185 mm²; lateral marker slots; with fixing flanges; POWER CAGE CLAMP; 185,00 mm²; blue



www.wago.com/285-1164



Color: ■

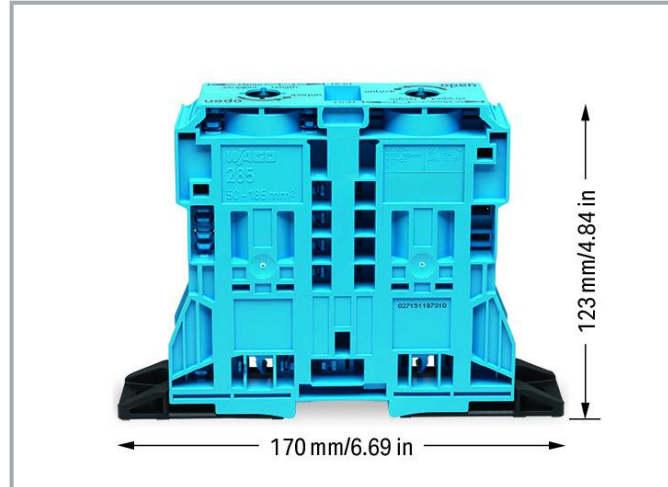

Data

Electrical data

Ratings per IEC/EN

Ratings per	IEC/EN 60947-7-1
Nominal voltage (III/3)	1000 V
Rated impulse voltage (III/3)	12 kV
Rated current	353 A
Legend (ratings)	(III / 3) ≙ Overvoltage category III / Pollution degree 3

Ratings per IEC/EN 2

Rated voltage (III/3) 2	1500 V
Rated surge voltage (III/3) 2	12 kV

Ratings per UL 1059

Approvals per	UL 1059
---------------	---------

Subject to changes. Please also observe the further product documentation!

WAGO GmbH & Co. KG
Hansastr. 27
32423 Minden
Phone: +49571 887-0 | Fax: +49571 887-169
Email: info.de@wago.com | Web: www.wago.com

Do you have any questions about our products?
We are always happy to take your call at +49 (571) 887-44222.



Rated voltage UL (Use Group B)	600 V
Rated current UL (Use Group B)	310 A
Rated voltage UL (Use Group C)	600 V
Rated current UL (Use Group C)	310 A

Ratings per CSA

Approvals per	CSA 22.2 No 158
Rated voltage CSA (Use Group B)	1000 V
Rated current CSA (Use Group B)	310 A
Rated voltage CSA (Use Group C)	1000 V
Rated current CSA (Use Group D)	310 A

Power loss

Power loss, per pole (potential)	11.215 W
Rated current I_N for specified power loss	353 A
Resistance value for specified, current-dependent power loss	9 Ω

General

Voltage type 1	AC/DC
Voltage type 2	DC

Connection data

Connection points	2
Total number of potentials	1
Number of levels	1
Number of jumper slots	2

Connection 1

Connection technology	POWER CAGE CLAMP
Actuation type	T-wrench; 8 mm
Connectable conductor materials	Copper
Nominal cross-section	185 mm ² / 350 kcmil
Solid conductor	50 ... 185 mm ² / 1/0 AWG ... 350 kcmil
Stranded conductor	50 ... 185 mm ² / 1/0 AWG ... 350 kcmil
Fine-stranded conductor	50 ... 185 mm ² / 1/0 AWG ... 350 kcmil
Fine-stranded conductor; with insulated ferrule	50 ... 150 mm ² / 1/0 AWG ... 300 kcmil

Subject to changes. Please also observe the further product documentation!



Fine-stranded conductor; with uninsulated ferrule	50 ... 185 mm ² / 1/0 AWG ... 350 kcmil
Strip length	45 ... 47 mm / 1.77 ... 1.85 inches
Wiring direction	Side-entry wiring

Physical data

Width	32 mm / 1.26 inches
Height from the surface	123 mm / 4.843 inches
Depth	170 mm / 6.693 inches

Mechanical Data

Mounting type	Mounting flange
Marking level	Side marking

Material Data

Note (material data)	Information on material specifications can be found here
Color	blue
Material group	I
Insulation material	Polyamide (PA66)
Flammability class per UL94	V0
Fire load	5.446 MJ
Weight	547.2 g

Environmental requirements

Processing temperature	-35 ... +85 °C
Continuous operating temperature	-60 ... +105 °C

Commercial data

eCl@ss 10.0	27-14-11-20
eCl@ss 9.0	27-14-11-20
ETIM 8.0	EC000897
ETIM 7.0	EC000897
PU (SPU)	4 pcs
Packaging type	box
Country of origin	DE

Subject to changes. Please also observe the further product documentation!

WAGO GmbH & Co. KG
 Hansastr. 27
 32423 Minden
 Phone: +49571 887-0 | Fax: +49571 887-169
 Email: info.de@wago.com | Web: www.wago.com

Do you have any questions about our products?
 We are always happy to take your call at +49 (571) 887-44222.





GTIN	4055143424158
Customs tariff number	85369010000

Environmental Product Compliance



RoHS Compliance Status	Compliant, No Exemption
------------------------	-------------------------

Approvals / Certificates

General approvals

Logo	Approval	Additional Approval Text	Certificate name
	CCA DEKRA Certification B.V.	EN 60947	NTR NL 7965
	CSA DEKRA Certification B.V.	C22.2	154112
	KEMA/KEUR DEKRA Certification B.V.	EN 60947	71- 126013
	UL Underwriters Laboratories Inc.	UL 1059	E45172

Declarations of conformity and manufacturer's declarations

Logo	Approval	Additional Approval Text	Certificate name
	EU-Declaration of Conformity WAGO GmbH & Co. KG	-	-
	UK-Declaration of Conformity WAGO GmbH & Co. KG	-	-

Approvals for marine applications

Logo	Approval	Additional Approval Text	Certificate name
------	----------	--------------------------	------------------

Subject to changes. Please also observe the further product documentation!

WAGO GmbH & Co. KG
Hansastr. 27
32423 Minden
Phone: +49571 887-0 | Fax: +49571 887-169
Email: info.de@wago.com | Web: www.wago.com

Do you have any questions about our products?
We are always happy to take your call at +49 (571) 887-44222.



ABS
American Bureau of Shipping

EN 60947

20-
HG1941090-
PDA

Optional accessories

Mounting

Mounting accessories



Item no.: 285-1179

Fixing element; for 185 mm² high-current terminal blocks; orange

www.wago.com/285-1179

Protective warning marker

Cover



Item no.: 285-1177

Protective warning marker; with high-voltage symbol, black; yellow

www.wago.com/285-1177



Item no.: 285-1176

Protective warning marker; yellow

www.wago.com/285-1176

Marking accessories

Marking strip



Item no.: 2009-110

Marking strips; for Smart Printer; on reel; not stretchable; plain; snap-on type; white

www.wago.com/2009-110

Marker



Item no.: 2009-115/000-002

WMB-Inline; for Smart Printer; 1500 pieces on roll; stretchable 5 - 5.2 mm; plain; snap-on type; yellow

www.wago.com/2009-115/000-002



Item no.: 2009-115/000-007

WMB-Inline; for Smart Printer; 1500 pieces on roll; stretchable 5 - 5.2 mm; plain; snap-on type; gray

www.wago.com/2009-115/000-007



Item no.: 2009-115/000-017

WMB-Inline; for Smart Printer; 1500 pieces on roll; stretchable 5 - 5.2 mm; plain; snap-on type; light green

www.wago.com/2009-115/000-017



Item no.: 2009-115/000-023

WMB-Inline; for Smart Printer; 1500 pieces on roll; stretchable 5 - 5.2 mm; plain; snap-on type; green

www.wago.com/2009-115/000-023



Item no.: 2009-115/000-024

WMB-Inline; for Smart Printer; 1500 pieces on roll; stretchable 5 - 5.2 mm; plain; snap-on type; violet

www.wago.com/2009-115/000-024

Subject to changes. Please also observe the further product documentation!

WAGO GmbH & Co. KG

Hansastr. 27

32423 Minden

Phone: +49571 887-0 | Fax: +49571 887-169

Email: info.de@wago.com | Web: www.wago.com

Do you have any questions about our products?

We are always happy to take your call at +49 (571) 887-44222.



Item no.: 2009-115

WMB-Inline; for Smart Printer; 1500 pieces on roll; stretchable 5 - 5.2 mm; plain; snap-on type; white

www.wago.com/2009-115



Item no.: 793-5501/000-007

WMB marking card; as card; for terminal block width 5 - 17.5 mm; stretchable 5 - 5.2 mm; plain; snap-on type; gray

www.wago.com/793-5501/000-007



Item no.: 793-5501/000-012

WMB marking card; as card; for terminal block width 5 - 17.5 mm; stretchable 5 - 5.2 mm; plain; snap-on type; orange

www.wago.com/793-5501/000-012



Item no.: 793-5501/000-014

WMB marking card; as card; for terminal block width 5 - 17.5 mm; stretchable 5 - 5.2 mm; plain; snap-on type; brown

www.wago.com/793-5501/000-014



Item no.: 793-5501/000-017

WMB marking card; as card; for terminal block width 5 - 17.5 mm; stretchable 5 - 5.2 mm; plain; snap-on type; light green

www.wago.com/793-5501/000-017



Item no.: 793-5501/000-023

WMB marking card; as card; for terminal block width 5 - 17.5 mm; stretchable 5 - 5.2 mm; plain; snap-on type; green

www.wago.com/793-5501/000-023



Item no.: 793-5501/000-024

WMB marking card; as card; for terminal block width 5 - 17.5 mm; stretchable 5 - 5.2 mm; plain; snap-on type; violet

www.wago.com/793-5501/000-024



Item no.: 793-501/000-002

WMB marking card; as card; not stretchable; plain; snap-on type; yellow

www.wago.com/793-501/000-002



Item no.: 793-501/000-007

WMB marking card; as card; not stretchable; plain; snap-on type; gray

www.wago.com/793-501/000-007



Item no.: 793-501/000-017

WMB marking card; as card; not stretchable; plain; snap-on type; light green

www.wago.com/793-501/000-017



Item no.: 793-501/000-012

WMB marking card; as card; not stretchable; plain; snap-on type; orange

www.wago.com/793-501/000-012

Subject to changes. Please also observe the further product documentation!

WAGO GmbH & Co. KG

Hansastr. 27

32423 Minden

Phone: +49571 887-0 | Fax: +49571 887-169

Email: info.de@wago.com | Web: www.wago.com

Do you have any questions about our products?

We are always happy to take your call at +49 (571) 887-44222.



Item no.: 793-501/000-023
WMB marking card; as card; not stretchable; plain; snap-on type; green

www.wago.com/793-501/000-023



Item no.: 793-501/000-006
WMB marking card; as card; not stretchable; plain; snap-on type; blue

www.wago.com/793-501/000-006



Item no.: 793-501/000-005
WMB marking card; as card; not stretchable; plain; snap-on type; red

www.wago.com/793-501/000-005



Item no.: 793-501
WMB marking card; as card; not stretchable; plain; snap-on type; white

www.wago.com/793-501



Item no.: 793-501/000-024
WMB marking card; as card; not stretchable; plain; snap-on type; violet

www.wago.com/793-501/000-024



Item no.: 793-5501/000-005
WMB marking card; as card; for terminal block width 5 - 17.5 mm; stretchable 5 - 5.2 mm; plain; snap-on type; red

www.wago.com/793-5501/000-005



Item no.: 793-5501/000-002
WMB marking card; as card; for terminal block width 5 - 17.5 mm; stretchable 5 - 5.2 mm; plain; snap-on type; yellow

www.wago.com/793-5501/000-002



Item no.: 793-5501/000-006
WMB marking card; as card; for terminal block width 5 - 17.5 mm; stretchable 5 - 5.2 mm; plain; snap-on type; blue

www.wago.com/793-5501/000-006



Item no.: 793-5501
WMB marking card; as card; for terminal block width 5 - 17.5 mm; stretchable 5 - 5.2 mm; plain; snap-on type; white

www.wago.com/793-5501



Item no.: 2009-115/000-012
WMB-Inline; for Smart Printer; 1500 pieces on roll; stretchable 5 - 5.2 mm; plain; snap-on type; orange

www.wago.com/2009-115/000-012



Item no.: 2009-115/000-006
WMB-Inline; for Smart Printer; 1500 pieces on roll; stretchable 5 - 5.2 mm; plain; snap-on type; blue

www.wago.com/2009-115/000-006



Item no.: 2009-115/000-005
WMB-Inline; for Smart Printer; 1500 pieces on roll; stretchable 5 - 5.2 mm; plain; snap-on type; red

www.wago.com/2009-115/000-005

Subject to changes. Please also observe the further product documentation!

Tool

Operating tool

**Item no.: 285-172**

Allen wrench; with a partially insulated shaft; green

www.wago.com/285-172**Item no.: 285-173**

Allen wrench; with a partially insulated shaft; with anti-rotation protection; green

www.wago.com/285-173

Cover

Cover

**Item no.: 285-1178**Finger guard; touchproof cover protects unused conductor entries and jumper slots; for 185 mm² high-current terminal blocks; yellowwww.wago.com/285-1178

Ferrule

Ferrule

**Item no.: 216-413**Ferrule; Sleeve for 25 mm² / AWG 4; uninsulated; electro-tin plated; electrolytic copper; gastight crimped; acc. to DIN 46228, Part 1/08.92; silver-coloredwww.wago.com/216-413**Item no.: 216-414**Ferrule; Sleeve for 35 mm² / AWG 2; uninsulated; electro-tin plated; electrolytic copper; gastight crimped; acc. to DIN 46228, Part 1/08.92; silver-coloredwww.wago.com/216-414**Item no.: 216-425**Ferrule; Sleeve for 50 mm² / AWG 1; uninsulated; electro-tin plated; electrolytic copper; gastight crimped; acc. to DIN 46228, Part 1/08.92www.wago.com/216-425**Item no.: 216-424**Ferrule; Sleeve for 35 mm² / AWG 2; uninsulated; electro-tin plated; electrolytic copper; gastight crimped; acc. to DIN 46228, Part 1/08.92; silver-coloredwww.wago.com/216-424**Item no.: 216-435**Ferrule; Sleeve for 50 mm² / AWG 1; uninsulated; electro-tin plated; electrolytic copper; gastight crimped; acc. to DIN 46228, Part 1/08.92www.wago.com/216-435

Voltage tap

Power tap

**Item no.: 285-1175**Power tap; for 185 mm² high-current terminal blocks; 10,00 mm²; graywww.wago.com/285-1175

Current and Voltage Taps

Current and voltage tap

**Item no.: 855-1851/350-000**Current and voltage tap up to 185 mm²; Primary rated current: 350 A; Secondary rated current: 1 A; Rated power: 0.2 VA; Accuracy class: 0.5; fusedwww.wago.com/855-1851/350-000

Jumpers

Jumper

Subject to changes. Please also observe the further product documentation!

WAGO GmbH & Co. KG

Hansastr. 27

32423 Minden

Phone: +49571 887-0 | Fax: +49571 887-169

Email: info.de@wago.com | Web: www.wago.com

Do you have any questions about our products?

We are always happy to take your call at +49 (571) 887-44222.



Item no.: 285-1171
Jumper; insulated; gray

www.wago.com/285-1171

Downloads

Documentation

Bid Text

285-1164 X81 - Datei	2019 Feb 19	xml 4.0 kB	Download
-------------------------	-------------	---------------	----------

285-1164 doc - Datei	2018 Jan 4	doc 26.1 kB	Download
-------------------------	------------	----------------	----------

Additional Information

Technical Section Technical explanations		pdf 2.2 MB	Download
---	--	---------------	----------

CAD/CAE-Data

CAE data

EPLAN Data Portal 285-1164		URL	Download
----------------------------	--	-----	----------

ZUKEN Portal 285-1164		URL	Download
-----------------------	--	-----	----------

CAD data

2D/3D Models 285-1164		URL	Download
-----------------------	--	-----	----------

Environmental Product Compliance

Compliance Search

Environmental Product Compliance 285-1164 2-conductor through terminal block; 185 mm ² ; lateral marker slots; with fixing flanges; POWER CAGE CLAMP; 185,00 mm ² ; blue		URL	Download
---	--	-----	----------

Installation Notes

Subject to changes. Please also observe the further product documentation!

WAGO GmbH & Co. KG
Hansastr. 27
32423 Minden
Phone: +49571 887-0 | Fax: +49571 887-169
Email: info.de@wago.com | Web: www.wago.com

Do you have any questions about our products?
We are always happy to take your call at +49 (571) 887-44222.

Installation

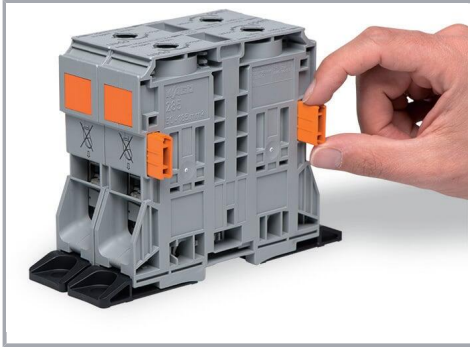

Optionally, insert block-to-block connector (285-1179) into housing slot.

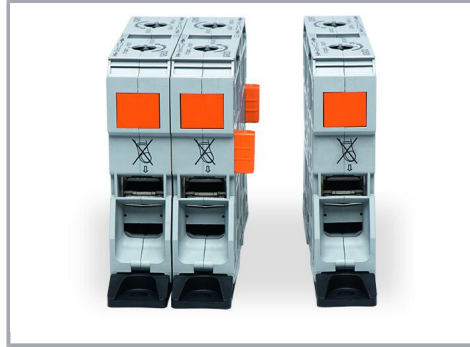

Align and snap high-current, through terminal blocks together.

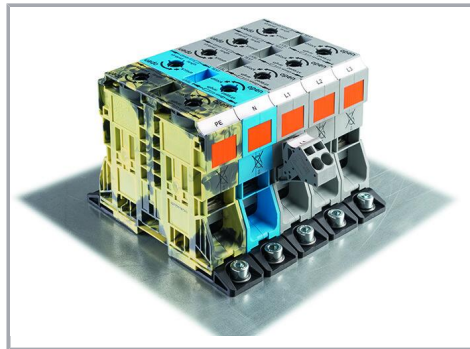
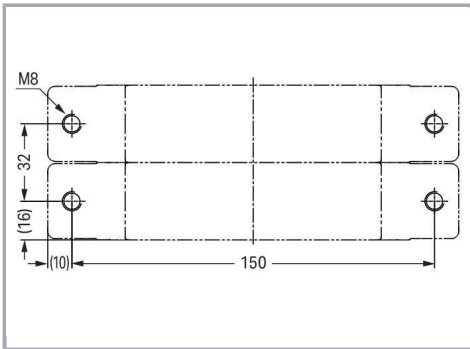

Secure the terminal block to a mounting plate using two M8 cylinder-head screws and appropriate washers.

Subject to changes. Please also observe the further product documentation!