

Part No. 1002436

Vertical Wideband FR4 Embedded LTE / LPWA Antenna

700 / 750 / 850 / 900 / 1800 / 1900 / 2100 MHz

Supports: Broadband LTE (OCTA-BAND), LTE CAT-M, NB-IoT, SigFox, LoRa, Cellular LPWA, RPMA, Firstnet



KYOCERA AVX Vertical Wideband Embedded LTE/LPWA antenna utilizes Isolated Magnetic Dipole™ (IMD) technology which address the challenges facing today’s product designers. IMD’s high performance and isolation characteristics offer better connectivity and minimal interference. A versatile solution such as the 1002436 FR4 antenna offers support for Broadband LTE, LTE CAT-M, NB-IoT, SigFox, Lora, Cellular LPWA, RPMA applications.

Stays in Tune

IMD antenna technology provides superior RF field containment, resulting in less interaction with surrounding components. KYOCERA AVX IMD antennas resist detuning; providing a robust radio link regardless of the usage position

Vertical Wideband FR4 Embedded LTE / LPWA

Low Band 700 - 960 MHz
High Band 1700 - 2700 MHz

KYOCERA AVX antennas use patented IMD technology in many antenna configurations to provide high performance. IMD antennas requires a smaller design keep-out area, carry lower program development risk which yields a quicker time-to-market, without sacrificing RF performance.

KEY BENEFITS

Reduced Costs and Time-to-Market

Standard antenna eliminates design fees and cycle time associated with a custom solution; getting products to market faster.

Greater Flexibility with Unique Form Factors

KYOCERA AVX technology helps you deliver more advanced ergonomic designs without adverse impact on product performance.

Environmental Compliance

Comply with latest RoHS requirements

APPLICATIONS

- Medical applications
- Home automation
- Smart metering
- M2M, Industrial devices
- Automotive
- Healthcare
- Point of Sale
- Tracking
- Cellular
- 3G Systems
- IoT
- Firstnet

Electrical Specifications

Typical Characteristics on 50 x 120 mm ground plane

Frequency	698 - 960 MHz	1710 - 2200 MHz	2500 – 2700 MHz
Efficiency	69%	63%	53%
VSWR	< 3.5:1	< 2.5:1	< 2.5:1
Peak Gain	2.3 dBi	3.2 dBi	3.0 dBi
Polarization	Linear		
Power Handling	2 Watts CW		
Radiation Pattern	Omni-directional		
Feed Point Impedance	50 ohms unbalanced		

Mechanical Specifications & Ordering Part Number

Ordering Part #	1002436
Dimensions (mm)	50.6 x 19.6 x 1.6
Weight (grams)	3.05
Mounting	Vertical FR4 antenna with through-hole solder pads
Packaging	5,000 pcs/box
Demo Board	1002436-01

Broadband LTE Embedded KYOCERA AVX FR4 Antenna.
 KYOCERA AVX produces a wide variety of standard and custom antennas to meet user needs.

Antenna Dimensions

Typical antenna dimensions (mm)

Part Number	A	B	C
1002436	50.6 ± 0.3	19.6 ± 0.3	1.6 ± 0.2

Pin Descriptions

Pin#	Description
1	Feed
2	Ground
6	Low Band Tuning

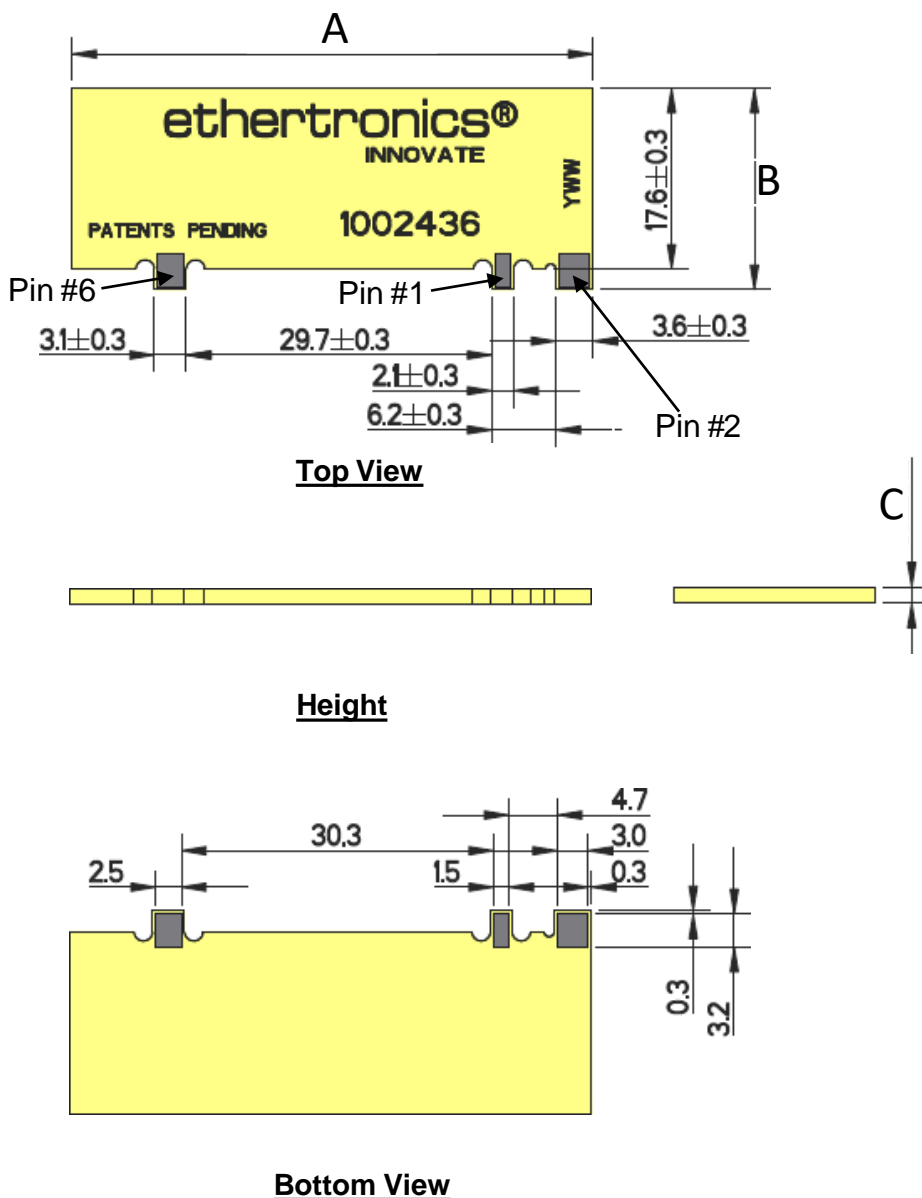

Broadband LTE Embedded KYOCERA AVX FR4 Antenna.
 KYOCERA AVX produces a wide variety of standard and custom antennas to meet user needs.

VSWR and Efficiency Plots

Typical performance on 120 x 50 mm PCB

Low Band VSWR

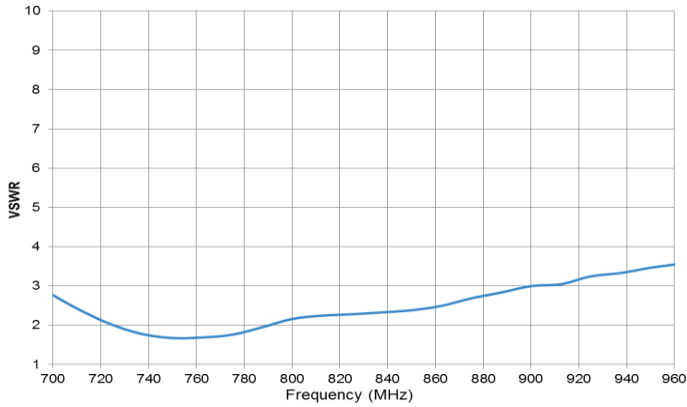

Low Band Efficiency

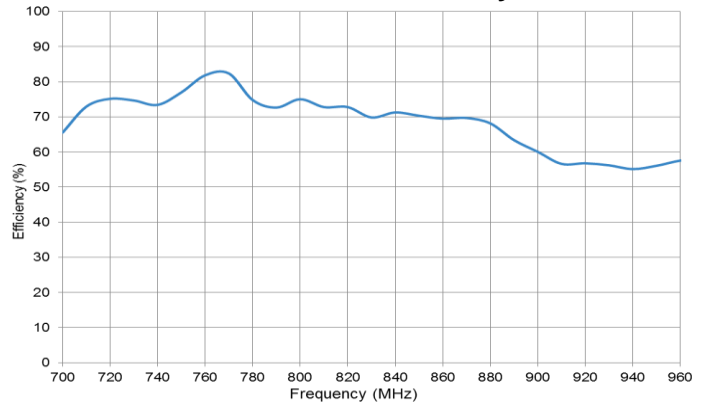

High Band VSWR

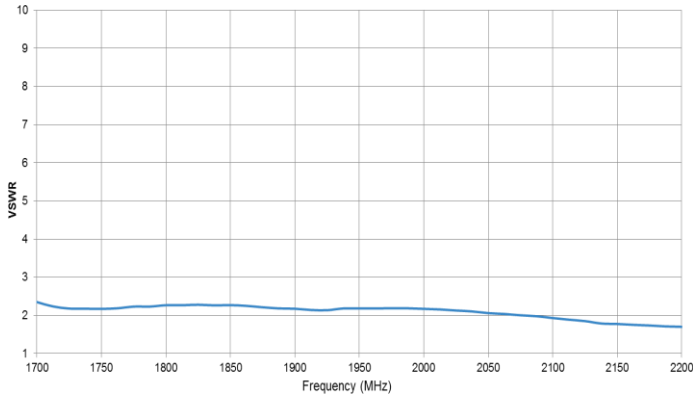

High Band Efficiency

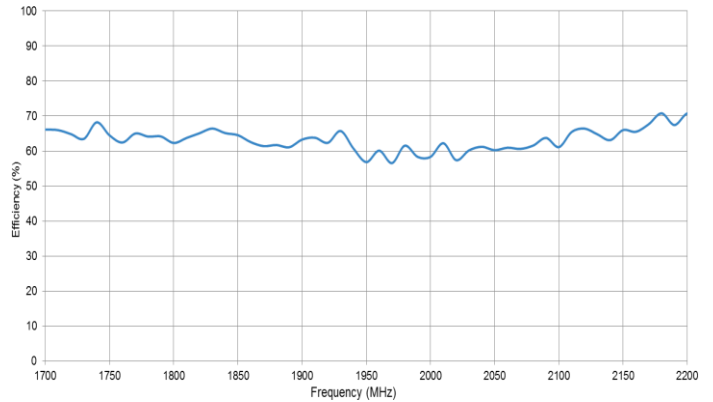

High High Band VSWR

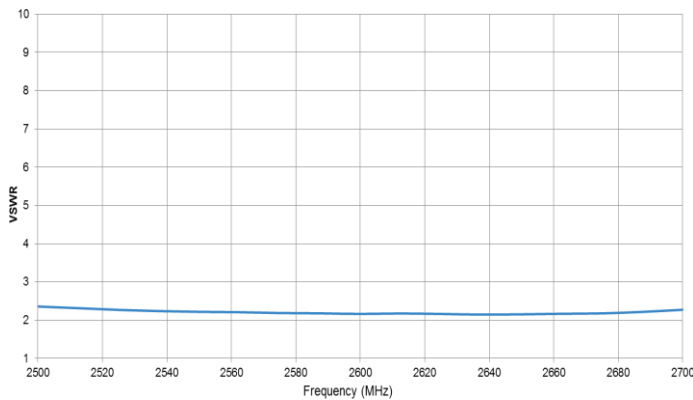

High High Band Efficiency

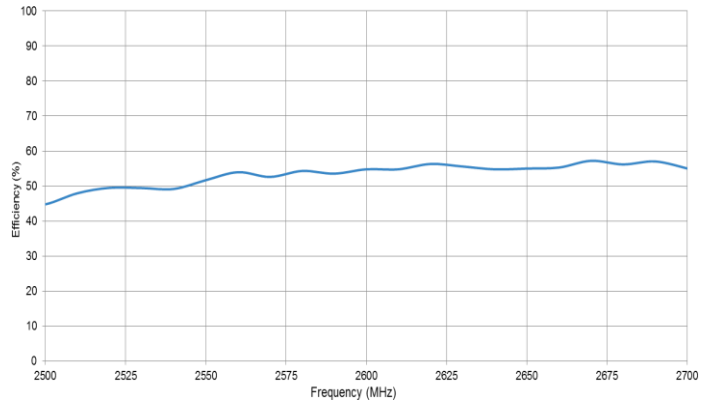

Broadband LTE Embedded KYOCERA AVX FR4 Antenna.
 KYOCERA AVX produces a wide variety of standard and custom antennas to meet user needs.

Antenna Radiation Patterns

Typical performance on 120 x 50 mm PCB
 Measured @ 700, 750, 850, 900, 1710, 1800, 1900, 2150 MHz

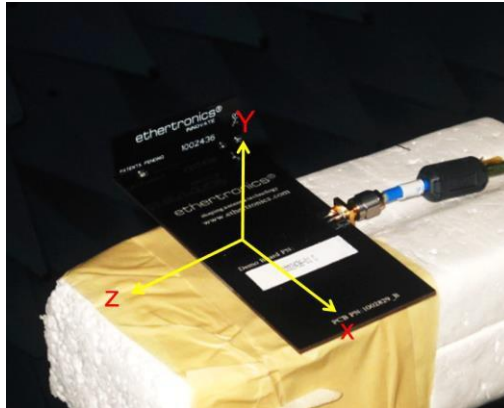

Low Band Measured at 700, 750, 850, 900 MHz

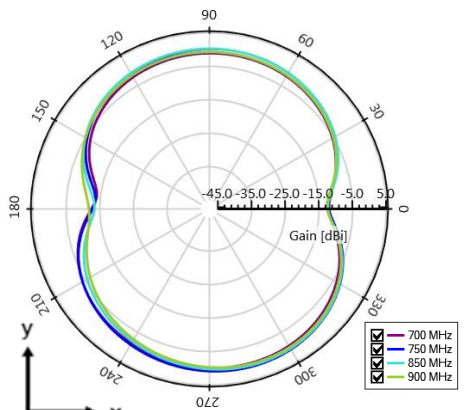
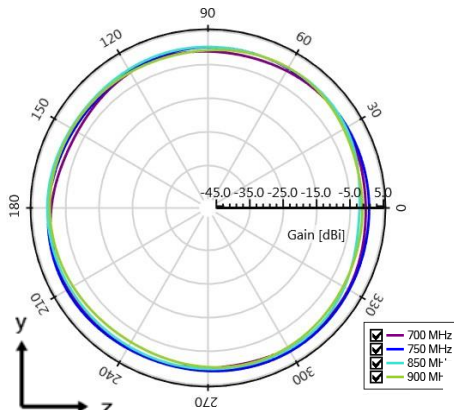
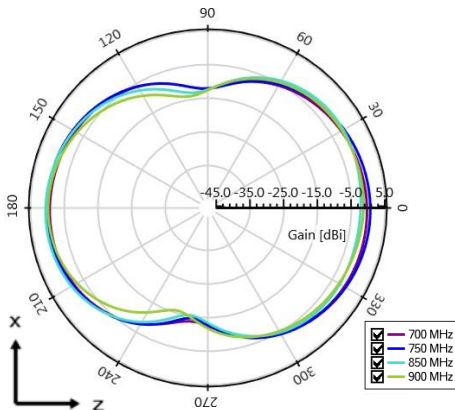

High Band Measured at 1710, 1800, 1900, 2150 MHz

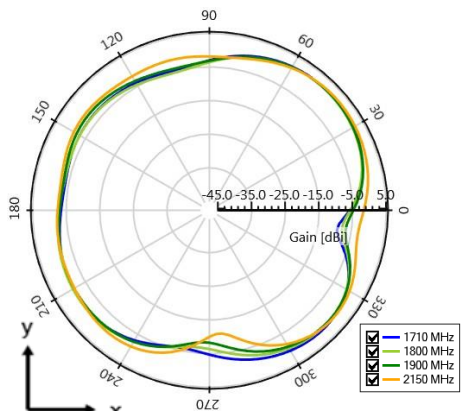
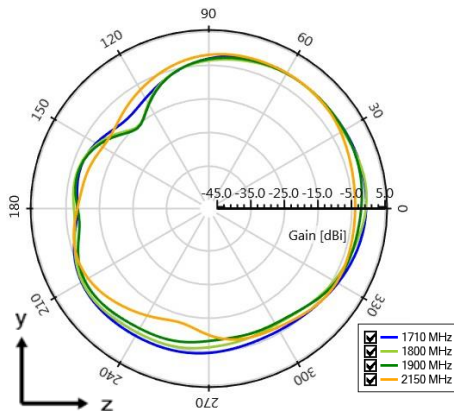
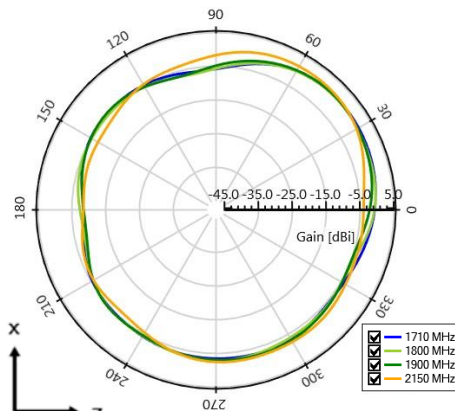

Broadband LTE Embedded KYOCERA AVX FR4 Antenna.
 KYOCERA AVX produces a wide variety of standard and custom antennas to meet user needs.

Antenna Radiation Patterns

Typical performance on 120 x 50 mm PCB
 Measured @ 2500, 2600, 2690 MHz

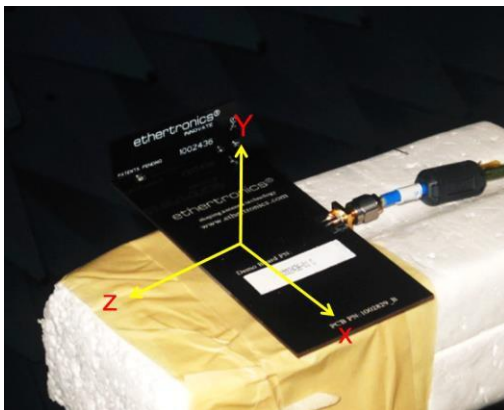

High High Band Measured at 2500, 2600, 2690 MHz

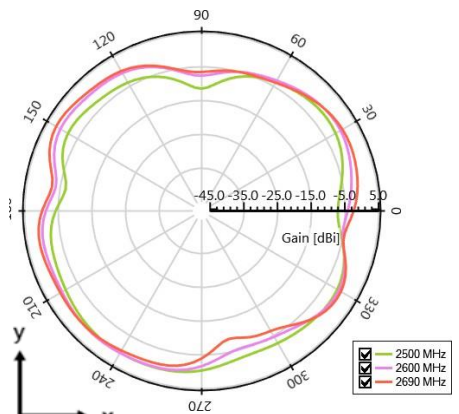
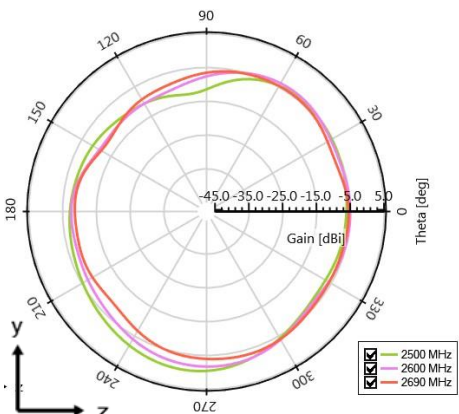
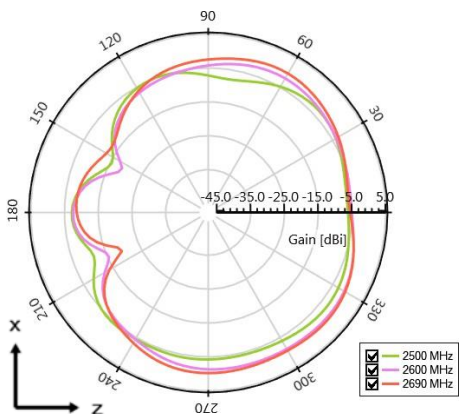

Broadband LTE Embedded KYOCERA AVX FR4 Antenna.
 KYOCERA AVX produces a wide variety of standard and custom antennas to meet user needs.

Antenna Layout (On-Ground)

Typical layout dimensions (mm)

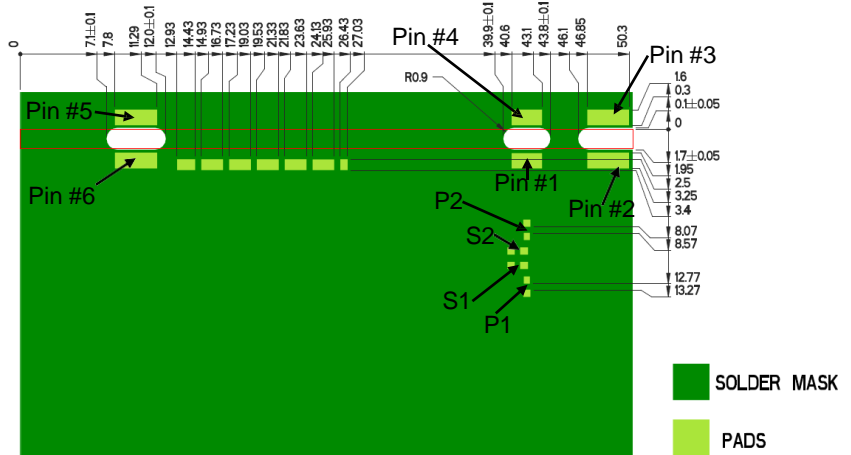
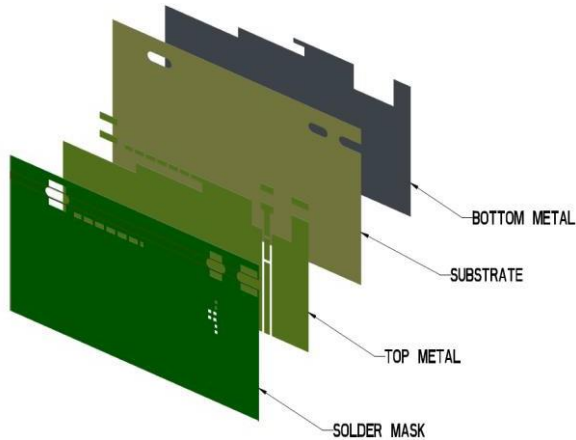

Pin Descriptions

Pin#	Description
1	Feed
2	Ground
3	Dummy Pad
4	Dummy Pad
5	Dummy Pad
6	Low Band Tuning

Matching Pi Network + Tuning values

Component	Value	Tolerance
P1	6.8pF	±0.1pF
S1	22nH	±5%
S2	DNI	N/A
P2	0Ω	N/A
R1 – R6	DNI	N/A

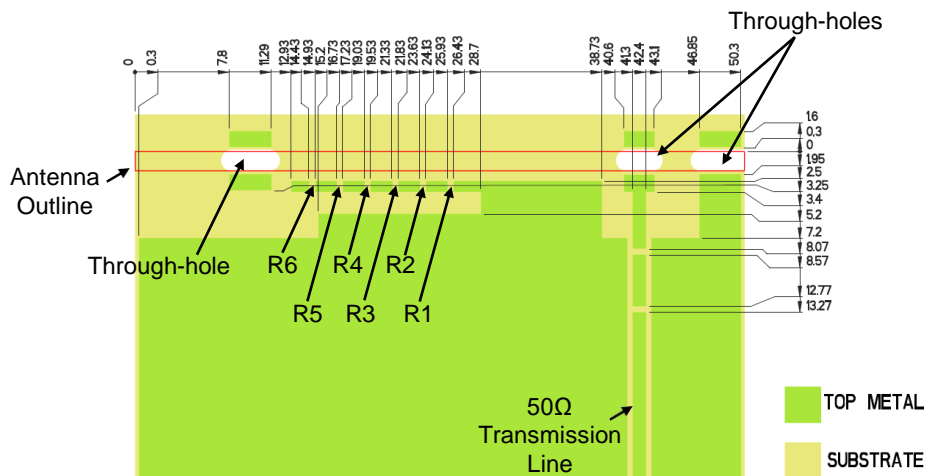

Default Pi Matching Network values and (R1- R6) tuning instructions can be found under Antenna Matching Structure.

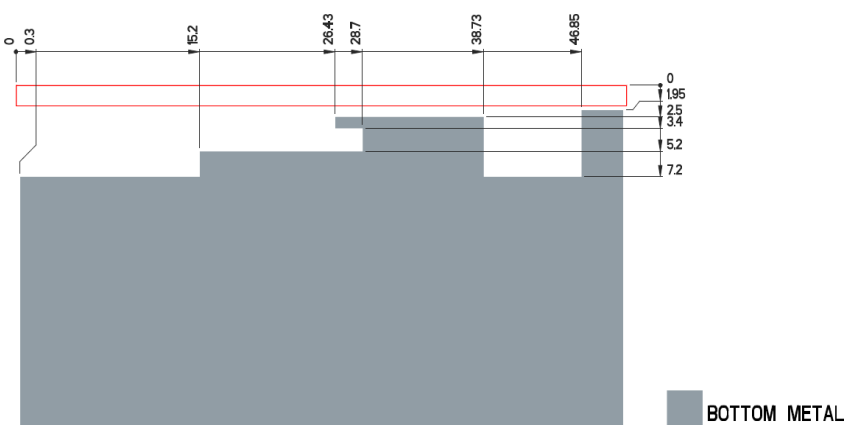
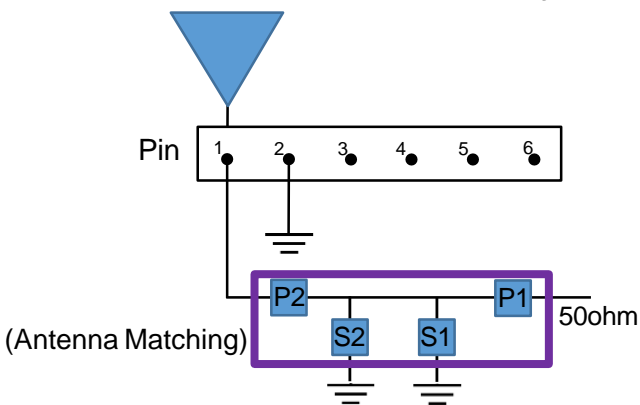

Broadband LTE Embedded KYOCERA AVX FR4 Antenna.
KYOCERA AVX produces a wide variety of standard and custom antennas to meet user needs.

Antenna Matching Structure

Typical matching values on 50 x 120 mm PCB

Demo Board Front View

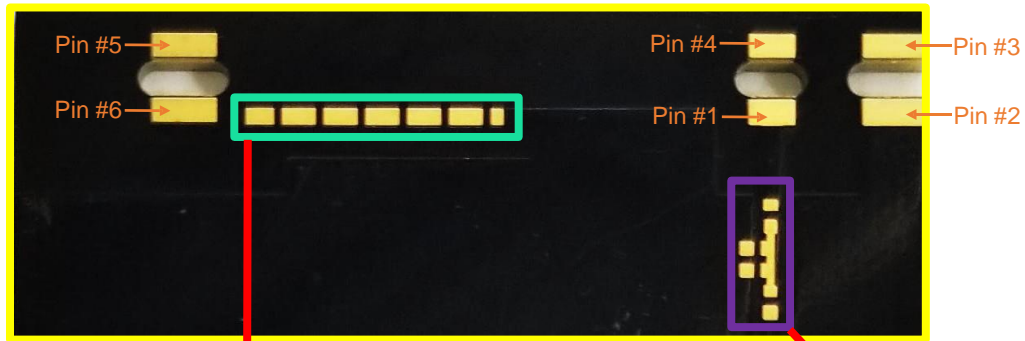

Low Band Tuning

Antenna Matching

Tune Low Band Higher
(Unpopulate Pads)

Tune Low Band Lower
(Add 0Ω)

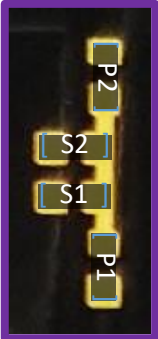

Pin Descriptions

Pin#	Description
1	Feed
2	Ground
3	Dummy Pad
4	Dummy Pad
5	Dummy Pad
6	Low Band Tuning

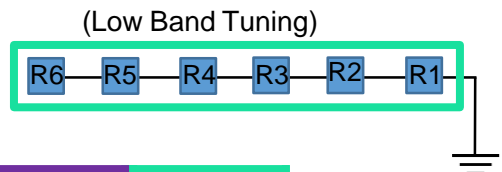
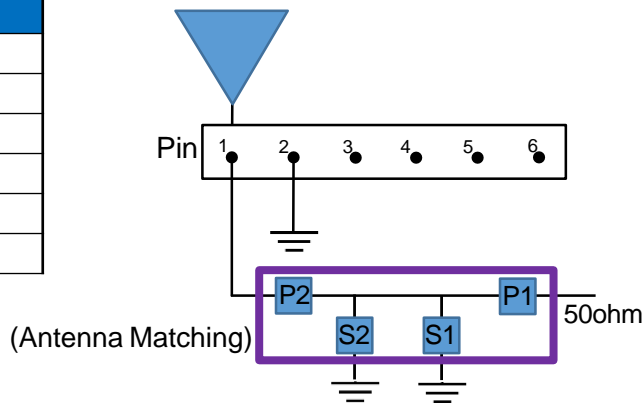

	P1	S1	S2	P2	(R1 - R6)
Default Matching	6.8pF	22nH	DNI	0Ω	DNI
Tolerance	±0.1pF	± 5%	N/A	N/A	N/A

Broadband LTE Embedded KYOCERA AVX FR4 Antenna.
 KYOCERA AVX produces a wide variety of standard and custom antennas to meet user needs.

Antenna Demo Board

Demo Board Front/Back View

Part Number	A	B
1002436-01	120	50



Front View

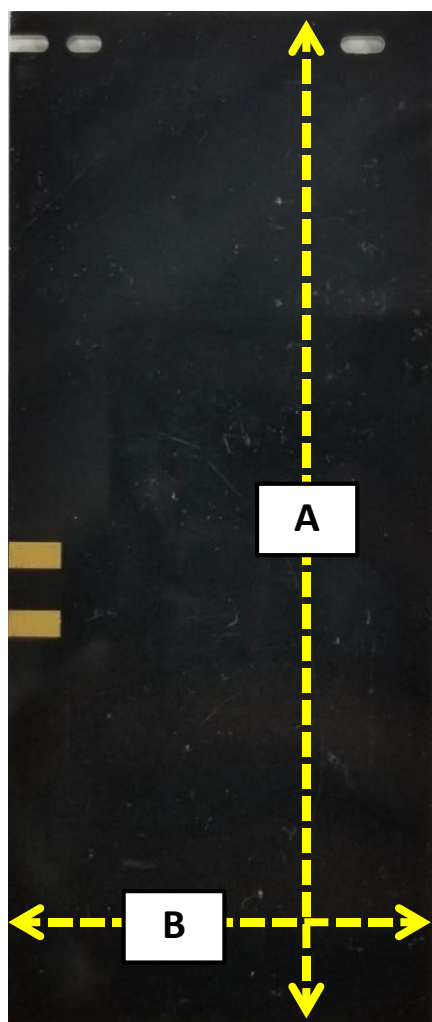

Back View