

REVISION AA

DO NOT SCALE FROM THIS PRINT

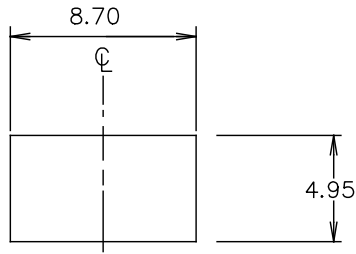

SUGGESTED PANEL CUTOUT DIMENSIONS

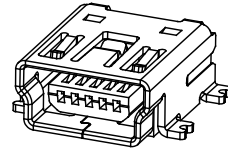

MUSB-05-X-B-SM-A-X-XX

- NO. OF CONTACTS \_\_\_\_\_
- 05 \_\_\_\_\_
- PLATING \_\_\_\_\_
  - F: 1 μ" FLASH GOLD ON CONTACT AREA, BRIGHT ACID TIN ON TAIL
  - S: 30 μ" SELECTIVE GOLD ON CONTACT AREA, BRIGHT ACID TIN ON TAIL
- OPTION \_\_\_\_\_
  - TR: TAPE & REEL PACKAGING (LEAVE BLANK FOR TRAY PACKAGING)
  - K: KAPTON PAD
  - E & I OPTION \_\_\_\_\_
  - R: RoHS COMPLIANT
- ALIGNMENT PINS \_\_\_\_\_
- RA TERMINATION \_\_\_\_\_
- SM: SURFACE MOUNT
- TYPE \_\_\_\_\_
- B \_\_\_\_\_

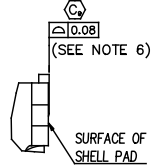
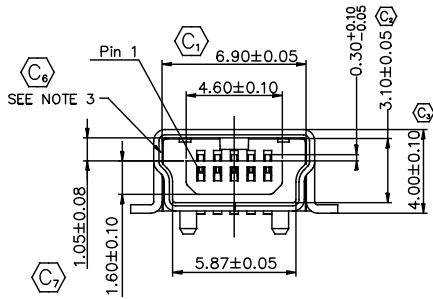
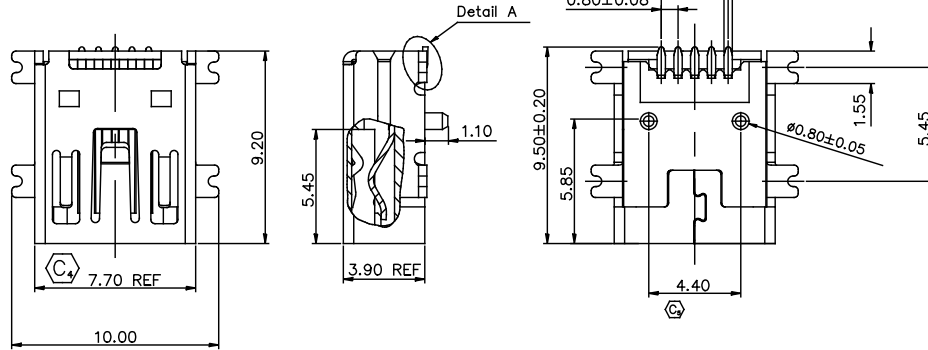

DETAIL A  
SCALE 2:1

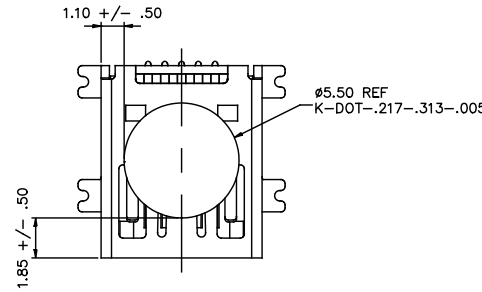

PAD PLACEMENT

NOTES:

1.  $\text{C}$  REPRESENTS CRITICAL DIMENSION.
2. NOTE DELETED.
3. CONFIRM THAT PARTS FACE MATCH THIS PRINT.
4. ALL PARTS RoHS COMPLIANT AS OF REVISION M.
5. PARTS TO BE PACKAGED LEADS DOWN IN TRAYS.
6. COPLANARITY MEASUREMENT SHOULD INCLUDED ALL USB TAILS AND SHELL TABS.

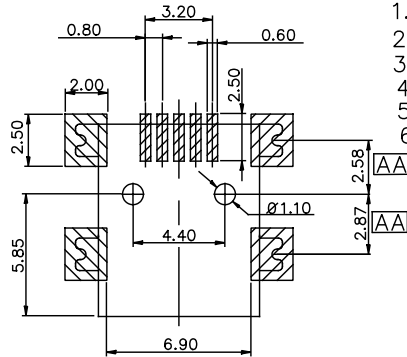

RECOMMENDED PCB LAYOUT

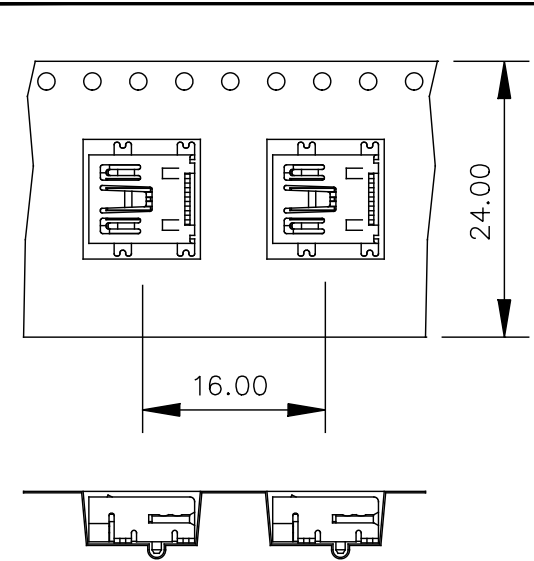

USER DIRECTION OF UNREELING →  
POCKET NOT DETAILED

-TR: TAPE & REEL OPTION

UNLESS OTHERWISE SPECIFIED, DIMENSIONS ARE IN MILLIMETERS TOLERANCES ARE:  
DECIMALS .X: ±.25 .XX: ±.13 .XXX: ±.05  
ANGLES 3°

PROPRIETARY NOTE  
THIS DOCUMENT CONTAINS CONFIDENTIAL AND PROPRIETARY INFORMATION AND ALL DESIGN, MANUFACTURING, REPRODUCTION, USE, PATENT RIGHTS AND SALES RIGHTS ARE EXPRESSLY RESERVED BY SAMTEC, INC. THIS DOCUMENT SHALL NOT BE DISCLOSED, IN WHOLE OR PART, TO ANY UNAUTHORIZED PERSON OR ENTITY NOR REPRODUCED, TRANSFERRED OR INCORPORATED IN ANY OTHER PROJECT IN ANY MANNER WITHOUT THE EXPRESS WRITTEN CONSENT OF SAMTEC, INC.

DO NOT SCALE DRAWING  
INSULATOR: LCP, RATED UL 94V-0, BLACK  
CONTACT: COPPER ALLOY  
SHELL: COPPER ALLOY

SHEET SCALE: 1:2

MAX FLASH ALLOWED: .051  
MAX GATE VESTIGE: .051  
F:\DWG\MISC\MKTG



520 PARK EAST BLVD. NEW ALBANY, IN 47150  
(812) 944-6733 P.O. BOX 1147 TWX: 810-540-4085

DESCRIPTION:  
Mini USB, RA, 5 Pin, Type B, Single, SMT

DWG. NO.  
MUSB-05-X-B-SM-A-X-XX

BY: J. WOOL 12/26/03 SHEET 1 OF 1

CODE: 55322