

CUSTOMER PRINT

PART NUMBER: 8380-XPG-5XX

- NOTES:
 1. ALL PARTS TO BE BULK PACKED
 2. CONTACTS SHIPPED UNASSEMBLED
 3. ALL DIMENSIONS ARE REFERENCE EXCEPT THOSE WITH A TOLERANCE

KIT P/N	GROMMET SIZE
8380-XPG-513	.148 GROMMET I.D. FOR CABLE O.D. .13-.15 [3.3-3.8mm]
8380-XPG-516	.176 GROMMET I.D. FOR CABLE O.D. .16-.18 [4.1-4.6mm]
8380-XPG-519	.206 GROMMET I.D. FOR CABLE O.D. .19-.21 [4.8-5.3mm]
8380-XPG-522	.245 GROMMET I.D. FOR CABLE O.D. .22-.25 [5.6-6.3mm]
8380-XPG-526	.265 GROMMET I.D. FOR CABLE O.D. .25-.27 [6.4-6.9mm]
8380-XPG-528	.280 GROMMET I.D. FOR CABLE O.D. .26-.285 [6.6-7.2mm]

KIT P/N	NO. OF CONTACTS
8380-2PG-5XX	2 #16
8380-3PG-5XX	3 #16
8380-4PG-5XX	4 #16
8380-5PG-5XX	5 #16
8380-XPG-5XX	

GROMMET SIZE

NO. OF CONTACTS

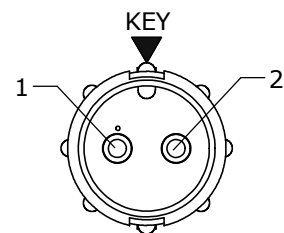

FACE VIEW
8380-2PG-5XX

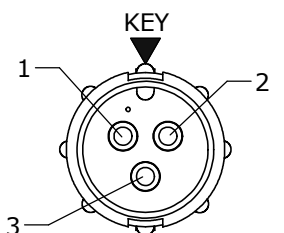

FACE VIEW
8380-3PG-5XX

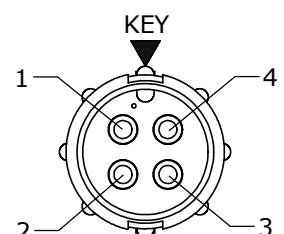

FACE VIEW
8380-4PG-5XX

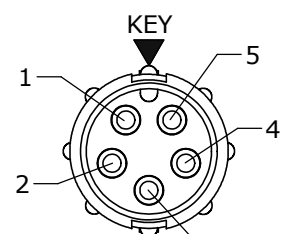

FACE VIEW
8380-5PG-5XX

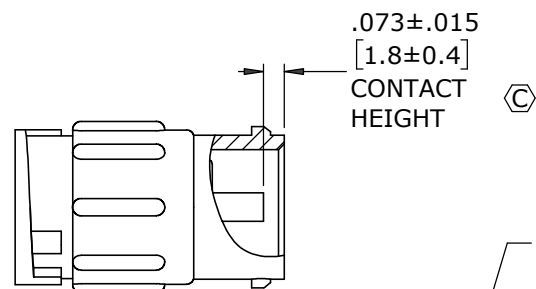

.073±.015
[1.8±0.4]
CONTACT HEIGHT

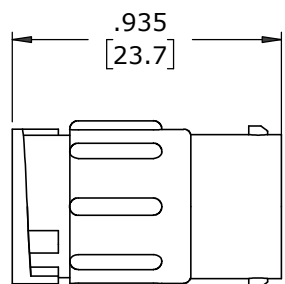

.935
[23.7]

(2-5) #16 PIN CONTACTS, CRIMP
MAT'L: GOLD PLATED
COPPER ALLOY



IN-LINE CONNECTOR, MALE
MAT'L: NYLON, BLACK

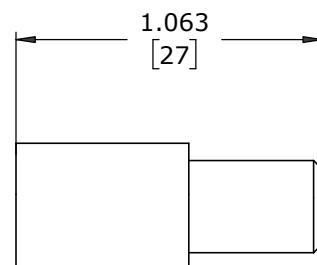

1.063
[27]

GROMMET
MAT'L: SANTOPRENE, BLACK

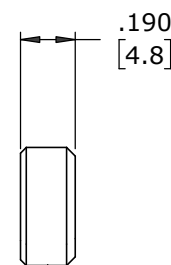

.190
[4.8]

CABLE GRIP
MAT'L: POLYPROPYLENE, BLACK

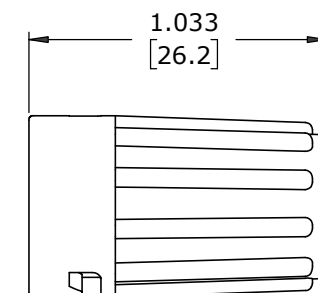

1.033
[26.2]

BACKSHELL
MAT'L: NYLON, BLACK

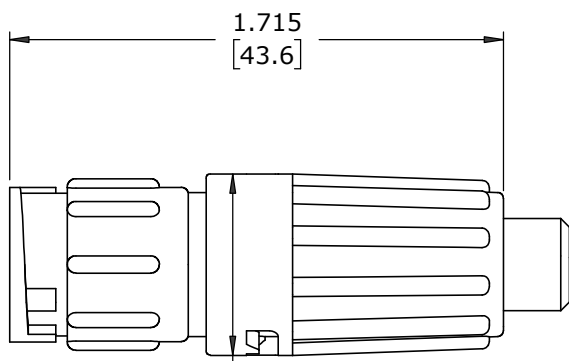

1.715
[43.6]

Ø.630
[16]

ASSEMBLED VIEW
FOR CUSTOMER REF.

DIMENSIONS IN BRACKETS [] ARE IN MILLIMETERS

CUSTOMER APPROVAL

THIS DOCUMENT CONTAINS CONFIDENTIAL INFORMATION PROPRIETARY TO CONXALL CORPORATION. ANY REPRODUCTION, DISCLOSURE, OR USE OF THIS DOCUMENT /INFORMATION IS EXPRESSLY PROHIBITED UNLESS AUTHORIZED IN WRITING BY CONXALL CORPORATION.

APPROVED BY: _____
 DATE: _____

REV.	INIT.	DATE	DESCRIPTION
C	MA	02-16-21	ADDED P/N 8380-XPG-526 AND CONTACT HEIGHT VIEW PER ECR 9544. STANDARDIZED DRAWING
B	PAK	01-24-13	ADDED P/N 8380-XPG-528 FOR .280 CABLE DIA. PER DOR 12-5009TC
A	AN	08-02-12	DRAWING CREATED PER DOR 12-E149SL #20

ALL INFORMATION ILLUSTRATED IS THE PROPERTY OF "CONXALL CORPORATION". UNAUTHORIZED DUPLICATION OR DISTRIBUTION OF THIS DOCUMENT IS PROHIBITED.	ORIG. DRAWN BY: AN DATE: 07-30-12	
ALL UNITS ARE IN FEET, INCHES, FRACTIONS OF INCHES AND DECIMALS.	CHECKED BY:	
APPROVED BY:	SCALE: NTS SIZE: B SHEET: 1 OF 1	TITLE: CABLE TO CABLE CONNECTOR KIT (2-5) #16 PIN CONTACTS MINI-CON-X
FILE: 08-02-12	DIRECTORY: SLW	CUSTOMER: STANDARD PRODUCT
		PART NUMBER: 8380-XPG-5XX
		REV: c

RoHS COMPLIANT