

RONDA-REC-90-C

~80° rectangular beam with holder C compatible with LEDiL HEKLA

SPECIFICATION:

Dimensions	Ø 53.9 mm
Height	16.6 mm
Fastening	socket
ROHS compliant	yes ⓘ

MATERIALS:

Component	Type	Material	Colour	Finish
F15788_RONDA-REC-90	Single lens	PMMA	clear	
F15635_RONDA-HLD-C	Holder	PC	white	

ORDERING INFORMATION:

Quantities for one set:

Single lens	1
Holder	1





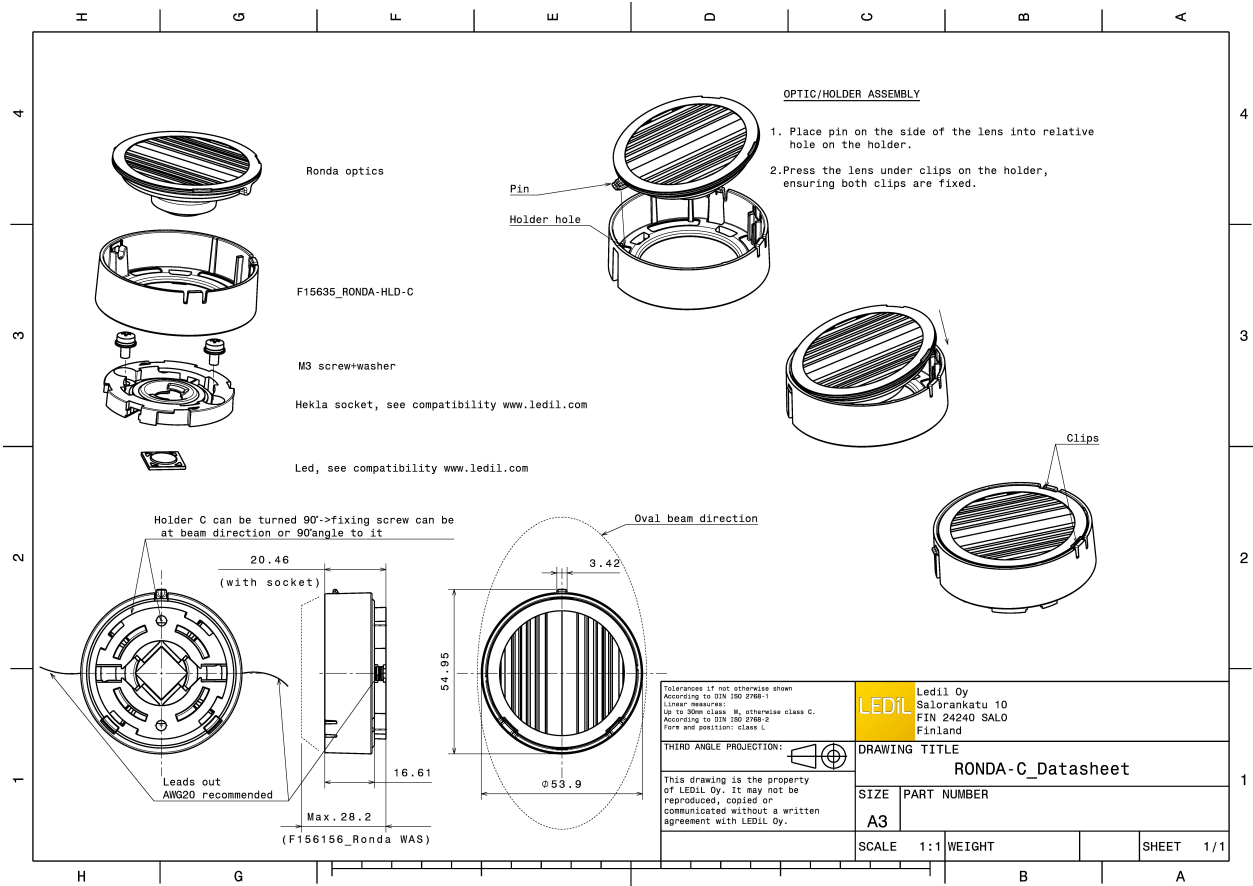





Component		Qty in box	MOQ	MPQ	Box weight (kg)
F15788_RONDA-REC-90	Single lens	420	120	30	6.5
» Box size: 480 x 280 x 300 mm					
F15635_RONDA-HLD-C	Holder	420	120	30	4.1
» Box size: 480 x 280 x 300 mm					

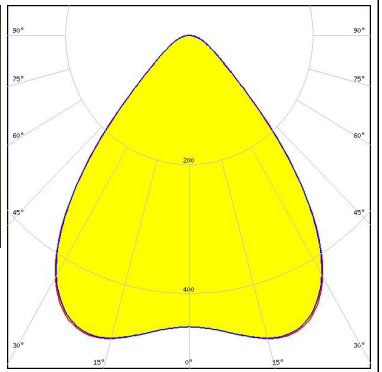

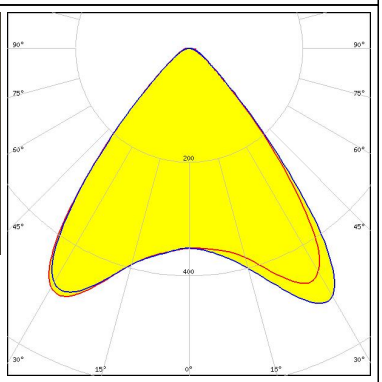

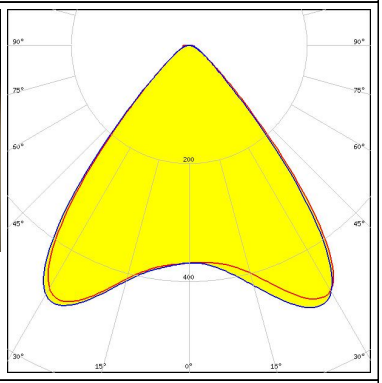

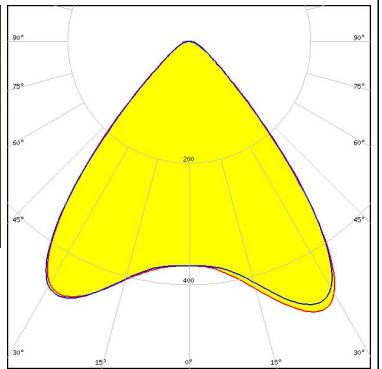

See also our general installation guide: www.ledil.com/installation_guide

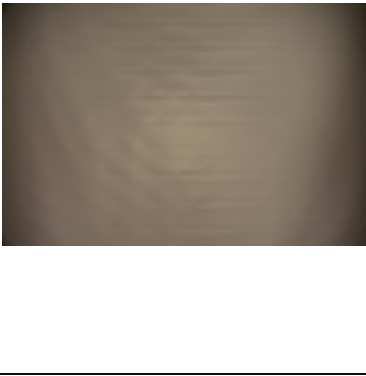
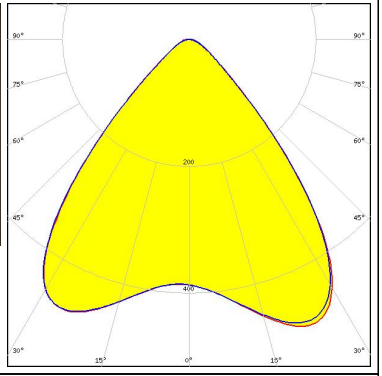

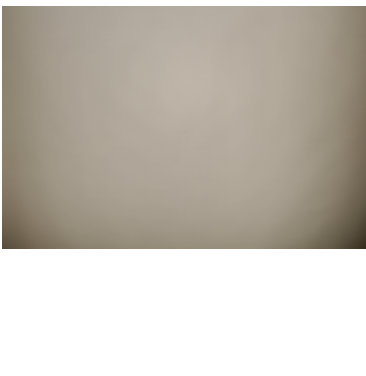
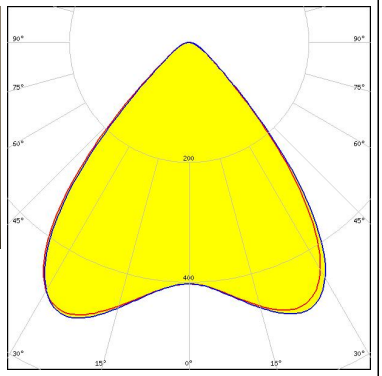
OPTICAL RESULTS (MEASURED):

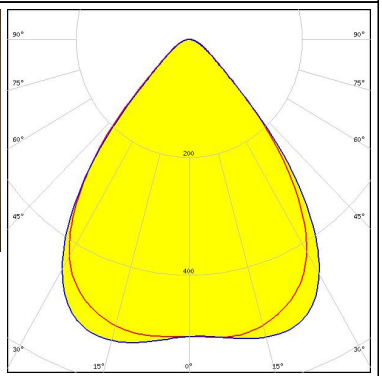
<p></p> <p>LED V11 HD Gen 8 FWHM / FWTM 81.0° / 115.0° Efficiency 89 % Peak intensity 0.5 cd/lm LEDs/each optic 1 Light colour White Required components: Bender Wirth: 633d Hekla</p>		
<p></p> <p>LED V4 HD Gen 7 FWHM / FWTM 85.0° / 114.0° Efficiency 92 % Peak intensity 0.7 cd/lm LEDs/each optic 1 Light colour White Required components: F15253_HEKLA-SOCKET-A</p>		
<p></p> <p>LED V6 Gen6 FWHM / FWTM 84.0° / 111.0° Efficiency 92 % Peak intensity 0.7 cd/lm LEDs/each optic 1 Light colour White Required components: F15253_HEKLA-SOCKET-A</p>		
<p></p> <p>LED V6 HD Gen 7 FWHM / FWTM 85.0° / 114.0° Efficiency 91 % Peak intensity 0.6 cd/lm LEDs/each optic 1 Light colour White Required components: F15255_HEKLA-SOCKET-C</p>		

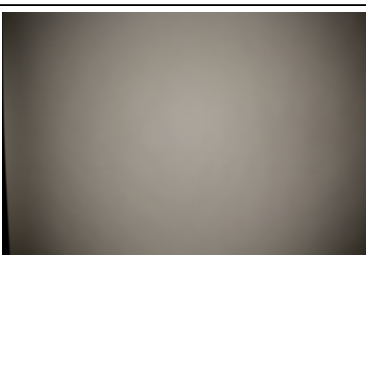
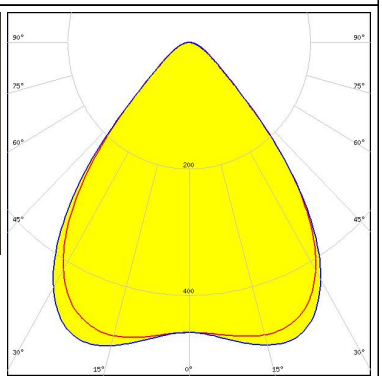
OPTICAL RESULTS (MEASURED):

<p></p> <p>LED V9 HD Gen7 FWHM / FWTM 85.0° / 115.0° Efficiency 89 % Peak intensity 0.6 cd/lm LEDs/each optic 1 Light colour White Required components: F15859_HEKLA-SOCKET-I</p>		
<p></p> <p>LED VERO10 FWHM / FWTM 85.0° / 111.0° Efficiency 90 % Peak intensity 0.6 cd/lm LEDs/each optic 1 Light colour White Required components: F15616_HEKLA-SOCKET-F</p>		
<p></p> <p>LED Vesta DTW 13mm (21W) FWHM / FWTM 80.0° / 109.0° Efficiency 84 % Peak intensity 0.5 cd/lm LEDs/each optic 1 Light colour Tunable White Required components: C16142_HEKLA-SOCKET-K Bender Wirth: 491 Typ L8</p>		
<p></p> <p>LED Vesta TW 13mm (25W) CSP FWHM / FWTM 82.0° / 114.0° Efficiency 85 % Peak intensity 0.5 cd/lm LEDs/each optic 1 Light colour White Required components: C16142_HEKLA-SOCKET-K Bender Wirth: 492 Typ L8</p>		

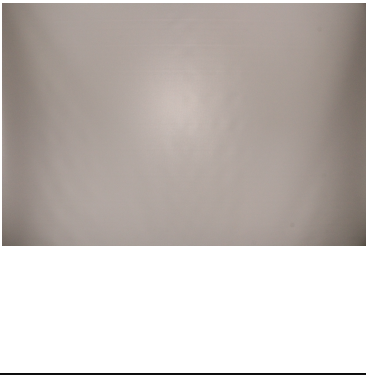
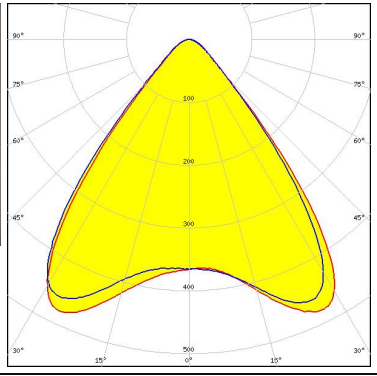
OPTICAL RESULTS (MEASURED):

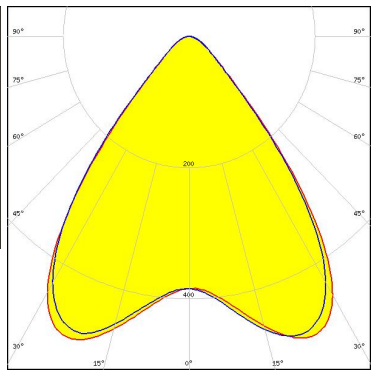
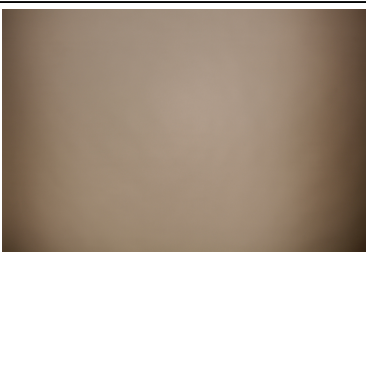
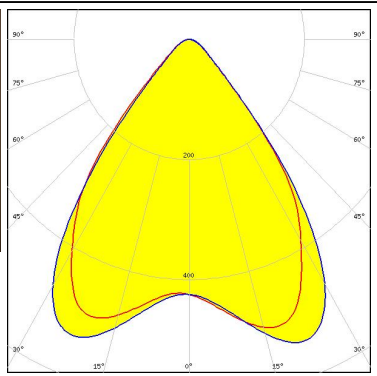
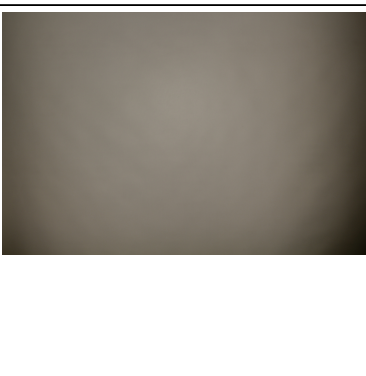
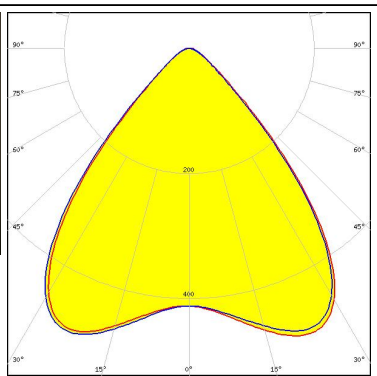
<p></p> <p>LED Vesta TW 6mm DP FWHM / FWTM 77.0° / 102.0° Efficiency 85 % Peak intensity 0.6 cd/lm LEDs/each optic 1 Light colour White Required components: C16142_HEKLA-SOCKET-K Bender Wirth: 504 Typ L8</p>		
<p></p> <p>LED Vesta TW 9mm (12W) CSP FWHM / FWTM 82.0° / 112.0° Efficiency 86 % Peak intensity 0.6 cd/lm LEDs/each optic 1 Light colour White Required components: C16142_HEKLA-SOCKET-K</p>		
<p>CITIZEN</p> <p>LED CLC020 Series (Dim-To-Warm) FWHM / FWTM 80.0° / 107.0 + 106.0° Efficiency 85 % Peak intensity 0.6 cd/lm LEDs/each optic 1 Light colour White Required components: C16142_HEKLA-SOCKET-K</p>		
<p>CITIZEN</p> <p>LED CLL02x/CLU02x (LES10) FWHM / FWTM 84.0° / 110.0° Efficiency 89 % Peak intensity 0.6 cd/lm LEDs/each optic 1 Light colour White Required components: F15255_HEKLA-SOCKET-C</p>		

OPTICAL RESULTS (MEASURED):

CITIZEN

LED CLU700/701/702/703
 FWHM / FWTM 83.0° / 111.0°
 Efficiency 90 %
 Peak intensity 0.6 cd/m
 LEDs/each optic 1
 Light colour White
 Required components:
 F15255_HEKLA-SOCKET-C

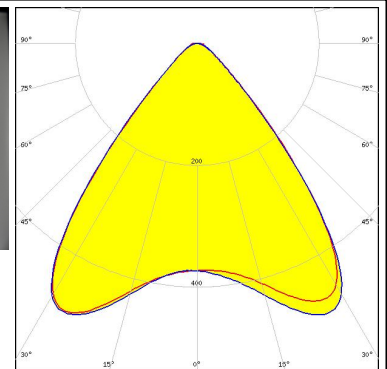

CITIZEN

LED LCN-C01B (Tunable White)
 FWHM / FWTM 81.0° / 113.0°
 Efficiency 86 %
 Peak intensity 0.6 cd/m
 LEDs/each optic 1
 Light colour White
 Required components:
 C16142_HEKLA-SOCKET-K
 Bender Wirth: 481 Typ L8

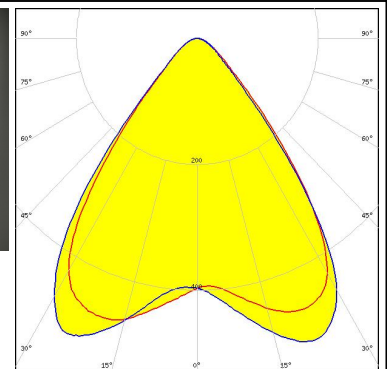
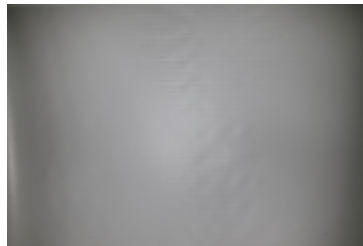

CREE LED

LED CMA1516
 FWHM / FWTM 86.0° / 115.0°
 Efficiency 92 %
 Peak intensity 0.5 cd/m
 LEDs/each optic 1
 Light colour White
 Required components:
 F15256_HEKLA-SOCKET-D

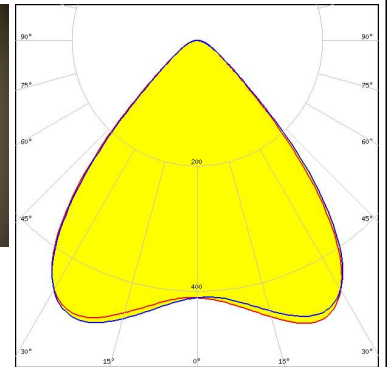
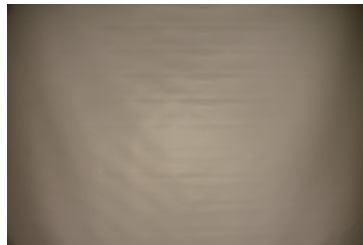

CREE LED

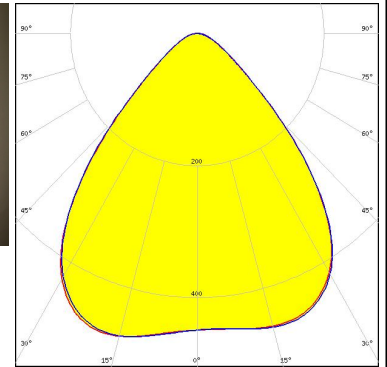

LED CMA1825
 FWHM / FWTM 86.0° / 121.0°
 Efficiency 90 %
 Peak intensity 0.5 cd/m
 LEDs/each optic 1
 Light colour White
 Required components:
 F15254_HEKLA-SOCKET-B

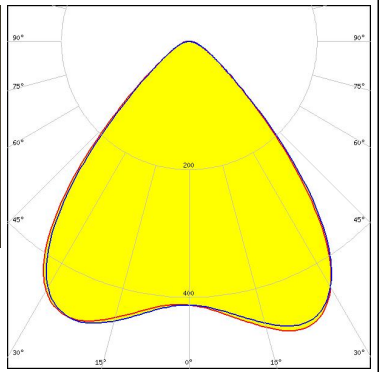
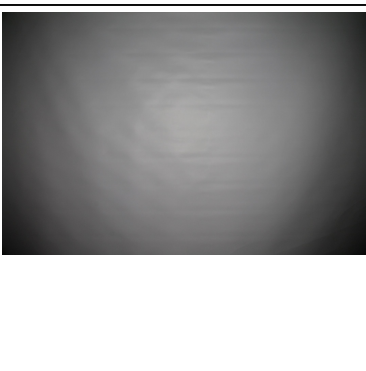
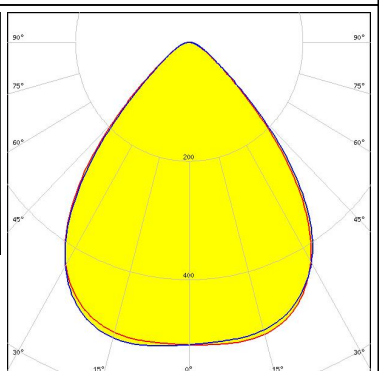
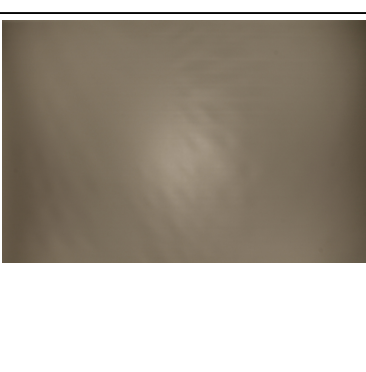
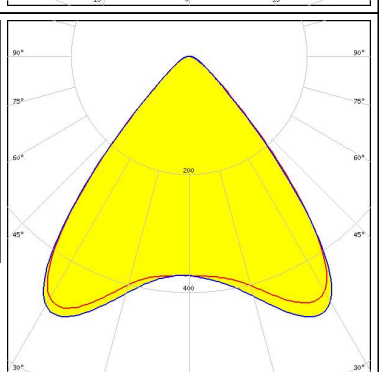
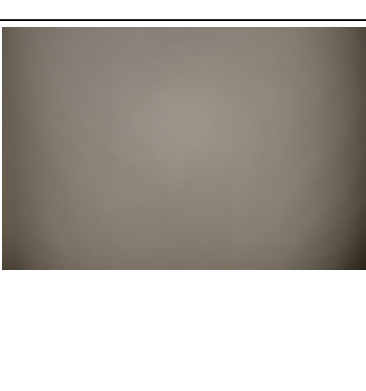
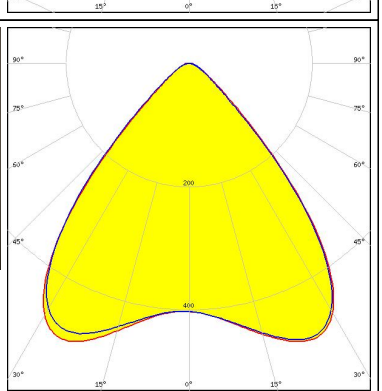

OPTICAL RESULTS (MEASURED):

<p>CREE → LED</p> <p>LED CMT14xx FWHM / FWTM 86.0° / 117.0° Efficiency 91 % Peak intensity 0.5 cd/m LEDs/each optic 1 Light colour White Required components: F15255_HEKLA-SOCKET-C</p>		
<p>CREE → LED</p> <p>LED CMT19xx FWHM / FWTM 82.0° / 114.0° Efficiency 88 % Peak intensity 0.5 cd/m LEDs/each optic 1 Light colour White Required components: F15859_HEKLA-SOCKET-I</p>		
<p>CREE → LED</p> <p>LED CXA/B 13xx FWHM / FWTM 84.0° / 110.0° Efficiency 91 % Peak intensity 0.6 cd/m LEDs/each optic 1 Light colour White Required components: F15956_HEKLA-SOCKET-J</p>		
<p>CREE → LED</p> <p>LED CXA/B 15xx FWHM / FWTM 85.0° / 111.0° Efficiency 91 % Peak intensity 0.6 cd/m LEDs/each optic 1 Light colour White Required components: F15256_HEKLA-SOCKET-D</p>		

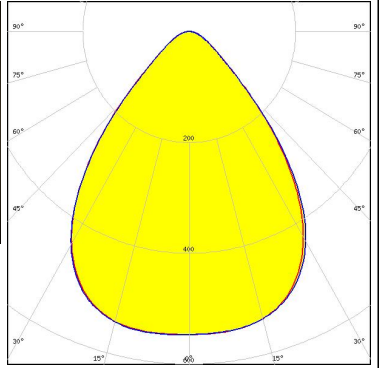
OPTICAL RESULTS (MEASURED):

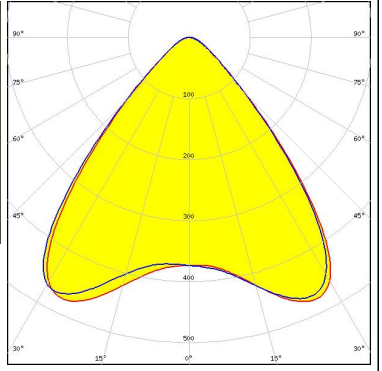
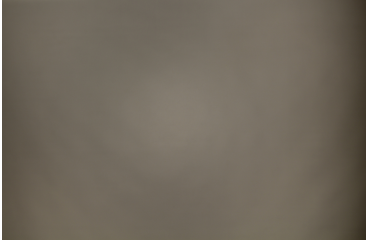
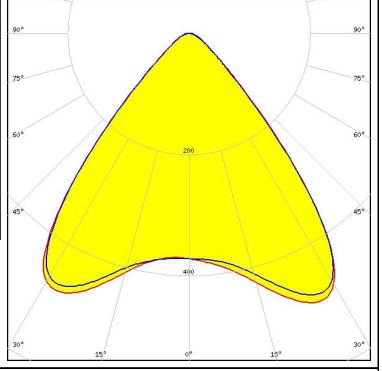
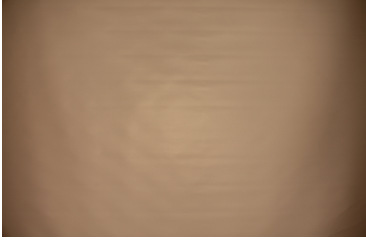
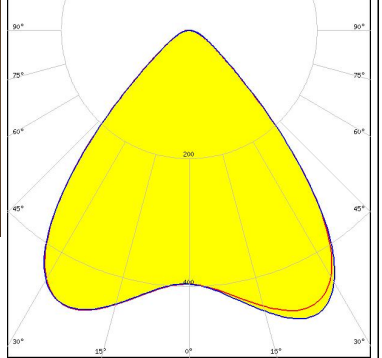
<p>LUMILEDS</p> <p>LED LUXEON CX Plus CoB L08 (Gen2)</p> <p>FWHM / FWTM 80.0° / 114.0°</p> <p>Efficiency 90 %</p> <p>Peak intensity 0.5 cd/lm</p> <p>LEDs/each optic 1</p> <p>Light colour White</p> <p>Required components: Bender Wirth: 637a Hekla</p>		
<p>LUMILEDS</p> <p>LED LUXEON CoB 1202HD</p> <p>FWHM / FWTM 85.2 + 85.4° / 116.3 + 116.5°</p> <p>Efficiency 91 %</p> <p>Peak intensity 0.6 cd/lm</p> <p>LEDs/each optic 1</p> <p>Light colour White</p> <p>Required components: F15848_HEKLA-SOCKET-G</p>		
<p>LUMILEDS</p> <p>LED LUXEON CoB 1202s</p> <p>FWHM / FWTM 84.0° / 112.0°</p> <p>Efficiency 91 %</p> <p>Peak intensity 0.6 cd/lm</p> <p>LEDs/each optic 1</p> <p>Light colour White</p> <p>Required components: F15848_HEKLA-SOCKET-G</p>		
<p>LUMILEDS</p> <p>LED LUXEON CoB 1204HD</p> <p>FWHM / FWTM 85.8 + 85.7° / 117.1 + 117.5°</p> <p>Efficiency 91 %</p> <p>Peak intensity 1.8 cd/lm</p> <p>LEDs/each optic 1</p> <p>Light colour White</p> <p>Required components: F15858_HEKLA-SOCKET-H</p>		

OPTICAL RESULTS (MEASURED):

LUMILEDS

LED LUXEON CoB 1205HD
 FWHM / FWTM 75.3 + 75.4° / 117.8 + 117.9°
 Efficiency 90 %
 Peak intensity 0.5 cd/lm
 LEDs/each optic 1
 Light colour White
 Required components:
 F15858_HEKLA-SOCKET-H

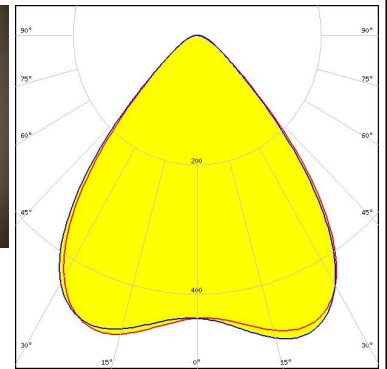
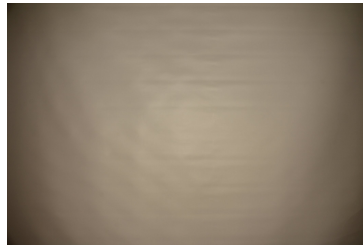

LUMILEDS

LED LUXEON CX Plus CoB - HD S01H4
 FWHM / FWTM 75.0° / 105.0°
 Efficiency 90 %
 Peak intensity 0.6 cd/lm
 LEDs/each optic 1
 Light colour White
 Required components:
 Bender Wirth: 634c Hekla

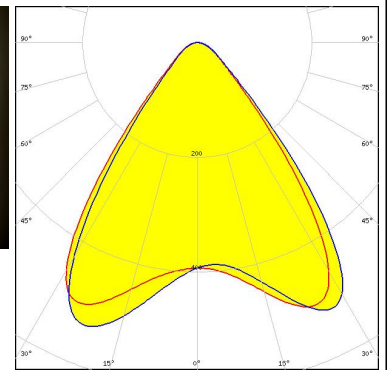
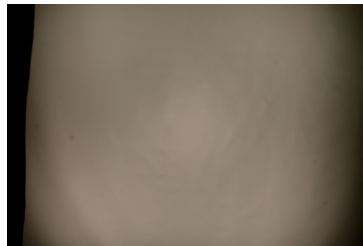

LUMILEDS

LED LUXEON CX Plus CoB - HD S01H6 / HD S02H6
 FWHM / FWTM 79.0° / 109.0°
 Efficiency 91 %
 Peak intensity 0.6 cd/lm
 LEDs/each optic 1
 Light colour White
 Required components:
 Bender Wirth: 634c Hekla

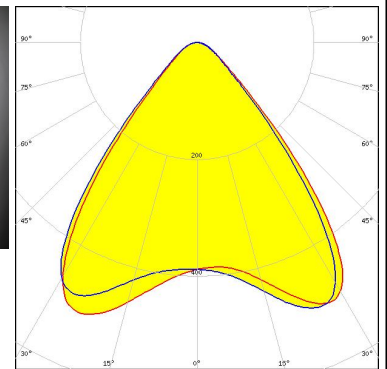



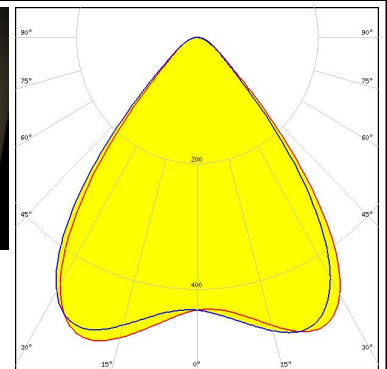

LUMILEDS

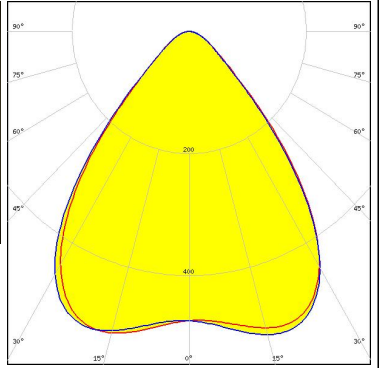

LED LUXEON CX Plus CoB - HD S04H9
 FWHM / FWTM 80.0° / 110.0°
 Efficiency 91 %
 Peak intensity 0.5 cd/lm
 LEDs/each optic 1
 Light colour White
 Required components:
 Bender Wirth: 634c Hekla

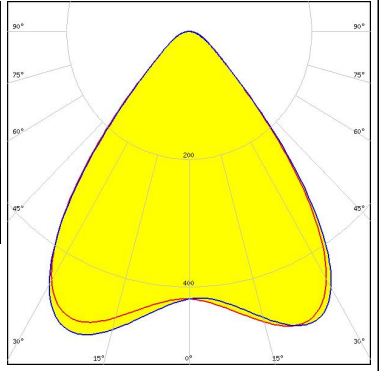
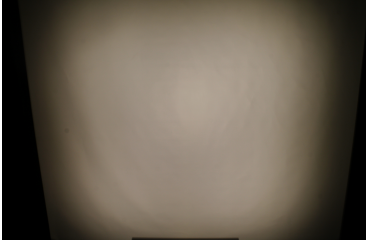
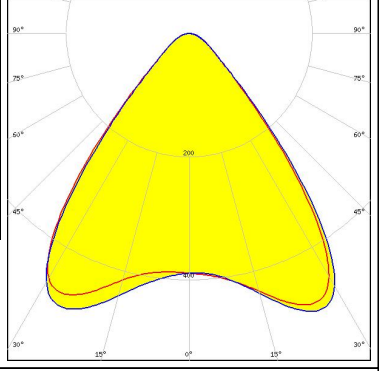

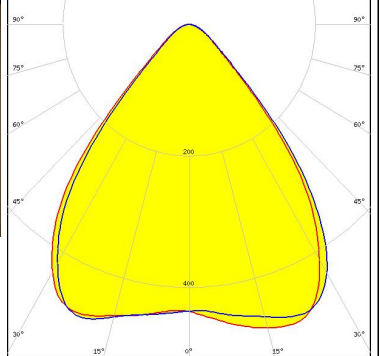

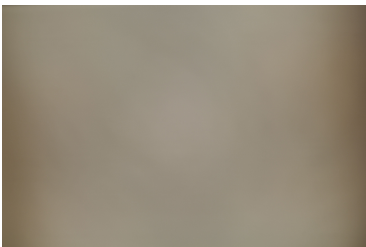
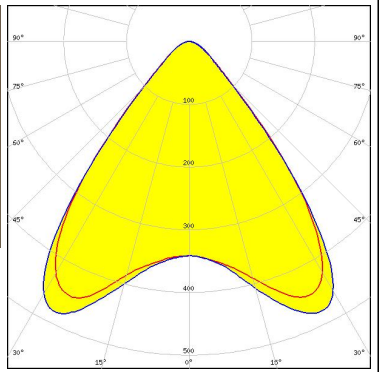

OPTICAL RESULTS (MEASURED):

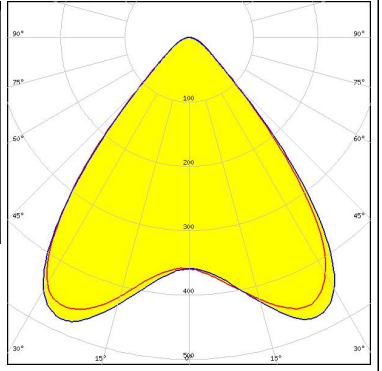
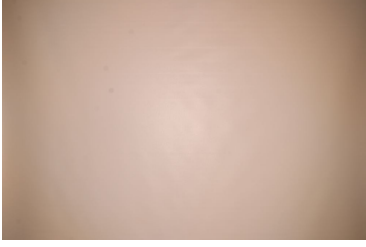
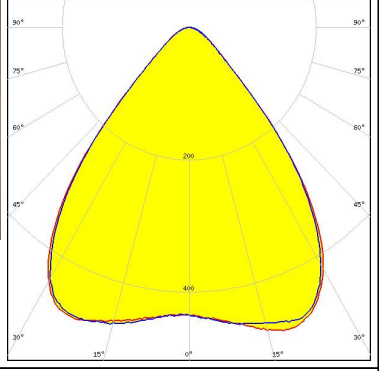
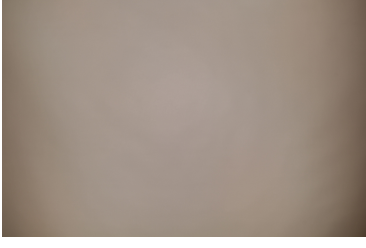
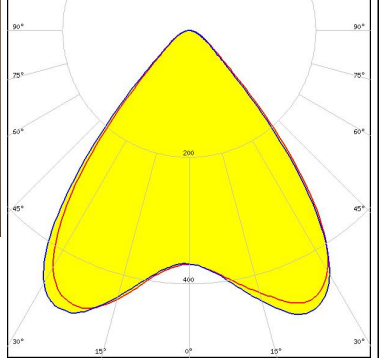
<p>LUMILEDS</p> <p>LED LUXEON CX Plus CoB L04 / L05 (Gen2)</p> <p>FWHM / FWTM 80.0° / 113.0°</p> <p>Efficiency 91 %</p> <p>Peak intensity 0.5 cd/lm</p> <p>LEDs/each optic 1</p> <p>Light colour White</p> <p>Required components: Bender Wirth: 637a Hekla</p>		
<p>LUMILEDS</p> <p>LED LUXEON CX Plus CoB M02 / M03 (Gen2)</p> <p>FWHM / FWTM 79.0° / 110.0°</p> <p>Efficiency 91 %</p> <p>Peak intensity 0.6 cd/lm</p> <p>LEDs/each optic 1</p> <p>Light colour White</p> <p>Required components: Bender Wirth: 641a Hekla</p>		
<p>LUMILEDS</p> <p>LED LUXEON CX Plus CoB S01 (Gen2)</p> <p>FWHM / FWTM 78.0° / 108.0°</p> <p>Efficiency 91 %</p> <p>Peak intensity 0.6 cd/lm</p> <p>LEDs/each optic 1</p> <p>Light colour White</p> <p>Required components: Bender Wirth: 634c Hekla</p>		
<p>LUMINUS</p> <p>LED CDM-14 (Dim-To-Warm)</p> <p>FWHM / FWTM 83.0° / 113.0°</p> <p>Efficiency 82 %</p> <p>Peak intensity 0.5 cd/lm</p> <p>LEDs/each optic 1</p> <p>Light colour White</p> <p>Required components: C16142_HEKLA-SOCKET-K Bender Wirth: 491 Typ L8</p>		

OPTICAL RESULTS (MEASURED):

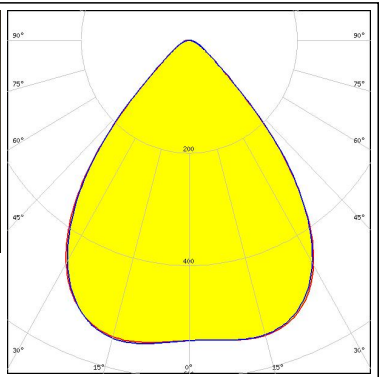
<p>LUMINUS</p> <p>LED CDM-6 (Dim-To-Warm)</p> <p>FWHM / FWTM 82.0° / 115.0°</p> <p>Efficiency 86 %</p> <p>Peak intensity 0.6 cd/lm</p> <p>LEDs/each optic 1</p> <p>Light colour White</p> <p>Required components: C16142_HEKLA-SOCKET-K Bender Wirth: 490 Typ L8</p>		
<p>LUMINUS</p> <p>LED CDM-9 (Dim-To-Warm)</p> <p>FWHM / FWTM 83.0° / 113.0°</p> <p>Efficiency 86 %</p> <p>Peak intensity 0.6 cd/lm</p> <p>LEDs/each optic 1</p> <p>Light colour White</p> <p>Required components: C16142_HEKLA-SOCKET-K Bender Wirth: 490 Typ L8</p>		
<p>LUMINUS</p> <p>LED CTM-14 (Tunable White)</p> <p>FWHM / FWTM 82.0° / 113.0°</p> <p>Efficiency 82 %</p> <p>Peak intensity 0.5 cd/lm</p> <p>LEDs/each optic 1</p> <p>Light colour White</p> <p>Required components: C16142_HEKLA-SOCKET-K Bender Wirth: 442 Typ L8</p>		
<p>LUMINUS</p> <p>LED CTM-9 (Tunable White)</p> <p>FWHM / FWTM 83.0° / 112.0°</p> <p>Efficiency 86 %</p> <p>Peak intensity 0.6 cd/lm</p> <p>LEDs/each optic 1</p> <p>Light colour White</p> <p>Required components: C16142_HEKLA-SOCKET-K Bender Wirth: 495 Typ L8</p>		

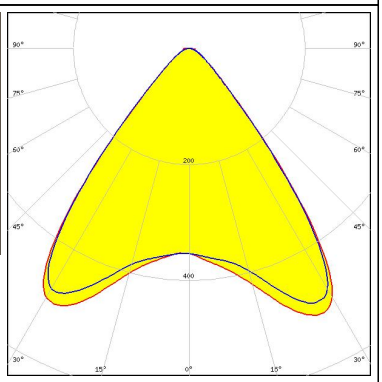
OPTICAL RESULTS (MEASURED):

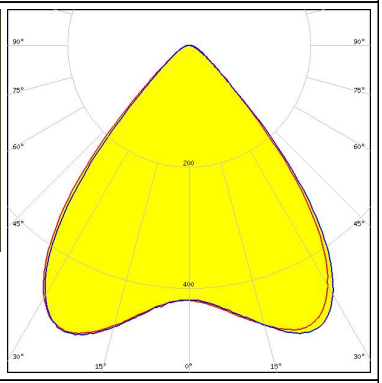
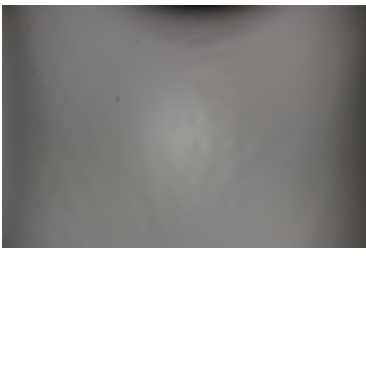
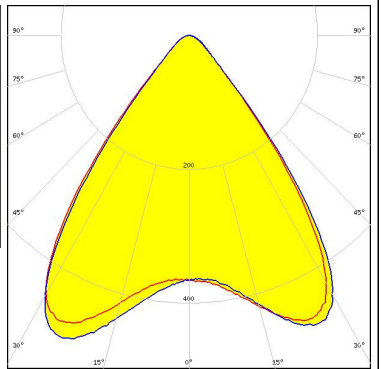
<p>LUMINUS</p> <p>LED CxM-14 (19x19) FWHM / FWTM 81.0° / 107.0° Efficiency 87 % Peak intensity 0.6 cd/lm LEDs/each optic 1 Light colour White Required components: F15859_HEKLA-SOCKET-I</p>		
<p>LUMINUS</p> <p>LED CXM-4 FWHM / FWTM 82.0° / 111.0° Efficiency 90 % Peak intensity 0.7 cd/lm LEDs/each optic 1 Light colour White Required components: F15255_HEKLA-SOCKET-C</p>		
<p>LUMINUS</p> <p>LED CxM-9 (13.5x13.5) FWHM / FWTM 83.0° / 108.0° Efficiency 90 % Peak intensity 0.6 cd/lm LEDs/each optic 1 Light colour White Required components: F15255_HEKLA-SOCKET-C</p>		
<p>NICHIA</p> <p>LED NJCWL024Z-V1MT: COB L-Type Tunable White FWHM / FWTM 84.0° / 108.0° Efficiency 83 % Peak intensity 0.6 cd/lm LEDs/each optic 1 Light colour White Required components: C16142_HEKLA-SOCKET-K Bender Wirth: 497 Typ L8</p>		

OPTICAL RESULTS (MEASURED):



LED NVCWJ024Z-V1MT: COB J-Type Tunable White
 FWHM / FWTM 84.0° / 109.0°
 Efficiency 87 %
 Peak intensity 0.6 cd/lm
 LEDs/each optic 1
 Light colour White
 Required components:
 C16142_HEKLA-SOCKET-K
 Bender Wirth: 498 Typ L8

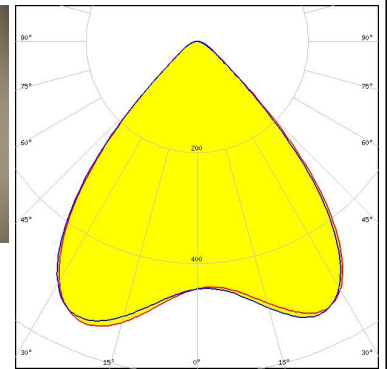

LED Fortimo SLM L09 CoB
 FWHM / FWTM 85.0° / 116.0°
 Efficiency 90 %
 Peak intensity 0.5 cd/lm
 LEDs/each optic 1
 Light colour White
 Required components:
 F15858_HEKLA-SOCKET-H

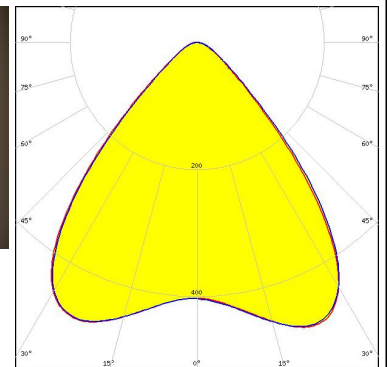
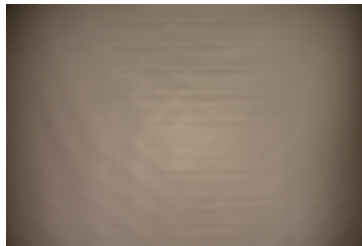

LED Fortimo SLM L13 CoB
 FWHM / FWTM 78.0° / 113.0°
 Efficiency 86 %
 Peak intensity 0.5 cd/lm
 LEDs/each optic 1
 Light colour White
 Required components:
 C16142_HEKLA-SOCKET-K
 Bender Wirth: 432 Typ L8

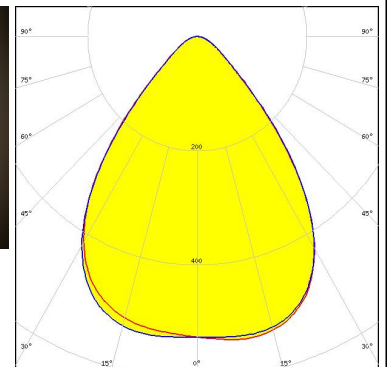
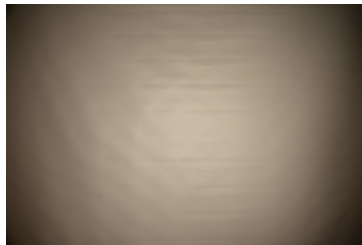

LED Fortimo SLM L13 CoB
 FWHM / FWTM 78.0° / 114.0°
 Efficiency 86 %
 Peak intensity 0.5 cd/lm
 LEDs/each optic 1
 Light colour White
 Required components:
 C16142_HEKLA-SOCKET-K
 Bender Wirth: 432 Typ L8

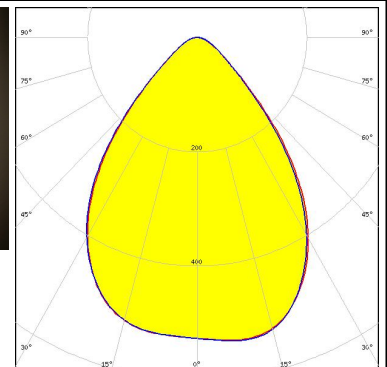
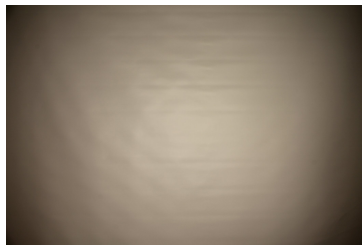

OPTICAL RESULTS (MEASURED):

SAMSUNG

LED LC003D / LC006D / LC009D / LC013D
 FWHM / FWTM 84.0° / 110.0°
 Efficiency 91 %
 Peak intensity 0.6 cd/m
 LEDs/each optic 1
 Light colour White
 Required components:
 F15255_HEKLA-SOCKET-C

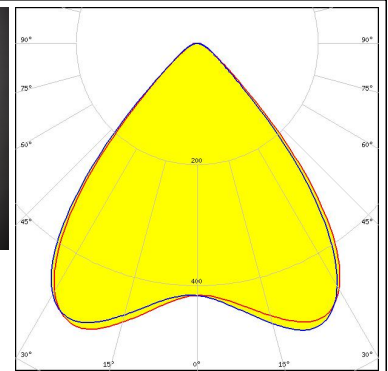

SAMSUNG

LED LC010C
 FWHM / FWTM 85.0° / 113.0°
 Efficiency 90 %
 Peak intensity 0.6 cd/m
 LEDs/each optic 1
 Light colour White
 Required components:
 F15848_HEKLA-SOCKET-G

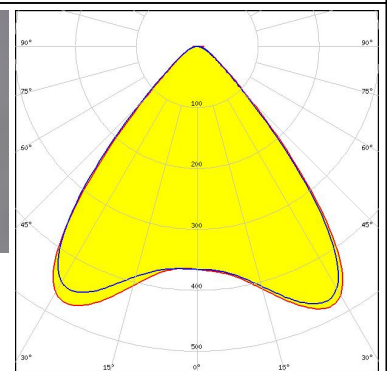

SAMSUNG

LED LC010C G2
 FWHM / FWTM 82.0° / 109.0°
 Efficiency 90 %
 Peak intensity 0.7 cd/m
 LEDs/each optic 1
 Light colour White
 Required components:
 F15255_HEKLA-SOCKET-C

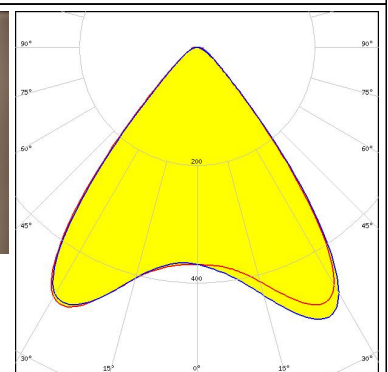

SAMSUNG

LED LC010T (Tunable White)
 FWHM / FWTM 78.0° / 104.0°
 Efficiency 87 %
 Peak intensity 0.6 cd/m
 LEDs/each optic 1
 Light colour Tunable White
 Required components:
 C16142_HEKLA-SOCKET-K
 Bender Wirth: 501 Typ L8

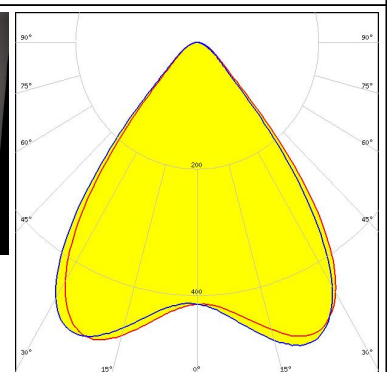

OPTICAL RESULTS (MEASURED):

SAMSUNG

LED LC016D / LC019D / LC026D / LC033D
 FWHM / FWTM 81.0° / 110.0°
 Efficiency 87 %
 Peak intensity 0.5 cd/lm
 LEDs/each optic 1
 Light colour White
 Required components:
 F15859_HEKLA-SOCKET-I

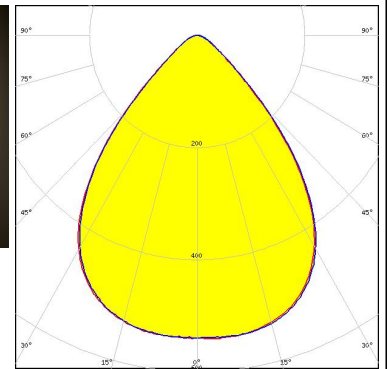
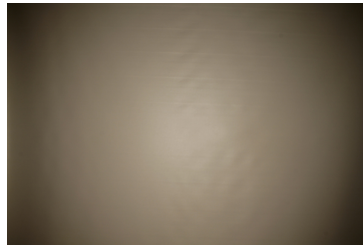

SAMSUNG

LED LC020C
 FWHM / FWTM 85.0° / 112.0 + 113.0°
 Efficiency 91 %
 Peak intensity 0.6 cd/lm
 LEDs/each optic 1
 Light colour White
 Required components:
 F15848_HEKLA-SOCKET-G

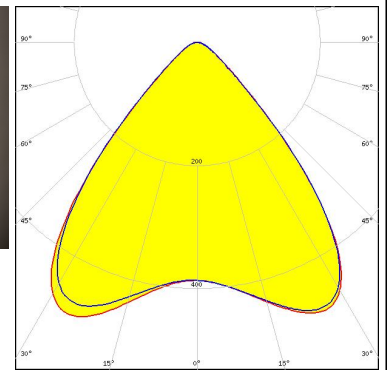
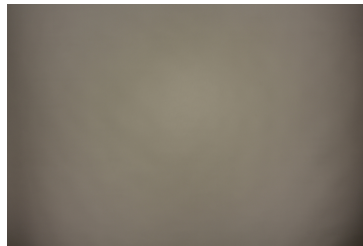

SAMSUNG

LED LC020C G2
 FWHM / FWTM 80.0° / 105.0°
 Efficiency 89 %
 Peak intensity 0.6 cd/lm
 LEDs/each optic 1
 Light colour White
 Required components:
 F15859_HEKLA-SOCKET-I

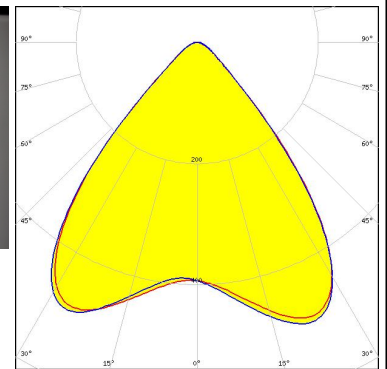



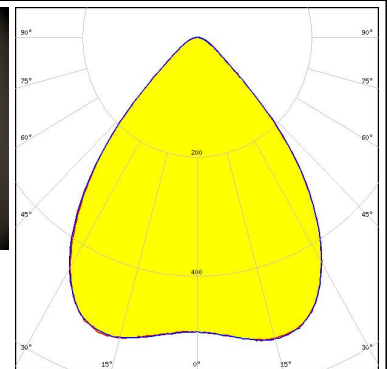
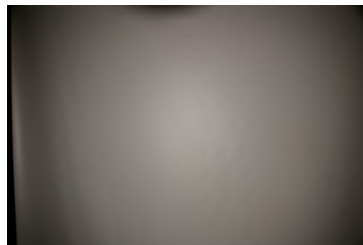

SAMSUNG

LED LC020T (Tunable white)
 FWHM / FWTM 81.0° / 109.0°
 Efficiency 86 %
 Peak intensity 0.5 cd/lm
 LEDs/each optic 1
 Light colour Tunable White
 Required components:
 C16142_HEKLA-SOCKET-K
 Bender Wirth: 501 Typ L8

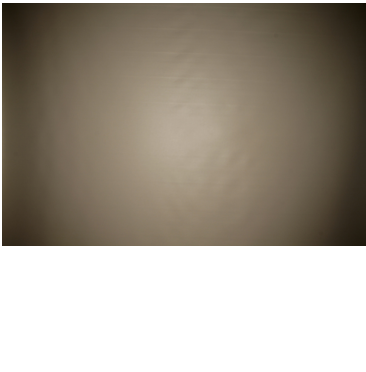
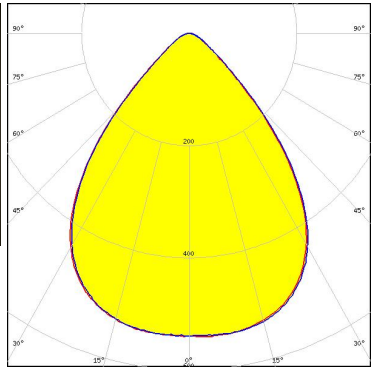
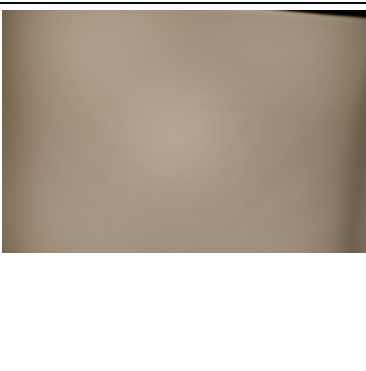
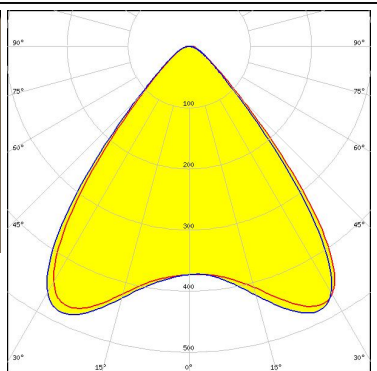

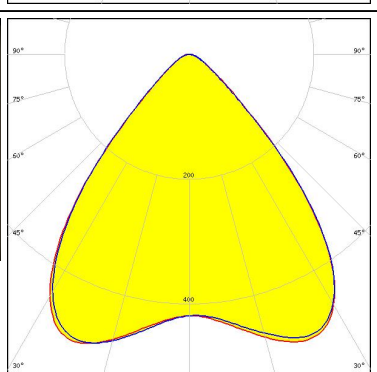
OPTICAL RESULTS (MEASURED):

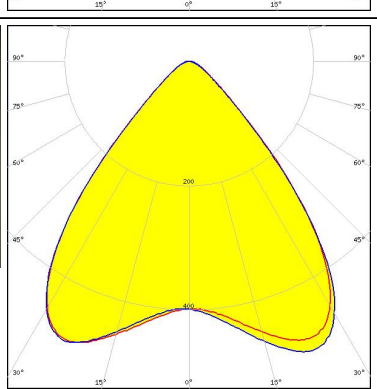
<p>SEOUL SEMICONDUCTOR</p> <p>LED MJT COB LES 14.5</p> <p>FWHM / FWTM 81.0° / 110.0°</p> <p>Efficiency 87 %</p> <p>Peak intensity 0.5 cd/m</p> <p>LEDs/each optic 1</p> <p>Light colour White</p> <p>Required components: F15859_HEKLA-SOCKET-I</p>		
<p>SEOUL SEMICONDUCTOR</p> <p>LED MJT COB LES 6</p> <p>FWHM / FWTM 83.0° / 113.0°</p> <p>Efficiency 89 %</p> <p>Peak intensity 0.6 cd/m</p> <p>LEDs/each optic 1</p> <p>Light colour White</p> <p>Required components: F15255_HEKLA-SOCKET-C</p>		
<p>SEOUL SEMICONDUCTOR</p> <p>LED MJT COB LES 9.8</p> <p>FWHM / FWTM 84.0° / 111.0°</p> <p>Efficiency 89 %</p> <p>Peak intensity 0.5 cd/m</p> <p>LEDs/each optic 1</p> <p>Light colour White</p> <p>Required components: F15255_HEKLA-SOCKET-C</p>		
<p>TRIDONIC</p> <p>LED SLE G7 LES09</p> <p>FWHM / FWTM 84.0° / 111.0°</p> <p>Efficiency 90 %</p> <p>Peak intensity 0.6 cd/m</p> <p>LEDs/each optic 1</p> <p>Light colour White</p> <p>Required components: F15255_HEKLA-SOCKET-C</p>		

OPTICAL RESULTS (MEASURED):

TRIDONIC

LED SLE G7 LES13
 FWHM / FWTM 84.0° / 112.0°
 Efficiency 87 %
 Peak intensity 0.5 cd/lm
 LEDs/each optic 1
 Light colour White
 Required components:
 F15859_HEKLA-SOCKET-I

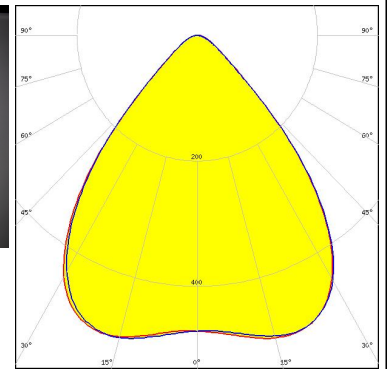

TRIDONIC

LED SLE G7 LES15
 FWHM / FWTM 81.0° / 112.0°
 Efficiency 87 %
 Peak intensity 0.5 cd/lm
 LEDs/each optic 1
 Light colour White
 Required components:
 F15859_HEKLA-SOCKET-I

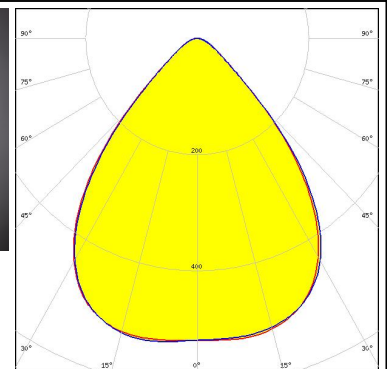
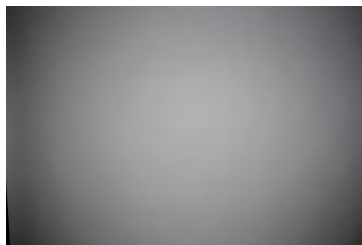

XICATO

LED XOB 14.5 mm
 FWHM / FWTM 82.0° / 110.0°
 Efficiency 87 %
 Peak intensity 0.5 cd/lm
 LEDs/each optic 1
 Light colour White
 Required components:
 F15859_HEKLA-SOCKET-I

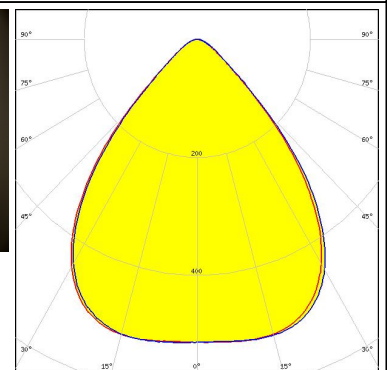
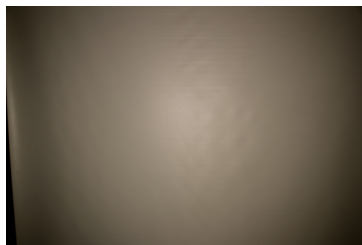

XICATO

LED XOB 9.8 mm
 FWHM / FWTM 80.0° / 106.0°
 Efficiency 90 %
 Peak intensity 0.6 cd/lm
 LEDs/each optic 1
 Light colour White
 Required components:
 F15255_HEKLA-SOCKET-C

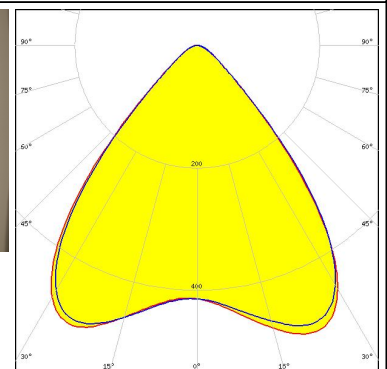

OPTICAL RESULTS (MEASURED):

XICATO

LED	XTM - 19mm LES
FWHM / FWTM	76.0° / 113.0°
Efficiency	87 %
Peak intensity	0.6 cd/lm
LEDs/each optic	1
Light colour	White
Required components:	
	C16058_XTM-ADAPTER-50-C

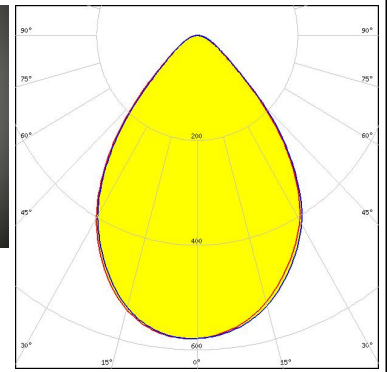

OPTICAL RESULTS (SIMULATED):



LED COB T-Type
FWHM / FWTM 68.0 + 74.0° / 83.0 + 89.0°
Efficiency 85 %
Peak intensity 0.7 cd/lm
LEDs/each optic 1
Light colour White
Required components:
F15848_HEKLA-SOCKET-G

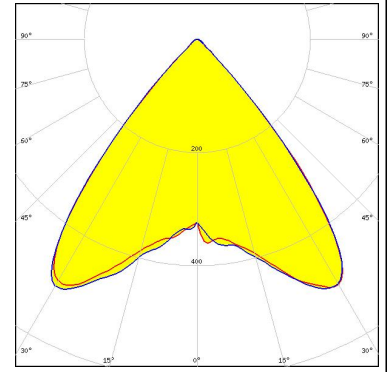

GENERAL INFORMATION:

NOTE: The typical beam angle will be changed by different color, chip size and chip position tolerance. The typical total beam angle is the full angle measured where the luminous intensity is half of the peak value.

Due to use of high power COB's with this product, special attention to proper thermal design is highly recommended. LEDiL has no liability for direct, indirect or consecutive damages arising from the LEDiL products being used outside of the recommended temperature range.

MATERIALS:

As part of our continuous research and improvement processes, and to ensure the best possible quality and availability of our products, LEDiL reserves the right to change material grades without notice.

PRODUCT DATA USER AGREEMENT AND DISCLAIMER:

The measured data in the provided downloadable LEDiL Product Datasheets and Mechanical 2D-Drawings is rounded and provided as reference for planning. LEDiL Oy's optical specifications have been verified by conducting performance testing of the products in accordance with the company's quality system. The reported data are averaged results of multiple measurements with typical variation. LEDiL Oy reserves the right to without prior notification make changes and improvements to its products.

LEDiL Oy assumes neither warranty, nor guarantee nor any other liability of any kind for the contents and correctness of the provided data. The provided data has been generated with highest diligence but the provided data may in reality not represent the complete possible variation range of all intrinsic parameters. Therefore, in certain cases a deviation from the provided data could occur.

LEDiL Oy reserves the right to undertake technical changes of its products without further notification which could lead to changes in the provided data. LEDiL Oy assumes no liability of any kind for the possible deviation from any provided data or any other damage resulting from the usage of the provided data.

The user agrees to this disclaimer and user agreement with the download or usage of the provided files.

LEDiL Oy

Joensuunkatu 13
FI-24240 SALO
Finland

LEDiL Inc.

228 West Page Street
Suite D
Sycamore IL 60178
USA

Ledil Optics Technology (Shenzhen) Co., Ltd.

405 , Block B
Casic Motor Building
Shenzhen 518057
P.R.CHINA

Local sales and technical support

[www.ledil.com/
where_to_buy](http://www.ledil.com/where_to_buy)

Shipping locations

Salo, Finland
Hong Kong, China

Distribution Partners

[www.ledil.com/
where_to_buy](http://www.ledil.com/where_to_buy)