



Distance sensor

VDM28-50-R-IO/73c/110/122



- Retroreflective laser distance sensor
- Measuring method PRT (Pulse Ranging Technology)
- Accurate, clear, and reproducible measuring results
- Red laser as the light emitter
- Version with laser class 2
- Version with IO-Link interface
- Version with analog output

Universal distance sensor, measurement to reflector, IO-Link interface, measuring method PRT, 50 m detection range, red laser light, laser class 2, push-pull output, analog output, M12 plug



Function

The VDM28 distance measurement device employs Pulse Ranging Technology (PRT). It has a repeat accuracy of 5 mm with an operating range of 0.2 ... 50 m and an absolute accuracy of 25 mm.

The compact housing of the Series 28 photoelectric sensors, with dimensions of 88 mm (height), 26 mm (width) and 54 mm (depth), make it the smallest device available in its class.

Dimensions

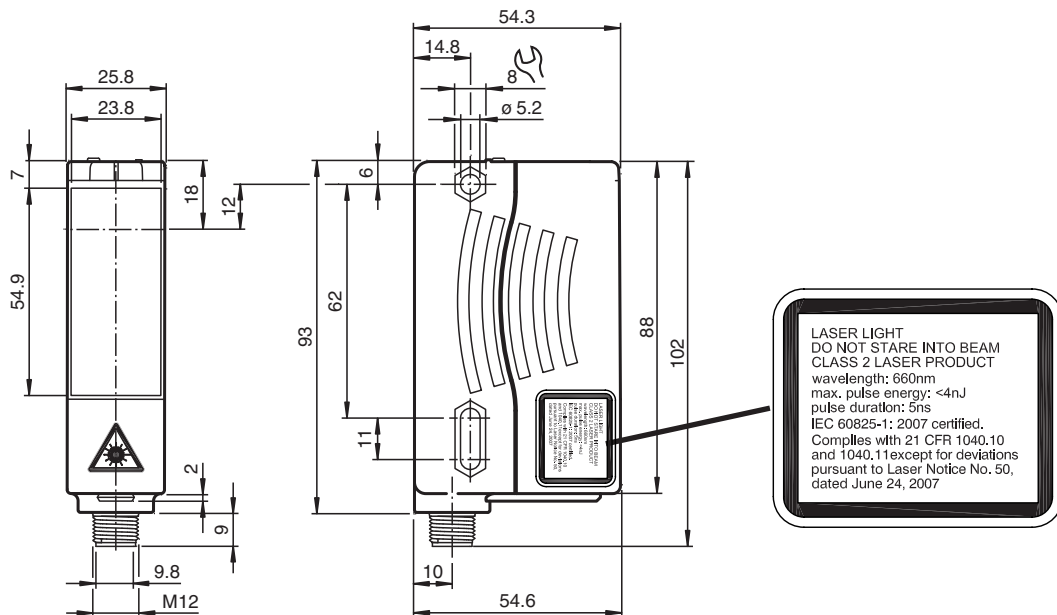

Release date: 2023-03-28 Date of issue: 2023-03-28 Filename: 223675_eng.pdf

Refer to "General Notes Relating to Pepperl+Fuchs Product Information".

Pepperl+Fuchs Group
 www.pepperl-fuchs.com

USA: +1 330 486 0001
 fa-info@us.pepperl-fuchs.com

Germany: +49 621 776 1111
 fa-info@de.pepperl-fuchs.com

Singapore: +65 6779 9091
 fa-info@sg.pepperl-fuchs.com

PF PEPPERL+FUCHS

Technical Data

General specifications		
Measurement range		0.2 ... 50 m
Reference target		OFR-100/100
Light source		laser diode typ. service life 85,000 h at Ta = +25 °C
Light type		modulated visible red light
Laser nominal ratings		
Note		LASER LIGHT , DO NOT STARE INTO BEAM
Laser class		2
Wave length		660 nm
Beam divergence		1 mrad
Pulse length		5 ns
Repetition rate		250 kHz
max. pulse energy		< 4 nJ
Angle deviation		max. ± 2°
Measuring method		Pulse Ranging Technology (PRT)
Diameter of the light spot		< 50 mm at a distance of 50 m at 20 °C
Ambient light limit		50000 Lux
Temperature influence		typ. ≤ 0.25 mm/K
Functional safety related parameters		
MTTF _d		200 a
Mission Time (T _M)		10 a
Diagnostic Coverage (DC)		0 %
Indicators/operating means		
Operation indicator		LED green
Function indicator		2 LEDs yellow for switching state
Teach-In indicator		Teach-In: LED green/yellow equiphase flashing; 2.5 Hz Teach Error: LED green/yellow non equiphase flashing; 8.0 Hz
Control elements		5-step rotary switch for operating modes selection (threshold setting and operating modes)
Control elements		Switch for setting the threshold values
Electrical specifications		
Operating voltage	U _B	10 ... 30 V DC / when operating in IO-Link mode: 18 ... 30 V
Ripple		10 % within the supply tolerance
No-load supply current	I ₀	≤ 70 mA / 24 V DC
Time delay before availability	t _v	1.5 s
Interface		
Interface type		IO-Link
Protocol		IO-Link V1.0
Cycle time		min. 2.3 ms
Mode		COM2 (38.4 kBit/s)
Process data width		16 bit
SIO mode support		yes
Output		
Signal output		Push-pull output, short-circuit protected, reverse polarity protected
Switching voltage		max. 30 V DC
Switching current		max. 100 mA
Measurement output		1 analog output 4 ... 20 mA, short-circuit/overload protected
Switching frequency	f	50 Hz
Response time		10 ms
Conformity		
Product standard		EN 60947-5-2
Laser safety		IEC 60825-1:2007
Measurement accuracy		

Release date: 2023-03-28 Date of issue: 2023-03-28 Filename: 223675_eng.pdf

Refer to "General Notes Relating to Pepperl+Fuchs Product Information".

 Pepperl+Fuchs Group
www.pepperl-fuchs.com

 USA: +1 330 486 0001
fa-info@us.pepperl-fuchs.com

 Germany: +49 621 776 1111
fa-info@de.pepperl-fuchs.com

 Singapore: +65 6779 9091
fa-info@sg.pepperl-fuchs.com

 **PEPPERL+FUCHS**

Technical Data

Absolute accuracy	± 25 mm
Repeat accuracy	< 5 mm
Approvals and certificates	
Protection class	II, rated voltage ≤ 250 V AC with pollution degree 1-2 according to IEC 60664-1
UL approval	cULus Listed, Class 2 Power Source, Type 1 enclosure
CCC approval	CCC approval / marking not required for products rated ≤36 V
FDA approval	IEC 60825-1:2007 Complies with 21 CFR 1040.10 and 1040.11 except for deviations pursuant to Laser Notice No. 50, dated June 24, 2007
Ambient conditions	
Ambient temperature	-30 ... 50 °C (-22 ... 122 °F)
Storage temperature	-30 ... 70 °C (-22 ... 158 °F)
Mechanical specifications	
Housing width	25.8 mm
Housing height	88 mm
Housing depth	54.6 mm
Degree of protection	IP65
Connection	4-pin, M12 x 1 connector
Material	
Housing	Plastic ABS
Optical face	PMMA
Mass	90 g

Connection Assignment

Option:

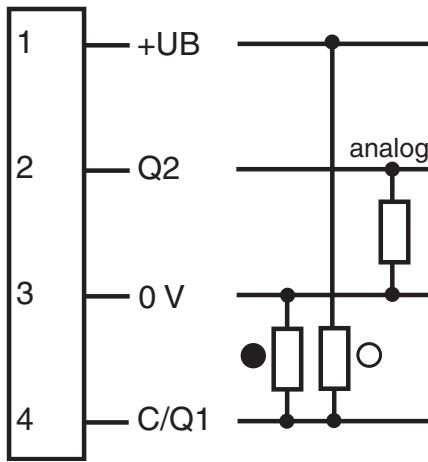

- = Light on
- = Dark on

Connection Assignment

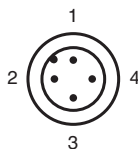

Release date: 2023-03-28 Date of issue: 2023-03-28 Filename: 223675_eng.pdf

Connection Assignment

Wire colors in accordance with EN 60947-5-2

- 1 | BN (brown)
- 2 | WH (white)
- 3 | BU (blue)
- 4 | BK (black)

Assembly

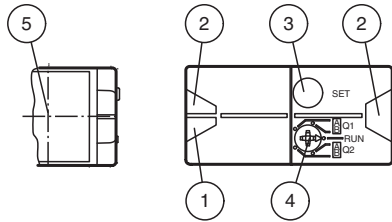

1	Operating display	green
2	Signal display	yellow
3	TEACH-IN button	
4	Mode rotary switch	
5	Laser output	

Application



Safety Information

LASER LIGHT
DO NOT STARE INTO BEAM
CLASS 2 LASER PRODUCT
WAVELENGTH: 660 nm
MAX PULSE ENERGY: < 4 nJ
PULSE DURATION: 5 ns
IEC 60825-1: 2007 CERTIFIED.
COMPLIES WITH 21 CFR 1040.10
AND 1040.11 EXCEPT FOR DEVIATIONS PURSUANT TO LASER NOTICE NO. 50, DATED JUNE 24, 2007.

LUMIÈRE LASER
NE PAS REGARDER LE FAISCEAU
PRODUIT LASER CLASSE 2
LONGUEUR D'ONDE: 660 nm
MAX. ÉNERGIE D'IMPULSION: < 4 nJ
DURÉE D'IMPULSION: 5 ns
CERTIFIÉ CEI 60825-1: 2007.
CONFORME AUX NORMES 21 CFR 1040.10 ET 1040.11 À L'EXCEPTION DES ÉCARTS CONFORMÉMENT À LA NOTICE DU LASER N° 50, DATEE DU 24 JUIN 2007.

Release date: 2023-03-28 Date of issue: 2023-03-28 Filename: 223675_eng.pdf

Refer to "General Notes Relating to Pepperl+Fuchs Product Information".

Safety Information

Laser Class 2 Information

The irradiation can lead to irritation especially in a dark environment. Do not point at people!



















Caution: Do not look into the beam!

Maintenance and repairs should only be carried out by authorized service personnel!

Attach the device so that the warning is clearly visible and readable.

Caution – Use of controls or adjustments or performance of procedures other than those specified herein may result in hazardous radiation exposure.

Accessories

	PACTware 4.1	FDT Framework
	OMH-05	Mounting aid for round steel \varnothing 12 mm or sheet 1.5 mm ... 3 mm
	OMH-07-01	Mounting aid for round steel \varnothing 12 mm or sheet 1.5 mm ... 3 mm
	OMH-21	Mounting bracket: mounting aid for sensors in the RL* series
	OMH-22	Mounting aid for RL* series
	OMH-VDM28-01	Metal enclosure for inserting protective panes or apertures
	OMH-VDM28-02	Mounting and fine adjustment device for sensors from the 28 series
	OMH-RLK29-HW	Mounting bracket for rear wall mounting
	OMH-RL28-C	Weld slag cover model
	OMH-K01	dove tail mounting clamp
	OMH-K03	dove tail mounting clamp
	OFR-100/100	Reflective tape 100 mm x 100 mm
	REF-MH82	Reflector with Micro-structure, rectangular 82 mm x 60 mm, mounting holes
	REF-MH50	Reflector with Micro-structure, rectangular 50.9 mm x 50.9 mm, mounting holes, fixing strap
	REF-MH78	Reflector with Micro-structure, hexagonal 78 mm x 61 mm, mounting holes
	V1-G-2M-PVC	Female cordset single-ended M12 straight A-coded, 4-pin, PVC cable grey
	V1-W-2M-PUR	Female cordset single-ended M12 angled A-coded, 4-pin, PUR cable grey
	V1-G-2M-PUR	Female cordset single-ended M12 straight A-coded, 4-pin, PUR cable grey

Release date: 2023-03-28 Date of issue: 2023-03-28 Filename: 223675_eng.pdf

Refer to "General Notes Relating to Pepperl+Fuchs Product Information".

Pepperl+Fuchs Group
www.pepperl-fuchs.com









USA: +1 330 486 0001
fa-info@us.pepperl-fuchs.com

Germany: +49 621 776 1111
fa-info@de.pepperl-fuchs.com

Singapore: +65 6779 9091
fa-info@sg.pepperl-fuchs.com

 **PEPPERL+FUCHS**

Accessories

	ICE2-8IOL-G65L-V1D	EtherNet/IP IO-Link master with 8 inputs/outputs
	ICE3-8IOL-G65L-V1D	PROFINET IO IO-Link master with 8 inputs/outputs
	ICE1-8IOL-G30L-V1D	Ethernet IO-Link module with 8 inputs/outputs
	ICE1-8IOL-G60L-V1D	Ethernet IO-Link module with 8 inputs/outputs
	ICE2-8IOL-K45P-RJ45	EtherNet/IP IO-Link master with 8 inputs/outputs, DIN rail, push-in connectors
	ICE2-8IOL-K45S-RJ45	EtherNet/IP IO-Link master with 8 inputs/outputs, DIN rail, screw terminal
	ICE3-8IOL-K45P-RJ45	PROFINET IO IO-Link master with 8 inputs/outputs, DIN rail, push-in terminals
	ICE3-8IOL-K45S-RJ45	PROFINET IO IO-Link master with 8 inputs/outputs, DIN rail, screw terminal
	IO-Link-Master02-USB	IO-Link master, supply via USB port or separate power supply, LED indicators, M12 plug for sensor connection
	OMH-VDM28-CID1	Protective enclosure

Teach-In

You can use the rotary switch to select the relevant switching threshold A and/or B for teaching in for switching output **Q1**. The yellow LEDs indicate the current state of the selected output.

To store a switching threshold (distance measured value), press and hold the "SET" button until the yellow and green LEDs flash in phase (approx. 2 s). Teach-In starts when the "SET" button is released.

Successful Teach-In is indicated by alternating flashing (2.5 Hz) of the yellow and green LEDs.

An unsuccessful Teach-In is indicated by rapidly alternating flashing (8 Hz) of the yellow and green LEDs.

After an unsuccessful Teach-In, the sensor continues to operate with the previous valid setting after the relevant visual fault signal is issued.

Different switching modes can be defined by teaching in the relevant distance measured values for the switching thresholds A and B:

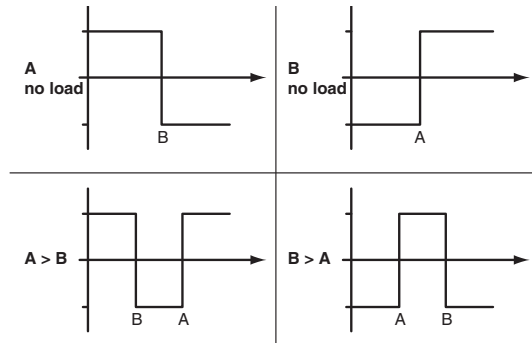

Every taught-in switching threshold can be retaught (overwritten) by pressing the SET button again.

Pressing and holding the "SET" button for > 5 s completely deletes the taught-in value. The yellow and green LEDs go out simultaneously to indicate that this procedure has been completed.

Minimum and maximum values for the analog output **Q2** are taught in in the same way as those for the switching output:

The following values apply: A = 4 mA
B = 20 mA

This provides three different options for operation:

A < B -> rising slope

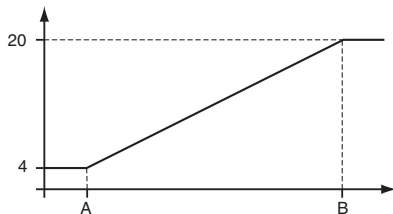

A > B -> falling slope

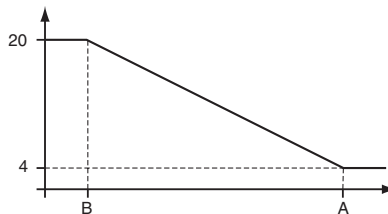

A empty -> zero start point

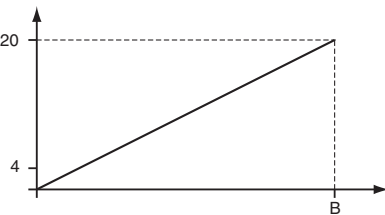

Reset to default settings:

Factory setting for switching output Q1:

- Switching output inactive

Factory setting for analog output Q2:

A = 200 mm

B = 5000 mm



Value B cannot be deleted

The "zero start point" operating mode can be obtained by deleting value A

- Set the rotary switch to the "RUN" position
- Press and hold the "SET" button until the yellow and green LEDs stop flashing in phase (approx. 10 s)
- When the green LED lights up continuously, the procedure is complete.

Error messages:

- Short circuit: In the event of a short circuit at the sensor output, the green LED flashes with a frequency of approx. 4 Hz.

Release date: 2023-03-28 Date of issue: 2023-03-28 Filename: 223675_eng.pdf

- Teach error: In the event of a teach error, the yellow and green LEDs flash alternately with a frequency of approx. 8 Hz.

**Note!**

The difference in the taught-in distance measured values for switching thresholds A and B must be greater than 20 mm.

If the difference in the taught-in measured values is the same as or smaller than the set switching hysteresis, the sensor will visually signal an unsuccessful Teach-In. The last distance measured value that was taught in will not be adopted by the sensor.

Select a new distance measured value for switching threshold A or B with a greater difference between the switching thresholds.

Teach in this distance measured value on the sensor again.

Switching threshold A can be deleted or set to a value of zero.

(E.g., when setting the "zero start point" curve).

However, switching threshold B can neither be deleted nor set to a value of zero.