

N-channel 800 V, 0.55 Ω typ., 8 A MDmesh™ K5 Power MOSFET in a I²PAKFP package

Datasheet - production data

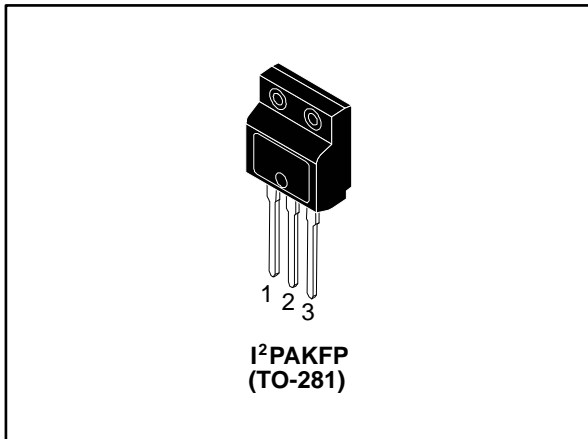
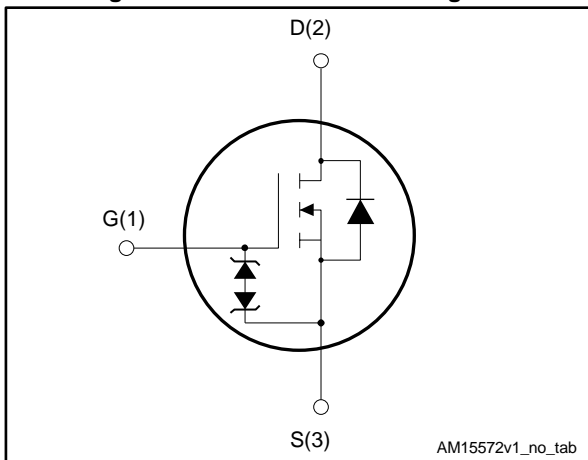

Figure 1: Internal schematic diagram



Features

Order code	V _{DS}	R _{DS(on)} max.	I _D
STFI10LN80K5	800 V	0.63 Ω	8 A

- Fully insulated and low profile package with increased creepage path from pin to heatsink plate
- Industry's R_{DS(on)} x area
- Industry's best FoM (figure of merit)
- Ultra-low gate charge
- 100% avalanche tested
- Zener-protected

Applications

- Switching applications

Description

This very high voltage N-channel Power MOSFET is designed using MDmesh™ K5 technology based on an innovative proprietary vertical structure. The result is a dramatic reduction in on-resistance and ultra-low gate charge for applications requiring superior power density and high efficiency.

Table 1: Device summary

Order code	Marking	Package	Packing
STFI10LN80K5	10LN80K5	I ² PAKFP	Tube

Contents

1	Electrical ratings	3
2	Electrical characteristics	4
	2.1 Electrical characteristics (curves)	6
3	Test circuits	9
4	Package information	10
	4.1 I2PAKFP (TO-281) package information.....	10
5	Revision history	12

1 Electrical ratings

Table 2: Absolute maximum ratings

Symbol	Parameter	Value	Unit
V_{GS}	Gate-source voltage	± 30	V
$I_D^{(1)}$	Drain current (continuous) at $T_C = 25\text{ °C}$	8	A
$I_D^{(1)}$	Drain current (continuous) at $T_C = 100\text{ °C}$	5	A
$I_D^{(2)}$	Drain current pulsed	32	A
P_{TOT}	Total dissipation at $T_C = 25\text{ °C}$	20	W
V_{ISO}	Insulation withstand voltage (RMS) from all three leads to external heat sink ($t=1s$; $T_C=25\text{ °C}$)	2500	V
$dv/dt^{(3)}$	Peak diode recovery voltage slope	4.5	V/ns
$dv/dt^{(4)}$	MOSFET dv/dt ruggedness	50	
T_j	Operating junction temperature range	- 55 to 150	°C
T_{stg}	Storage temperature range		

Notes:

⁽¹⁾Limited by maximum junction temperature.

⁽²⁾Pulse width limited by safe operating area

⁽³⁾ $I_{SD} \leq 8\text{ A}$, $di/dt \leq 100\text{ A}/\mu\text{s}$; $V_{DS\text{ peak}} \leq V_{(BR)DSS}$

⁽⁴⁾ $V_{DS} \leq 640\text{ V}$

Table 3: Thermal data

Symbol	Parameter	Value	Unit
$R_{thj-case}$	Thermal resistance junction-case	6.25	°C/W
$R_{thj-amb}$	Thermal resistance junction-ambient	62.5	°C/W

Table 4: Avalanche characteristics

Symbol	Parameter	Value	Unit
I_{AR}	Avalanche current, repetitive or not repetitive (pulse width limited by T_{jmax})	2.7	A
E_{AS}	Single pulse avalanche energy (starting $T_j = 25\text{ °C}$, $I_D = I_{AR}$, $V_{DD} = 50\text{ V}$)	240	mJ

2 Electrical characteristics

$T_C = 25\text{ °C}$ unless otherwise specified

Table 5: On/off-state

Symbol	Parameter	Test conditions	Min.	Typ.	Max.	Unit
$V_{(BR)DSS}$	Drain-source breakdown voltage	$V_{GS} = 0\text{ V}$, $I_D = 1\text{ mA}$	800			V
I_{DSS}	Zero gate voltage drain current	$V_{GS} = 0\text{ V}$, $V_{DS} = 800\text{ V}$			1	μA
		$V_{GS} = 0\text{ V}$, $V_{DS} = 800\text{ V}$ $T_C = 125\text{ °C}$ ⁽¹⁾			50	μA
I_{GSS}	Gate body leakage current	$V_{DS} = 0\text{ V}$, $V_{GS} = \pm 20\text{ V}$			± 10	μA
$V_{GS(th)}$	Gate threshold voltage	$V_{DS} = V_{GS}$, $I_D = 100\text{ }\mu\text{A}$	3	4	5	V
$R_{DS(on)}$	Static drain-source on-resistance	$V_{GS} = 10\text{ V}$, $I_D = 4\text{ A}$		0.55	0.63	Ω

Notes:

⁽¹⁾Defined by design, not subject to production test.

Table 6: Dynamic

Symbol	Parameter	Test conditions	Min.	Typ.	Max.	Unit
C_{iss}	Input capacitance	$V_{DS} = 100\text{ V}$, $f = 1\text{ MHz}$, $V_{GS} = 0\text{ V}$	-	427	-	pF
C_{oss}	Output capacitance		-	43	-	pF
C_{rss}	Reverse transfer capacitance		-	0.25	-	pF
$C_{o(tr)}$ ⁽¹⁾	Equivalent capacitance time related	$V_{DS} = 0\text{ to }640\text{ V}$, $V_{GS} = 0\text{ V}$	-	72	-	pF
$C_{o(er)}$ ⁽²⁾	Equivalent capacitance energy related			27	-	pF
R_g	Intrinsic gate resistance	$f = 1\text{ MHz}$, $I_D = 0\text{ A}$	-	7	-	Ω
Q_g	Total gate charge	$V_{DD} = 640\text{ V}$, $I_D = 8\text{ A}$ $V_{GS} = 10\text{ V}$ (see Figure 16: "Test circuit for gate charge behavior")	-	15	-	nC
Q_{gs}	Gate-source charge		-	4.2	-	nC
Q_{gd}	Gate-drain charge		-	9	-	nC

Notes:

⁽¹⁾Time related is defined as a constant equivalent capacitance giving the same charging time as C_{oss} when V_{DS} increases from 0 to 80% V_{DSS}

⁽²⁾Energy related is defined as a constant equivalent capacitance giving the same stored energy as C_{oss} when V_{DS} increases from 0 to 80% V_{DSS}

Table 7: Switching times

Symbol	Parameter	Test conditions	Min.	Typ.	Max.	Unit
$t_{d(on)}$	Turn-on delay time	$V_{DD} = 400\text{ V}$, $I_D = 4\text{ A}$, $R_G = 4.7\ \Omega$ $V_{GS} = 10\text{ V}$ (see Figure 15: "Test circuit for resistive load switching times" and Figure 20: "Switching time waveform")	-	11.8	-	ns
t_r	Rise time		-	10	-	ns
$t_{d(off)}$	Turn-off delay time		-	28	-	ns
t_f	Fall time		-	13	-	ns

Table 8: Source-drain diode

Symbol	Parameter	Test conditions	Min.	Typ.	Max.	Unit
I_{SD}	Source-drain current		-		8	A
$I_{SDM}^{(1)}$	Source-drain current (pulsed)		-		32	A
$V_{SD}^{(2)}$	Forward on voltage	$I_{SD} = 8\text{ A}$, $V_{GS} = 0\text{ V}$	-		1.5	V
t_{rr}	Reverse recovery time	$I_{SD} = 8\text{ A}$, $di/dt = 100\text{ A}/\mu\text{s}$, $V_{DD} = 60\text{ V}$ (see Figure 17: "Test circuit for inductive load switching and diode recovery times")	-	350		ns
Q_{rr}	Reverse recovery charge		-	3.9		μC
I_{RRM}	Reverse recovery current		-	22.5		A
t_{rr}	Reverse recovery time	$I_{SD} = 8\text{ A}$, $di/dt = 100\text{ A}/\mu\text{s}$, $V_{DD} = 60\text{ V}$, $T_j = 150\text{ }^\circ\text{C}$ (see Figure 17: "Test circuit for inductive load switching and diode recovery times")	-	505		ns
Q_{rr}	Reverse recovery charge		-	5		μC
I_{RRM}	Reverse recovery current		-	20		A

Notes:⁽¹⁾Pulse width limited by safe operating area⁽²⁾Pulsed: pulse duration = 300 μs , duty cycle 1.5%

Table 9: Gate-source Zener diode

Symbol	Parameter	Test conditions	Min	Typ.	Max	Unit
$V_{(BR)GSO}$	Gate-source breakdown voltage	$I_{GS} = \pm 1\text{ mA}$, $I_D = 0\text{ A}$	30	-	-	V

The built-in back-to-back Zener diodes are specifically designed to enhance the ESD performance of the device. The Zener voltage facilitates efficient and cost-effective device integrity protection, thus eliminating the need for additional external componentry.

2.2 Electrical characteristics (curves)

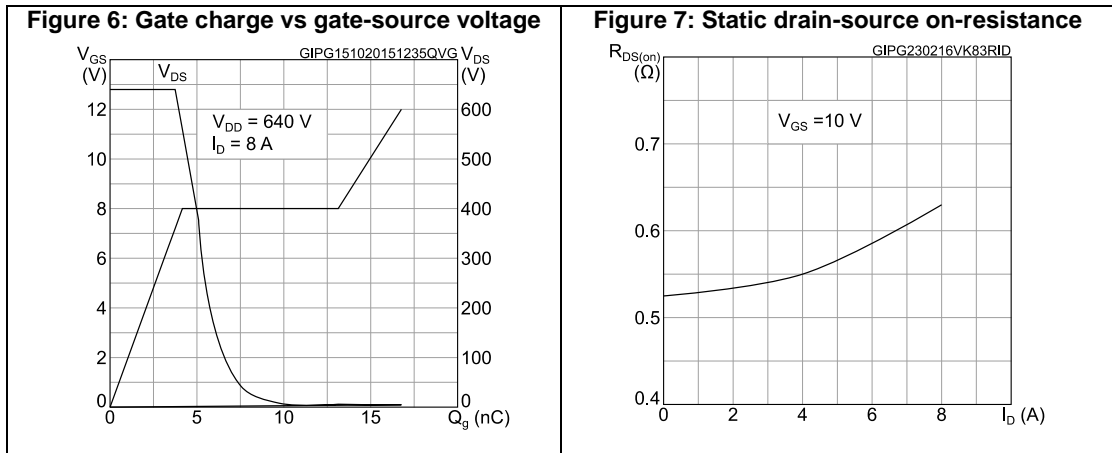
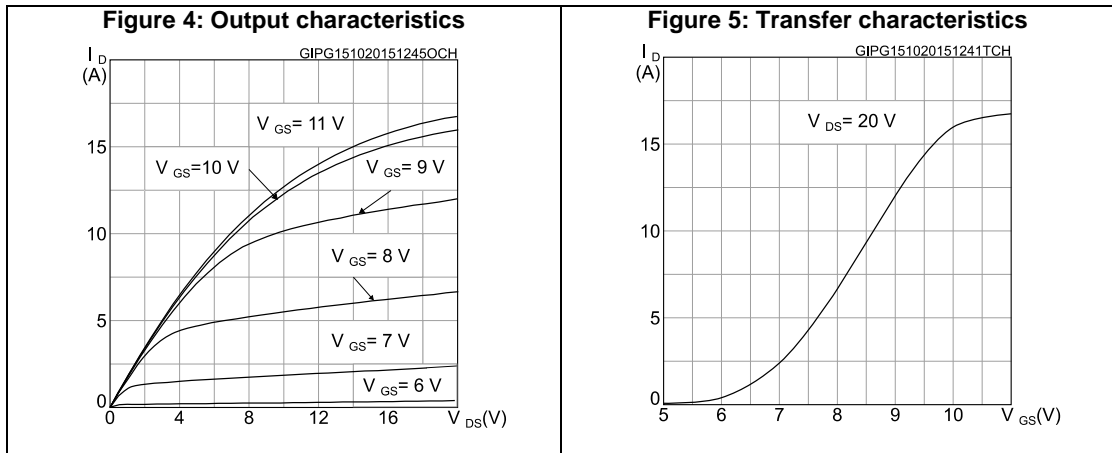
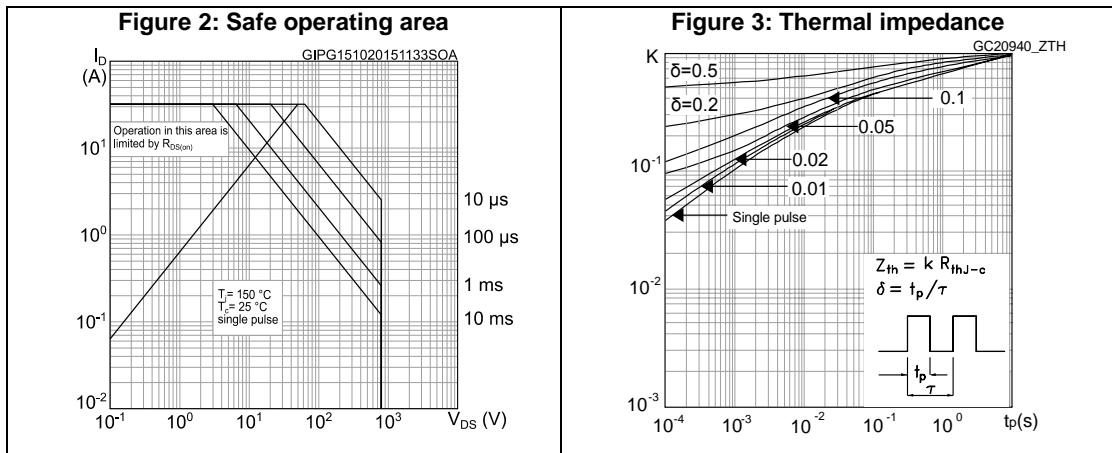

Figure 8: Capacitance variations

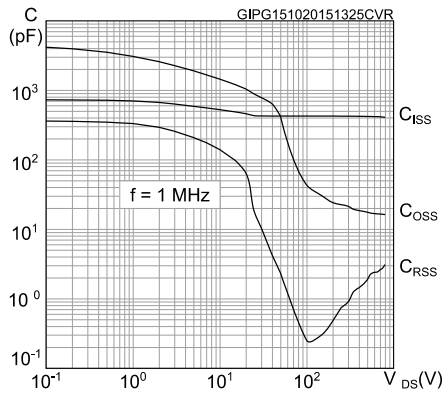

Figure 9: Normalized gate threshold voltage vs temperature

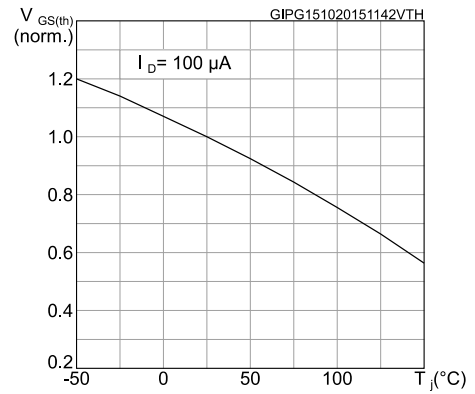

Figure 10: Normalized on-resistance vs temperature

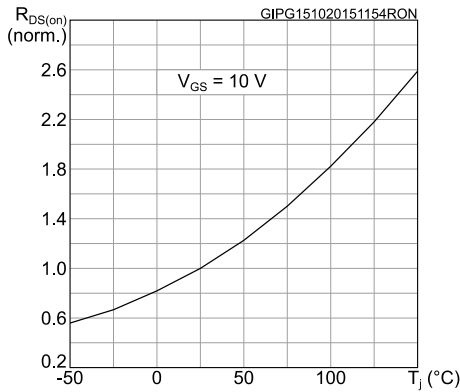

Figure 11: Normalized V_(BR)DSS vs temperature

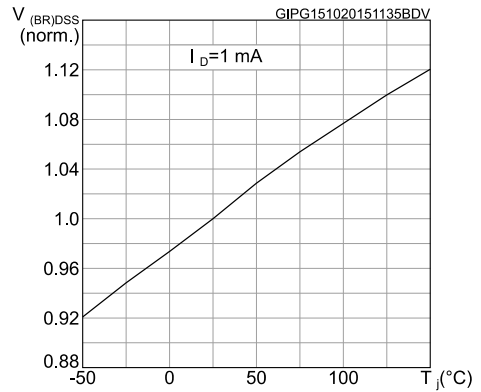

Figure 12: Output capacitance stored energy

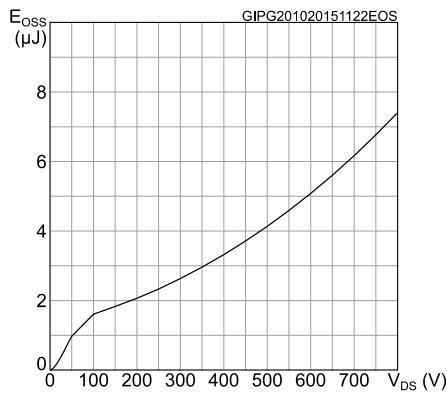

Figure 13: Source-drain diode forward characteristics

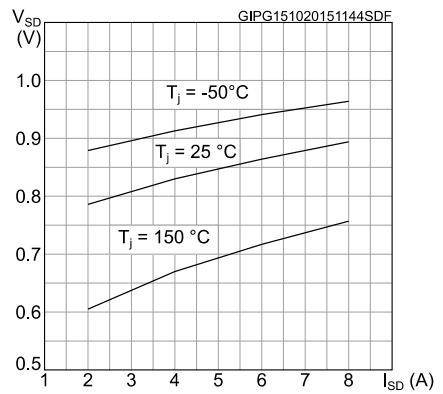
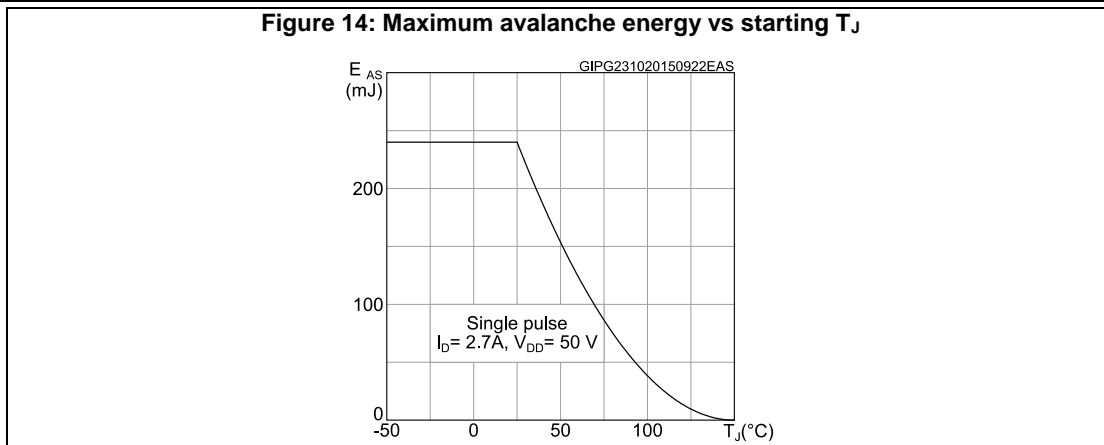
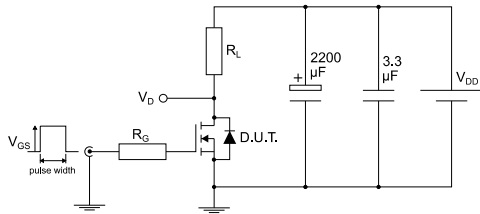

Figure 14: Maximum avalanche energy vs starting T_J



3 Test circuits

Figure 15: Test circuit for resistive load switching times



AM01468v1

Figure 16: Test circuit for gate charge behavior

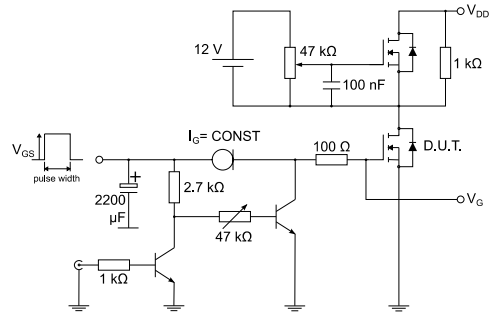

AM01469v1

Figure 17: Test circuit for inductive load switching and diode recovery times

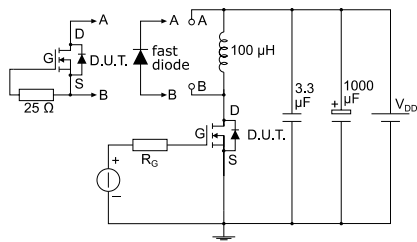

AM01470v1

Figure 18: Unclamped inductive load test circuit

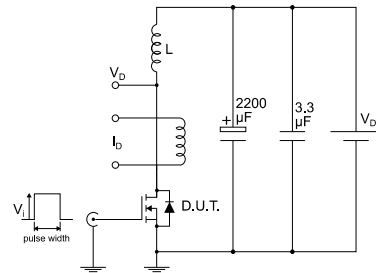

AM01471v1

Figure 19: Unclamped inductive waveform

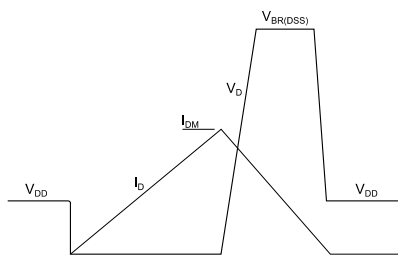

AM01472v1

Figure 20: Switching time waveform

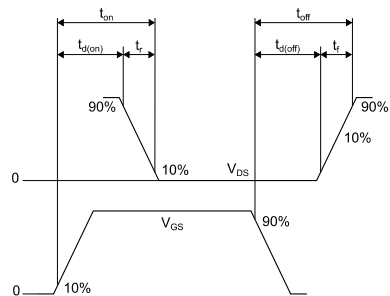

AM01473v1

4 Package information

In order to meet environmental requirements, ST offers these devices in different grades of ECOPACK® packages, depending on their level of environmental compliance. ECOPACK® specifications, grade definitions and product status are available at: www.st.com. ECOPACK® is an ST trademark.

4.1 I²PAKFP (TO-281) package information

Figure 21: I²PAKFP (TO-281) package outline

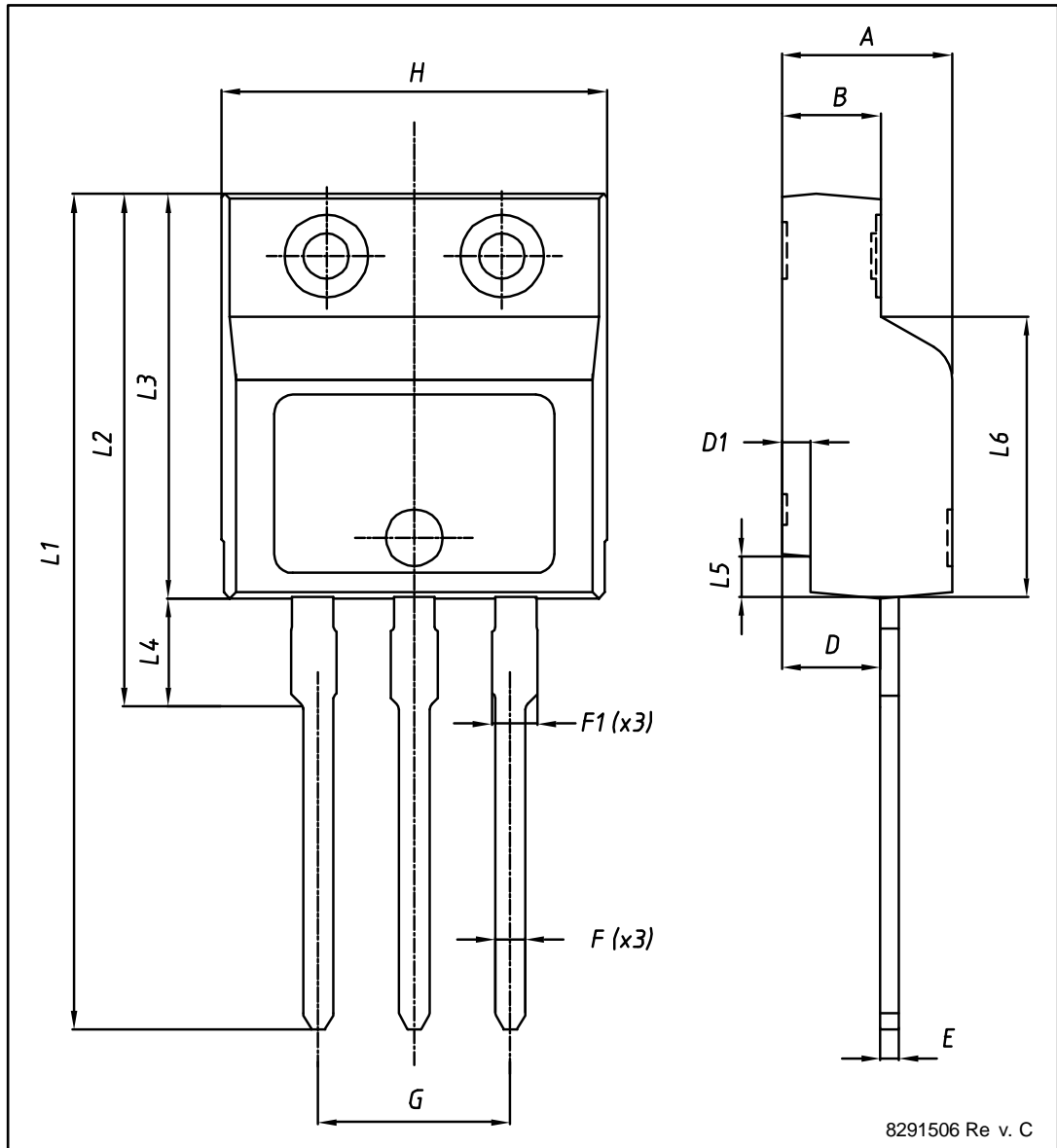

8291506 Re v. C

Table 10: I²PAKFP (TO-281) mechanical data

Dim.	mm		
	Min.	Typ.	Max.
A	4.40		4.60
B	2.50		2.70
D	2.50		2.75
D1	0.65		0.85
E	0.45		0.70
F	0.75		1.00
F1			1.20
G	4.95		5.20
H	10.00		10.40
L1	21.00		23.00
L2	13.20		14.10
L3	10.55		10.85
L4	2.70		3.20
L5	0.85		1.25
L6	7.50	7.60	7.70

5 Revision history

Table 11: Document revision history

Date	Revision	Changes
10-Feb-2016	1	First release.

IMPORTANT NOTICE – PLEASE READ CAREFULLY

STMicroelectronics NV and its subsidiaries ("ST") reserve the right to make changes, corrections, enhancements, modifications, and improvements to ST products and/or to this document at any time without notice. Purchasers should obtain the latest relevant information on ST products before placing orders. ST products are sold pursuant to ST's terms and conditions of sale in place at the time of order acknowledgement.

Purchasers are solely responsible for the choice, selection, and use of ST products and ST assumes no liability for application assistance or the design of Purchasers' products.

No license, express or implied, to any intellectual property right is granted by ST herein.

Resale of ST products with provisions different from the information set forth herein shall void any warranty granted by ST for such product.

ST and the ST logo are trademarks of ST. All other product or service names are the property of their respective owners.

Information in this document supersedes and replaces information previously supplied in any prior versions of this document.

© 2016 STMicroelectronics – All rights reserved