



SPECIFICATION SHEET

SPECIFICATION SHEET NO.	N0729-SOT893L0D882GR
DATE	July 29, 2021
REVISION	A0
DESCRIPTION	SMD Plastic-Encapsulate Transistors, SOT-89-3L series, 3 pads D882-GR Type, Complementary NPN Collector Power Dissipation 500mW. Collector Current 3A Max. Operating Temp. Range -55°C ~+150°C, Package in Tape/Reel, 1000pcs/Reel RoHS/RoHS III compliant
CUSTOMER	
CUSTOMER PART NUMBER	
CROSS REF. PART NUMBER	
ORIGINAL PART NUMBER	MDD D882- GR
PART CODE	SOT893L0D882GR

VENDOR APPROVE			
Issued/Checked/Approved			
DATE: July 29, 2021			

CUSTOMER APPROVE	
DATE:	

SMD PLASTIC-ENCAPULATE TRANSISTORS SOT-89-3L SERIES

MAIN FEATURE

- Epitaxial planar die construction
- Complementary NPN
- Collector Power Dissipation 500mW
- Collector Current 3A.



APPLICATION

- For printed circuit board

RFQ

[Request For Quotation](#)

PART CODE GUIDE

SOT893L	0	D882	GR
1	2	3	4

- 1) **SOT893L**: SMD Plastic-Encapsulate Transistors, 3 pads SOT-89-3L series Code
- 2) **0**: Internal control code, 1 digits or letter
- 3) **D882**: Type Code for original part number D882
- 4) **GR**: Classification and rank code for DC current Gain Max. range 200~400

SMD PLASTIC-ENCAPULATE TRANSISTORS SOT-89-3L SERIES

DIMENSION (Unit: Inch/mm)

Image for reference



Marking: D882

SOT-89-3L

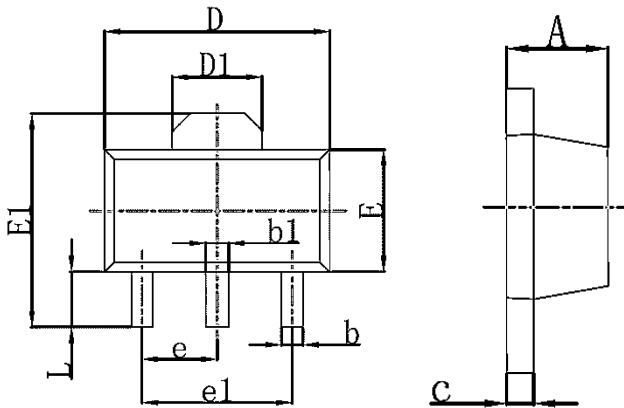

Symbol	Value (mm)		
	Min.	Typ.	Max.
A	1.4		1.6
b	0.32		0.52
b1	0.40		0.58
c	0.35		0.44
D	4.4		4.6
E	2.3		2.60
E1	3.94		4.25
e		1.5	
e1		3.0	
L	0.90		1.20

Recommend Pad Layout
(unit: mm +/-0.05)

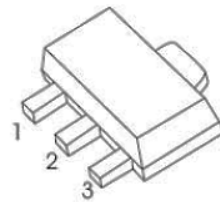
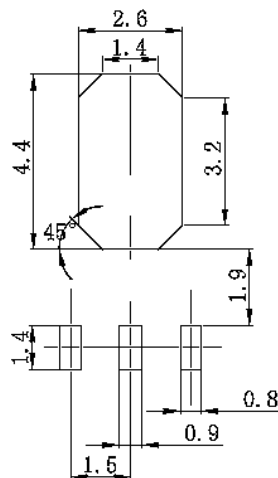

Pin 1: Base
Pin 2: Collect
Pin 3: Emitter

SMD PLASTIC-ENCAPULATE TRANSISTORS SOT-89-3L SERIES
MECHANICAL DATA

Case	Terminals	Polarity	Mounting Position	Weight per piece
JEDEC SOT-89-3L molded plastic body	Solder plated, Solderable per MIL-STD-750, Method 2026	Polarity symbol marking on case	Any	n/a

MAX. RATINGS AT Ta=25 °C

Parameter	SYMBOLS	VALUE	UNITS
		LIMIT	
Collector-Base Voltage	V _{CBO}	40	Volts
Collector-Emitter Voltage	V _{CEO}	30	Volts
Emitter-Base Voltage	V _{EBO}	6	Volts
Collector Current	I _C	300	mA
Collector Power Dissipation	P _C	500	mW
Thermal Resistance Junction to Ambient	R _{QJA}	250	°C/W
Junction temperature	T _J	+150	°C
Storage temperature range	T _{STG}	-55 ~ +150	°C

SMD PLASTIC-ENCAPULATE TRANSISTORS SOT-89-3L SERIES
ELECTRICAL CHARACTERISTICS AT Ta= 25 °C

Parameter	SYMBOLS	VALUE			UNIT	Condition
		Min.	Typ.	Max.		
Collector-base breakdown voltage	V(BR)CBO	40			V	Ic= 100μA, IE=0
Collector-emitter breakdown voltage	V(BR)CEO	30			V	Ic= 1mA, IB=0
Emitter-base breakdown voltage	V(BR)EBO	6			V	IE=100μA, IC=0
Collector cut-off current	I CBO			1	μA	VCB=40V, IE=0
Collector cut-off current	I CEO			10	μA	VCE=30V, IB =0
Emitter cut-off current	I EBO			1	μA	VEB= 6V, IC=0
DC Current gain	h FE(1)	30	150			VCE=2V, IC= 0.2A
	h FE(2)	60	160	400		VCE=2V, IC= 1A
Collector-emitter saturation voltage	V CE(sat)		0.3	0.5	V	IC=2A, IB= 0.2A
Base-emitter saturation voltage	V BE(sat)		1	2	V	IC=2A, IB= 0.2A
Transition frequency	f T		90		MHz	VCE=5V, IC= 0.1A, f=10MHz
Collector Output Capacitance	C ob		45		pF	VCB=10V, IC= 0 f=1MHz

CLASSIFICATION OF hFE

Rank	R	O	Y	GR
Range	60 ~ 120	100~200	160~320	200 ~ 400

SMD PLASTIC-ENCCAPULATE TRANSISTORS SOT-89-3L SERIES
RELIABILITY

Number	Experiment Items	Experiment Method And Conditions	Reference Documents
1	Solder Resistance Test	Test 260°C± 5°C for 10 ± 2 sec. Immerse body into solder 1/16" ± 1/32"	MIL-STD-750D METHOD-2031.2
2	Solderability Test	230°C ±5°C for 5 sec.	MIL-STD-750D METHOD-2026.1 0
3	Pull Test	1 kg in axial lead direction for 10 sec.	MIL-STD-750D METHOD-2036.4
4	Bend Test	0.5Kg Weight Applied To Each Lead, Bending Arcs 90 °C ± 5 °C For 3 Times	MIL-STD-750D METHOD-2036.4
5	High Temperature Reverse Bias Test	TA=100°C for 1000 Hours at VR=80% Rated VR	MIL-STD-750D METHOD-1038.4
6	Forward Operation Life Test	TA=25°C Rated Average Rectified Current	MIL-STD-750D METHOD-1027.3
7	Intermittent Operation Life Test	On state: 5 min with rated IRMS Power Off state: 5 min with Cool Forced Air. On and off for 1000 cycles.	MIL-STD-750D METHOD-1036.3
8	Pressure Cooker Test	15 PSIG, TA=121°C, 4 hours	MIL-S-19500 APPENOIXC
9	Temperature Cycling Test	-55°C~+125°C; 30 Minutes For Dwelled Time 5 minutes for transferred time. Total: 10 cycles.	MIL-STD-750D METHOD-1051.7
10	Thermal Shock Test	0°C for 5 minutes., 100°C for 5minutes, Total: 10 cycles	MIL-STD-750D METHOD-1056.7
11	Forward Surge Test	8.3ms Single Sale Sine-wave One Surge.	MIL-STD-750D METHOD-4066.4
12	Humidity Test	TA=65°C, RH=98% for 1000 hours.	MIL-STD-750D METHOD-1021.3
13	High Temperature Storage life Test	150°C for 1000 Hours	MIL-STD-750D METHOD-1031.5

SMD PLASTIC-ENCCAPULATE TRANSISTORS SOT-89-3L SERIES

SUGGESTED REFLOW PROFILE (For Reference Only)

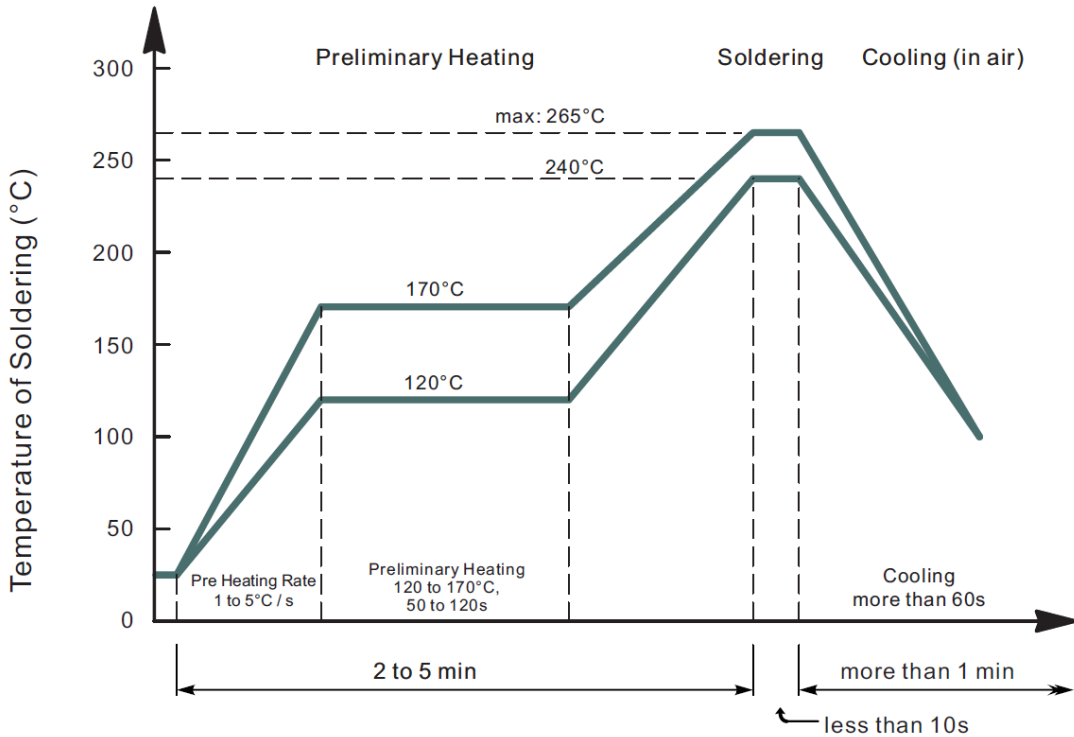

- Recommended peak temperature is over 245°C, If peak temperature is below 245 °C, you may adjust the following parameters; time length of peak temperature (longer), time length of soldering (longer), thickness of solder paste (thicker)
- Welding shall not exceed 2 times
- Remark: lead free solder paste (96.5 sn/3.0 Ag/0.5Cu)

SMD PLASTIC-ENCCAPULATE TRANSISTORS SOT-89-3L SERIES

RATINGS AND CHARACTERISTIC CURVES (For Reference Only)

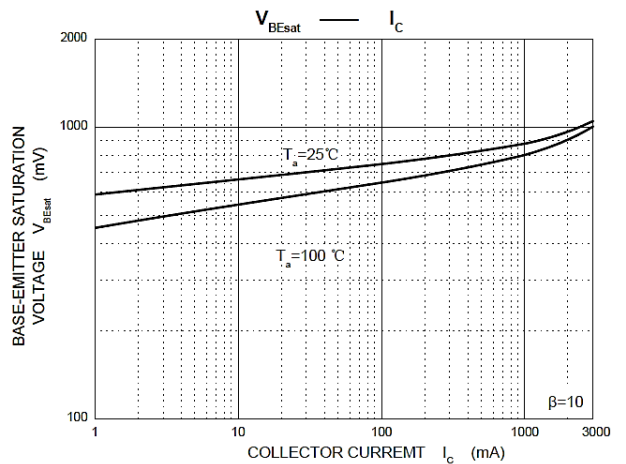
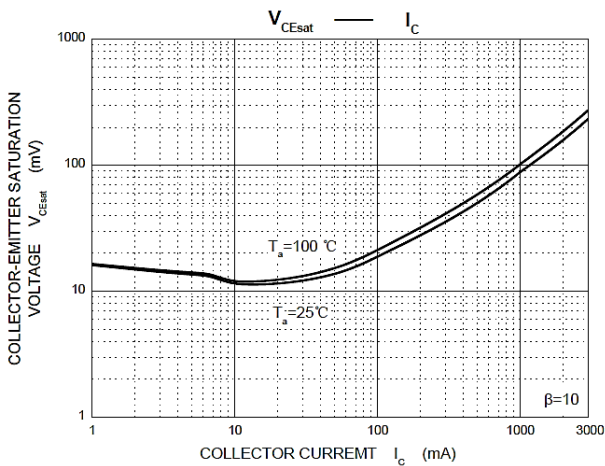
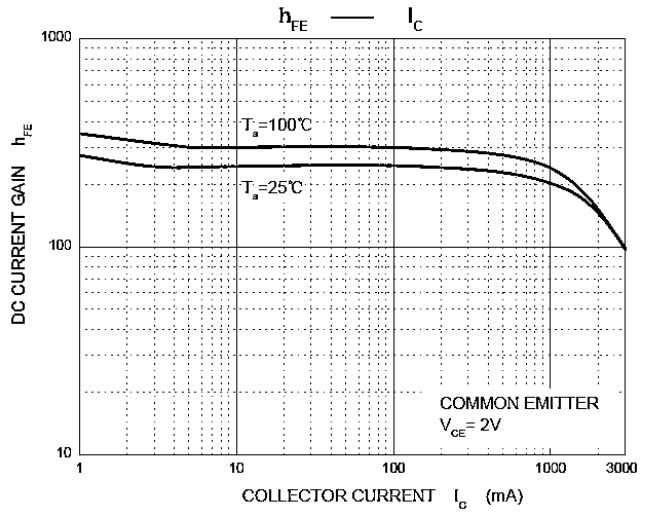
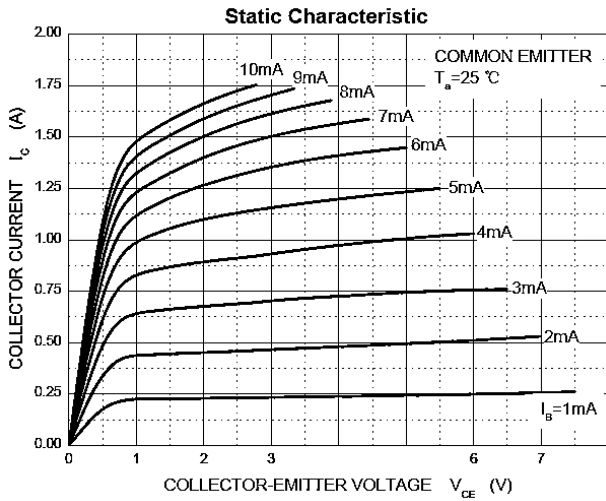

SMD PLASTIC-ENCAPULATE TRANSISTORS SOT-89-3L SERIES

RATINGS AND CHARACTERISTIC CURVES (For Reference Only)

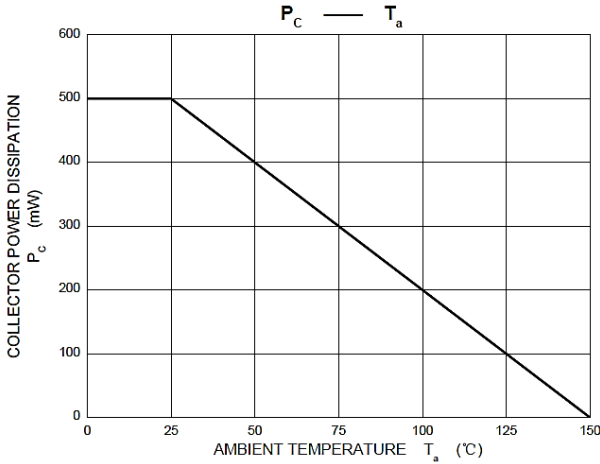
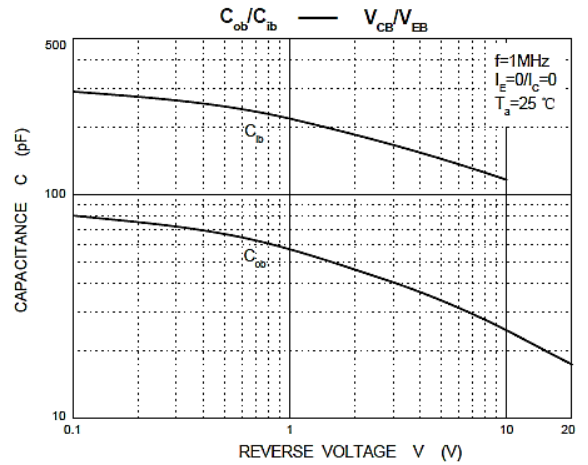
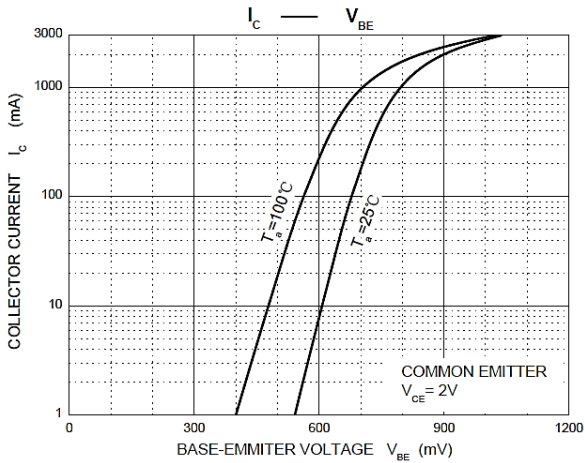

SMD PLASTIC-ENCCAPULATE TRANSISTORS SOT-89-3L SERIES

TAPE/REEL (Unit: mm)

All Devices are packed in accordance with EIA standard RS-481-A and specifications.

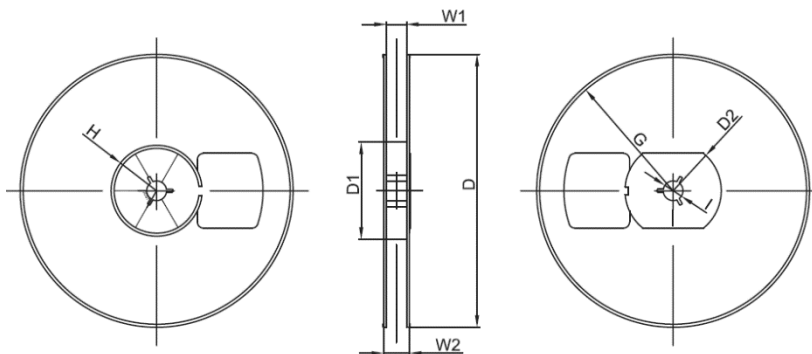
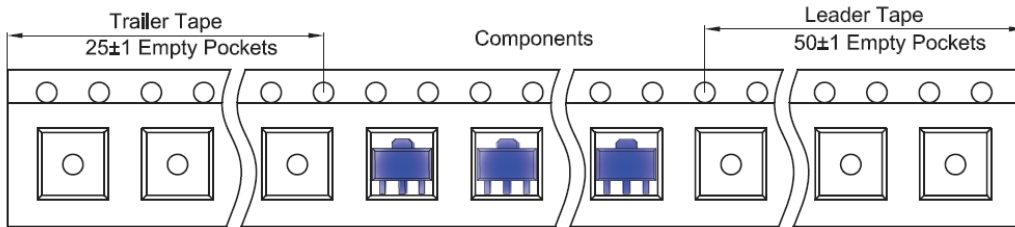
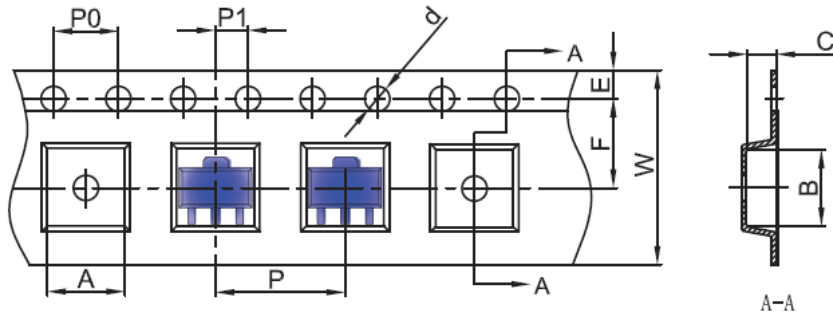

Symbol	Dimension (mm)
A	4.85
B	4.45
C	1.85
d	φ1.50
E	1.75
F	5.50
P 0	4.00
P	8.00
P 1	2.00
W	12.00
D	φ180
D1	60.0
D2	R32.0
G	R86.50
H	R30.00
I	φ13.0
W 1	13.20
W2	16.50

SMD PLASTIC-ENCAPULATE TRANSISTORS SOT-89-3L SERIES

PACKAGE

Case Code	Reel Size	MPQ (pcs)	Component Spacing (mm)	Qty. Per Box (pcs)	Inner Box L*W*H (mm)	Reel Size (mm)	Carton size L*W*H (mm)	Qty. Per Carton (pcs)	G. W (kg)
SOT-89-3L	7"	1,000		15,000	203*203*195	178	438*438*220	40,000	7.0

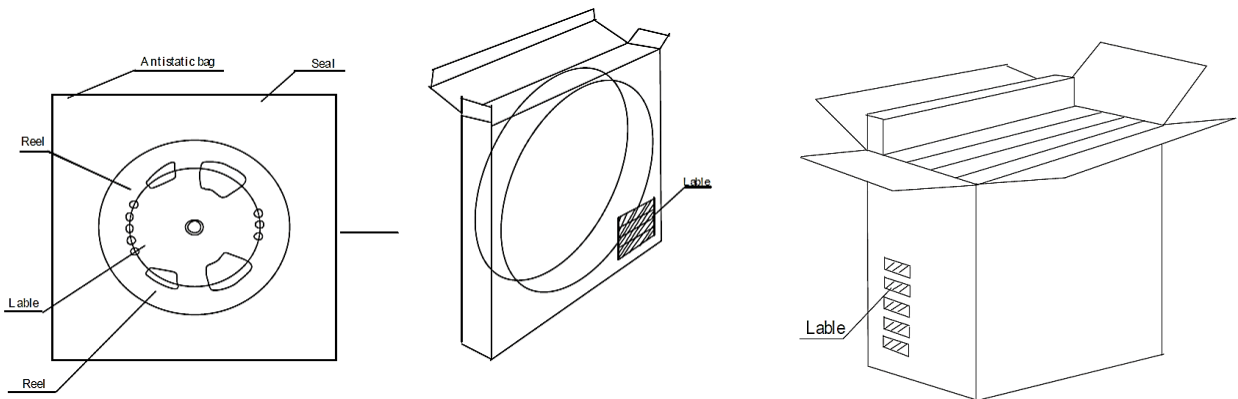

DISCLAIMER

NextGen Component, Inc. reserves the right to make changes to the product(s) and or information contained herein without notice. No liability is assumed as a result of their use or application. No rights under any patent accompany the sale of any such product(s) or information