



LEARN HOW TO LIGHT UP A TEXTILES PROJECT

LED FLASHER MODULE KIT



INTRODUCTION TO ELECTRO-FASHION



Electro-Fashion is Kitronik's own range of E-Textiles parts. With this range, makers can easily introduce LEDs to Textiles projects. The system works by using conductive thread, which sews like normal thread but conducts electricity like wire. To light an LED, the conductive thread must be firmly attached to the LED, sewn through the fabric, and connected to a battery. Switches may also be introduced to the E-Textile circuit: LED(s) can be activated by the push of a button, a slide of a switch, a magnetic connection, a gentle tilt, or, even, as darkness is detected. We have developed a wide range of switches and LEDs so that makers have enough scope to explore and enjoy the possibilities of E-Textiles.

TUTORIALS

In addition to supplying the fundamental parts of any E-Textile project, we also offer a selection of online E-Textiles tutorials and resources with step-by-step guidance and cutting pattern templates. These resources cover how to introduce different LEDs and switches to E-Textiles circuits. Please visit our website for more details at www.kitronik.co.uk/fashionresources

ELECTRO-FASHION CONDUCTIVE THREAD

This is Kitronik's very own Electro-Fashion branded conductive thread and we think it is among the best conductive thread available. It is perfect for hand sewing and can be used on the bottom bobbin of a sewing machine (this will require the thread to be wound on to the smaller bottom bobbin first).



USING THIS BOOKLET

Use the simple guide below to select the sections of the booklet relevant to the kit you are using.

1 INTRODUCING SEWABLE COMPONENTS

2A STANDARD KIT FEATURES

2B CONDUCTIVE THREAD FLASHER UNIT

3 FAULT FINDING

1 INTRODUCING SEWABLE COMPONENTS

STITCHED CONNECTIONS

It is important to create tight and secure connections at the point where the thread attaches to the battery holder and LEDs. The thread must be attached tightly to these items, so that a good electrical connection is established. Each joint should be stitched through a number of times, each time it should be pulled tight, to ensure this is the case.



SEWABLE LEDs

In designs where a standard LED is too bulky, sewable LED boards can be used. These are very thin at just a few mm high and also have the advantage of connections that are labelled with a '+' and '-'.

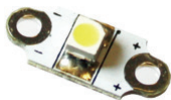

USING LEDs WITH LEGS

The LEDs that are used in the kit will only work if they are connected the correct way around. It is very easy to determine the positive leg (anode) and negative leg (cathode).

LEG LENGTH

The easiest way to identify the positive and negative leg is by the length of the legs. The long leg is the positive '+' and the short leg is the negative '-'.



FLAT EDGE

The other way of identifying the negative '-' leg is by the flat edge on the LED. This can be very useful if you have formed your leg into eyelets.



FORMING THE LED LEGS INTO 'EYELETS'

To make the LEDs easier to stitch into position the legs can be formed into 'eyelets'. This can be achieved easily by forming the legs of the LED with a pair of long nose pliers. The reason for creating the 'eyelets' is to ensure the thread can be securely attached the LED, without the possibility of it being easily dislodged.

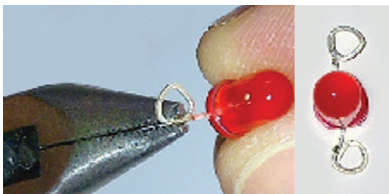

CHECKING LED COLOUR

You can check the colour of an LED by placing a coin cell battery between the legs of the LED as shown in the picture. It is important to connect the battery the correct way around otherwise it will not work. The longest leg of the LED should touch the side of the battery marked with the '+' sign.

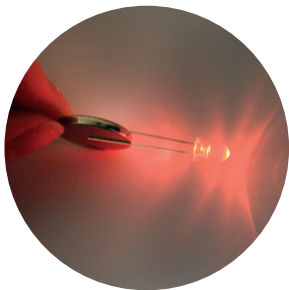

CONNECTING THE LEDS

A basic sewable LED circuit is very simple and created by placing the LEDs in parallel with the battery. This is shown in the circuit diagram below.

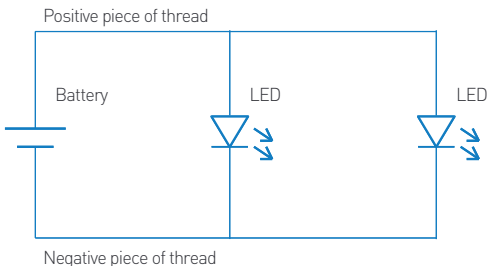

CIRCUIT DIAGRAM

To recreate this circuit, two pieces of conductive thread are used. One is used to connect the positive connection on the battery holder, to the positive leg on each LED used. The second piece of thread is used to connect the negative connection on the battery holder, to the negative leg on each LED used. The positive and negative pieces of thread must not touch each other.

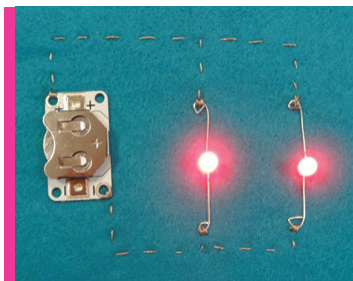

STITCHED EQUIVALENT

ADDING A PRESS STUD SWITCH

This is an easy way to add a textiles 'switch' into your circuit. Instead of the positive thread being sewn directly to the LED, a metal press stud is sewn in series as shown below.

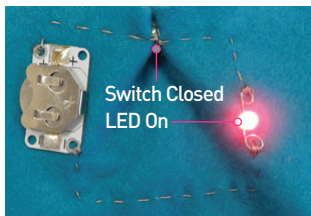
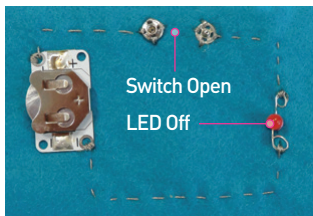

OTHER SWITCHES

Other types of switches can be used to turn the LEDs on or off. These are connected in exactly the same way as the press stud example above. With the push button switch the LEDs are on when the button is pressed, the slide switch works the same way as a light switch. The tilt switch turns the LEDs on when tipped up and with the magnetic switch the LEDs are on when the magnet is close to the switch.



PUSH SWITCH



SLIDE SWITCH



TILT SWITCH



MAGNETIC SWITCH
AND MAGNET

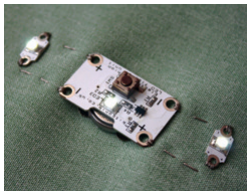

This unit offers a simple way of adding Flashing LEDs to a textiles project. It is programmed with flashing patterns that are selected by a push button.

LED PATTERNS

Pressing the button on the front of the control PCB causes the LEDs to cycle through the four available patterns. These patterns and the sequence in which they are activated are shown to the right.

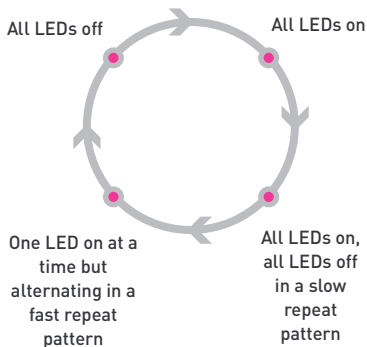

AUTO-OFF FUNCTION

To ensure that the batteries are not flattened by an accidental triggering of the product (i.e. if it is carried in a bag and the button gets pressed) it has a built auto turn off function. This turns all the LEDs off if the LEDs are left in any of the other modes for around 30 minutes without the button being pressed. When the button is pressed to change the mode this 30 minute time out is reset and starts again.

BATTERY LIFE

Battery life when the LEDs are in use is about 2 days. When the board is in the 'all LEDs off' state it uses virtually no power. As such the batteries will not lose any noticeable charge and will not go flat.

CONNECTING THE BOARDS

The three boards should be connected together using the conductive thread as shown below. You will need to make sure that they are connected in the correct polarity. This is shown by the '+' and '-' marks on the top of the PCBs. The positive pads on the main PCB connect to the positive pads on the LED PCBs. The negative connections are made in the same way.

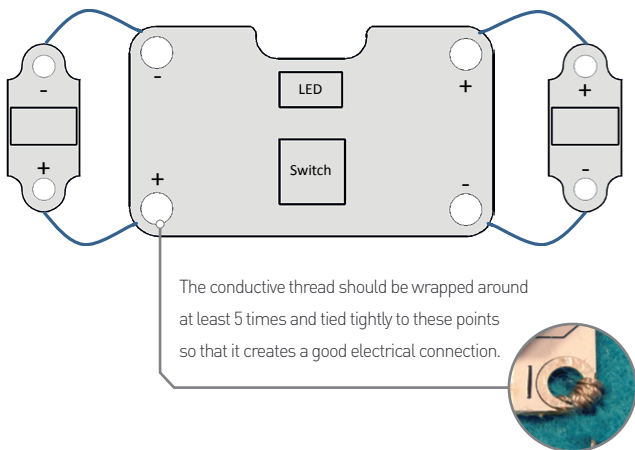

3 FAULT FINDING

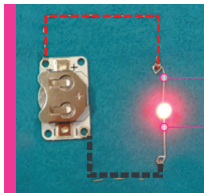

LED ORIENTATION

- ✓ Must be the long leg of the LED.
- ✓ Must be the flat edge of the LED.

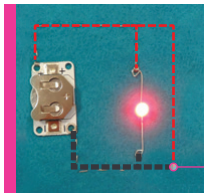

SHORT CIRCUIT

- ✗ Do not allow the positive and negative pieces of thread to touch.

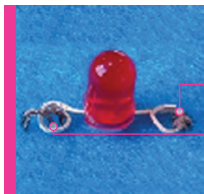

LOOSE CONNECTIONS

- ✓ Good tight connection
- ✗ Poor loose connection

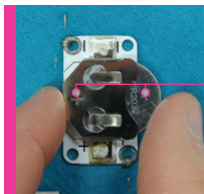

BATTERY INSERTION

- ✓ Positive identifiers match

OTHER PARTS IN THE ELECTRO-FASHION RANGE



STANDARD COIN
CELL HOLDER



MINIATURE COIN
CELL HOLDER

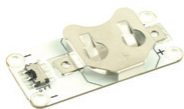

SWITCHED COIN CELL HOLDER

The coin cell holder has a small power switch so that you can turn the power on and off.

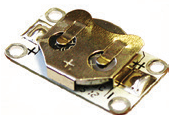

FLASHER UNIT

This unit offers a simple way of adding 'flashing' white LEDs to a textiles project.



LIGHT SENSOR

This board senses light and will turn the LEDs on automatically in the dark.

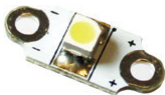

SEWABLE LEDs

Blue LEDs	●
White LEDs	○
Green LEDs	●
Red LEDs	●
Sakuru LEDs	●



This unit provides a simple way of adding flashing white LEDs to a textiles project using conductive thread, such as the ladybird example (shown on front). The unit is programmed with a number of flashing patterns, which are selected by a push button on the main PCB. The device features auto off, which turns the unit off after 30 minutes to preserve battery life.



Contains enough parts to build 1 project



KIT INCLUDES:

- 1 x Main Flasher Controller Board
- 2 x Sewable White LEDs
- 1 x Battery
- 1 x 2m Conductive Thread



INSTRUCTIONS:

This booklet contains assembly instructions. More detailed step by step guides are available on the website.



TOOLS REQUIRED:

- Scissors
- Needle



STOCK CODE

2719

WELCOME TO SEWABLE ELECTRONICS



T: 0845 8380781

W: www.kitronik.co.uk

E: support@kitronik.co.uk



[kitronik.co.uk/twitter](https://twitter.com/kitronik)





[kitronik.co.uk/facebook](https://facebook.com/kitronik)



[kitronik.co.uk/youtube](https://youtube.com/kitronik)



[kitronik.co.uk/google](https://google.com/kitronik)

 Designed & manufactured in the UK by 



Children assembling this product should be supervised by a competent adult. The product contains small parts so should be kept out of reach of children under 3 years old.