

N-Channel Enhancement Mode Power MOSFET

Description

The 03N06 uses advanced trench technology to provide excellent $R_{DS(ON)}$, low gate charge. It can be used in a wide variety of applications.

General Features

- V_{DS} 60V
- I_D (at $V_{GS} = 10V$) 3A
- $R_{DS(ON)}$ (at $V_{GS} = 10V$) < 80mΩ
- $R_{DS(ON)}$ (at $V_{GS} = 4.5V$) < 90mΩ
- 100% Avalanche Tested
- RoHS Compliant

Application

- Power switch
- DC/DC converters

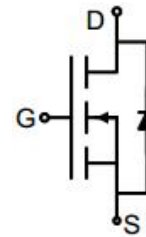

Schematic diagram

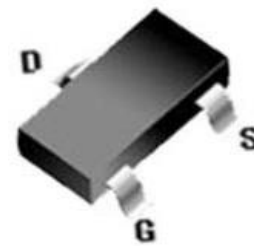

SOT-23

Ordering Information

Device	Package	Marking	Packaging
03N06	SOT-23	03N06	3000pcs/Reel

Absolute Maximum Ratings $T_C = 25^\circ C$, unless otherwise noted

Parameter	Symbol	Value	Unit
Drain-Source Voltage	V_{DS}	60	V
Continuous Drain Current	I_D	3	A
Pulsed Drain Current (note1)	I_{DM}	12	A
Gate-Source Voltage	V_{GS}	± 20	V
Power Dissipation	P_D	1.7	W
Operating Junction and Storage Temperature Range	T_J, T_{stg}	-55 To 150	$^\circ C$

Thermal Resistance

Parameter	Symbol	Value	Unit
Maximum Junction-to-Case	R_{thJC}	73.5	$^\circ C/W$

Specifications $T_J = 25^\circ\text{C}$, unless otherwise noted						
Parameter	Symbol	Test Conditions	Value			Unit
			Min.	Typ.	Max.	
Static Parameters						
Drain-Source Breakdown Voltage	$V_{(BR)DSS}$	$V_{GS} = 0V, I_D = 250\mu A$	60	--	--	V
Zero Gate Voltage Drain Current	I_{DSS}	$V_{DS} = 60V, V_{GS} = 0V$	--	--	1	μA
Gate-Source Leakage	I_{GSS}	$V_{GS} = \pm 20V$	--	--	± 100	nA
Gate-Source Threshold Voltage	$V_{GS(th)}$	$V_{DS} = V_{GS}, I_D = 250\mu A$	0.7	1.0	1.2	V
Drain-Source On-Resistance	$R_{DS(on)}$	$V_{GS} = 10V, I_D = 2A$	--	65	80	m Ω
		$V_{GS} = 4.5V, I_D = 1A$	--	70	90	
Forward Transconductance	g_{FS}	$V_{GS} = 5V, I_D = 2A$	--	9	--	S
Dynamic Parameters						
Input Capacitance	C_{iss}	$V_{GS} = 0V,$ $V_{DS} = 30V,$ $f = 1.0\text{MHz}$	--	458	--	pF
Output Capacitance	C_{oss}		--	24	--	
Reverse Transfer Capacitance	C_{rss}		--	21	--	
Total Gate Charge	Q_g	$V_{DD} = 30V,$ $I_D = 2A,$ $V_{GS} = 10V$	--	14.6	--	nC
Gate-Source Charge	Q_{gs}		--	1.6	--	
Gate-Drain Charge	Q_{gd}		--	3	--	
Turn-on Delay Time	$t_{d(on)}$	$V_{DD} = 30V,$ $I_D = 2A,$ $R_G = 1\Omega$	--	6	--	ns
Turn-on Rise Time	t_r		--	15	--	
Turn-off Delay Time	$t_{d(off)}$		--	15	--	
Turn-off Fall Time	t_f		--	10	--	
Drain-Source Body Diode Characteristics						
Continuous Body Diode Current	I_S	$T_C = 25^\circ\text{C}$	--	--	3	A
Body Diode Voltage	V_{SD}	$T_J = 25^\circ\text{C}, I_{SD} = 2A, V_{GS} = 0V$	--	--	1.2	V
Reverse Recovery Charge	Q_{rr}	$I_F = 2A, V_{GS} = 0V$ $di/dt = 100A/\mu s$	--	38	--	nC
Reverse Recovery Time	T_{rr}		--	36	--	ns

Notes

1. Repetitive Rating: Pulse width limited by maximum junction temperature
2. Identical low side and high side switch with identical R_G

Gate Charge Test Circuit



Switch Time Test Circuit



EAS Test Circuit

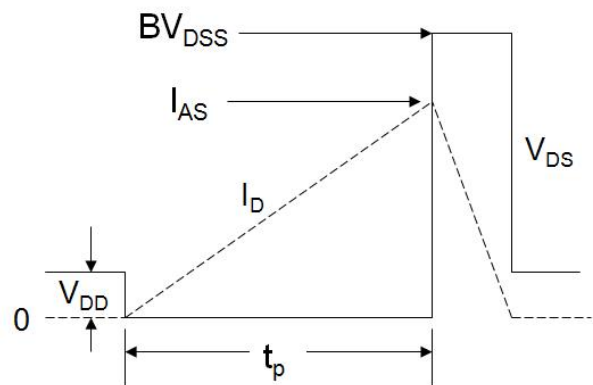

Typical Characteristics $T_J = 25^\circ\text{C}$, unless otherwise noted

Figure 1. Output Characteristics

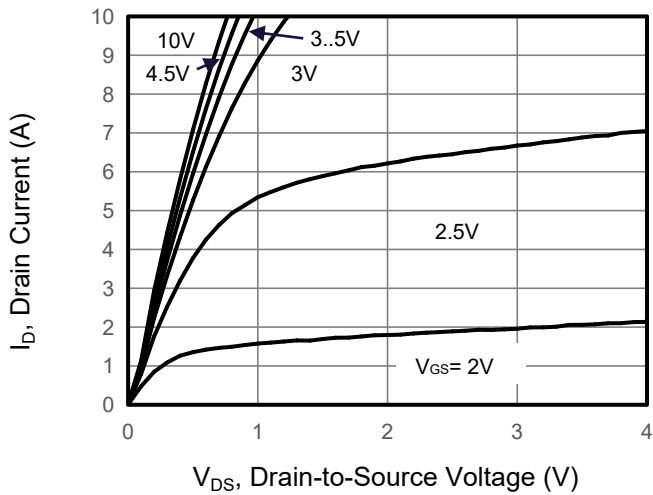

Figure 2. Transfer Characteristics

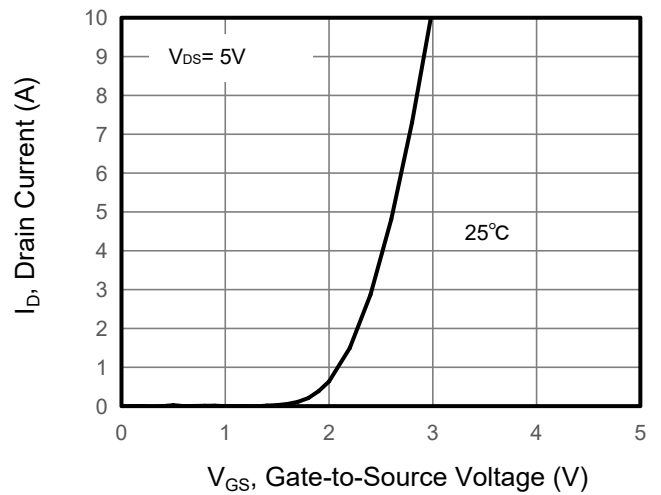

Figure 3. Drain Source On Resistance

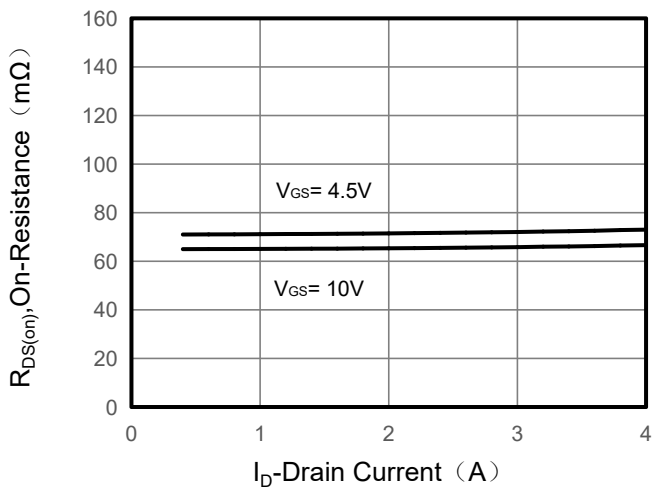

Figure 4. Gate Charge

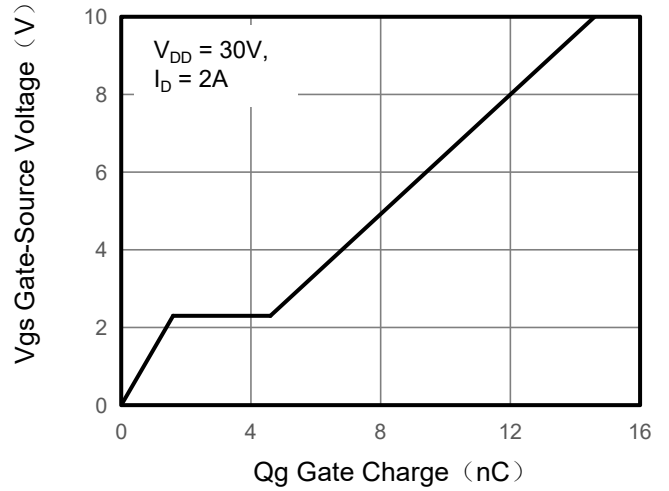

Figure 5. Capacitance

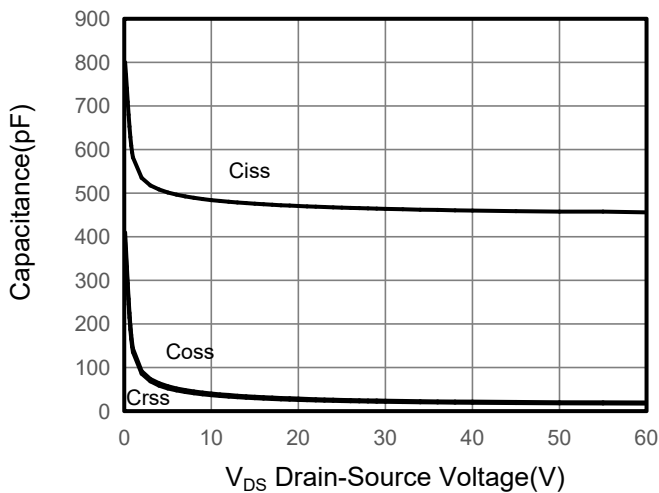
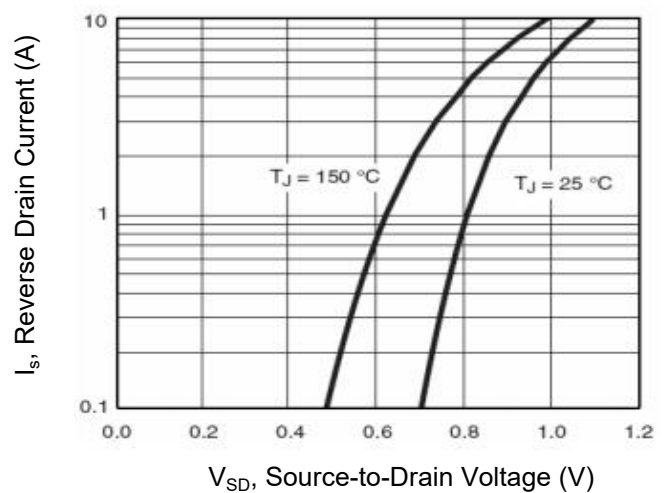

Figure 6. Source-Drain Diode Forward



Typical Characteristics $T_J = 25^\circ\text{C}$, unless otherwise noted

Figure 7. Drain-Source On-Resistance

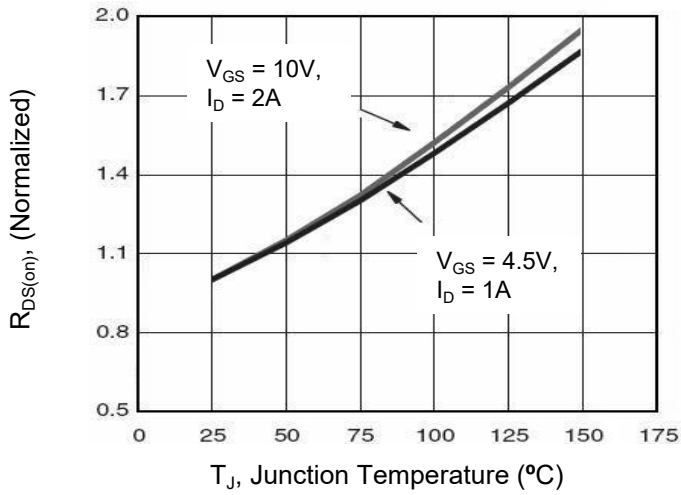

Figure 8. Safe Operation Area

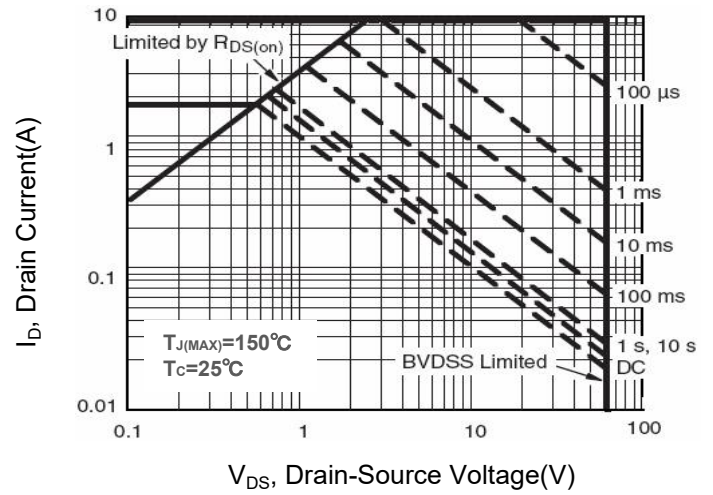
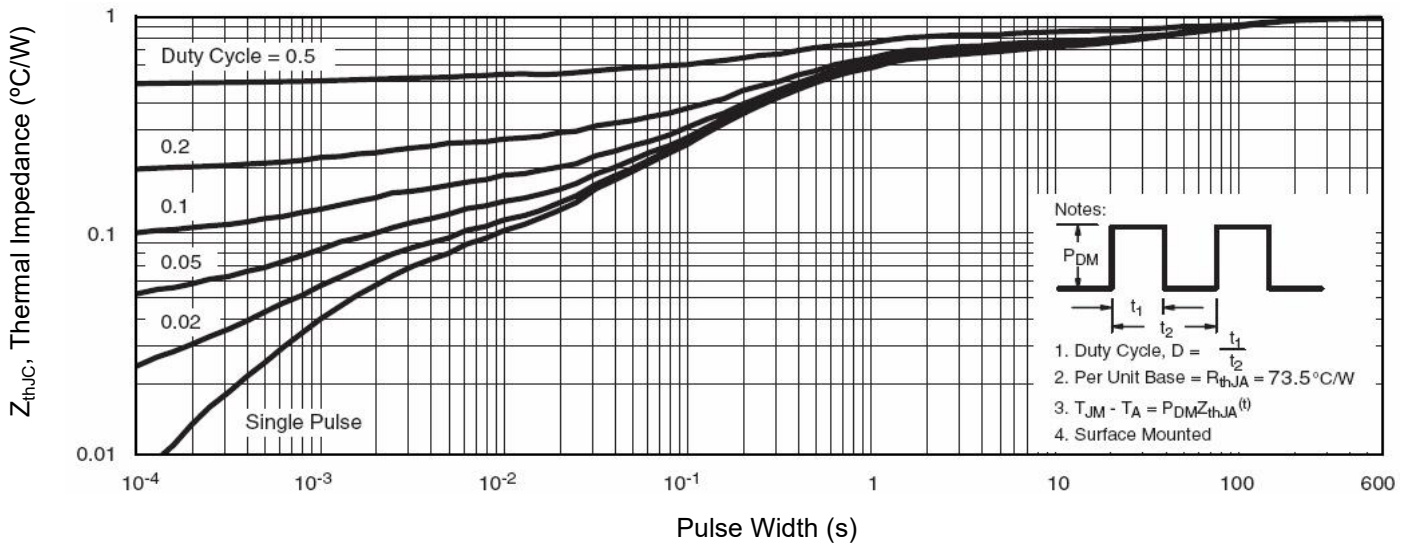
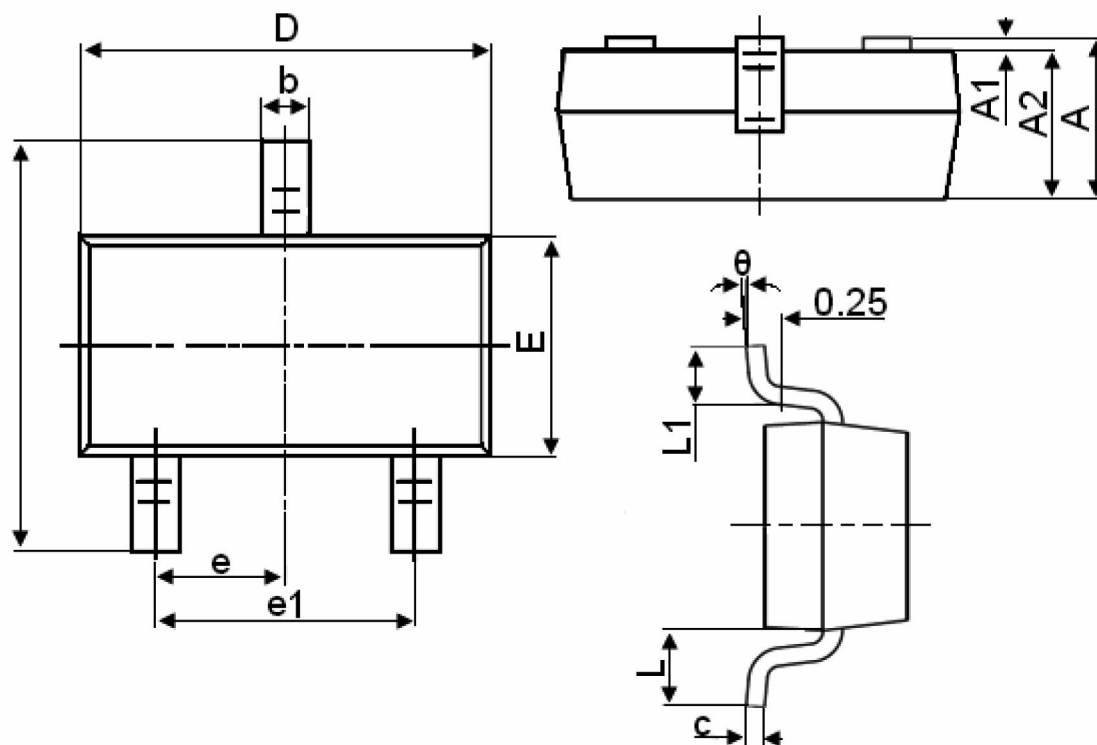

Figure 9. Normalized Maximum Transient Thermal Impedance



SOT-23 Package Information



Symbol	Dimensions in Millimeters	
	MIN.	MAX.
A	0.900	1.150
A1	0.000	0.100
A2	0.900	1.050
b	0.300	0.500
c	0.080	0.150
D	2.800	3.000
E	1.200	1.400
E1	2.250	2.550
e	0.950TYP	
e1	1.800	2.000
L	0.550REF	
L1	0.300	0.500
θ	0°	8°