

50 Ω ultra thin balun with integrated harmonic filter / conjugate match balun to ST BlueNRG-134 and BlueNRG-234

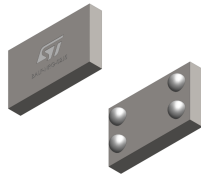

Flip-Chip (4 bumps) package

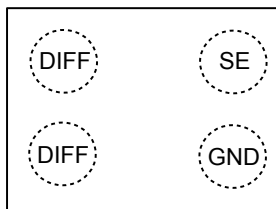

Top view

Product status link
[BALF-NRG-02J5](#)

Features

- 50 Ω nominal input / conjugate match to STMicroelectronics chips BlueNRG-134 WLCSP and BlueNRG-234 WLCSP
- Low insertion loss
- Low amplitude imbalance
- Low phase imbalance
- Ultraminiature footprint: < 1.2 mm²
- Extra low profile < 350 μ m after reflow
- High RF performance
- RF BOM and area reduction

Applications

- 2.45 GHz impedance matched balun filter
- Optimized for STMicroelectronics chip set BlueNRG-134 and BlueNRG-234 WLCSP
- Wearable applications

Description

This device is an ultraminiature extra thin balun that integrates matching network and harmonics filter.

Matching impedance has been customized for the BLUENRG-134 and BlueNRG-234 WLCSP from STMicroelectronics.

Based on IPD technology on high resistivity silicium it optimizes the RF performance.

STMicroelectronics qualified this product intended to be used in system in package module based on standard reliability procedure. For more details, please contact ST representatives.

It is the responsibility of the customer to perform qualification reliability verifications as it is related to customer specific application, mission profile and module design, process.

1 Characteristics

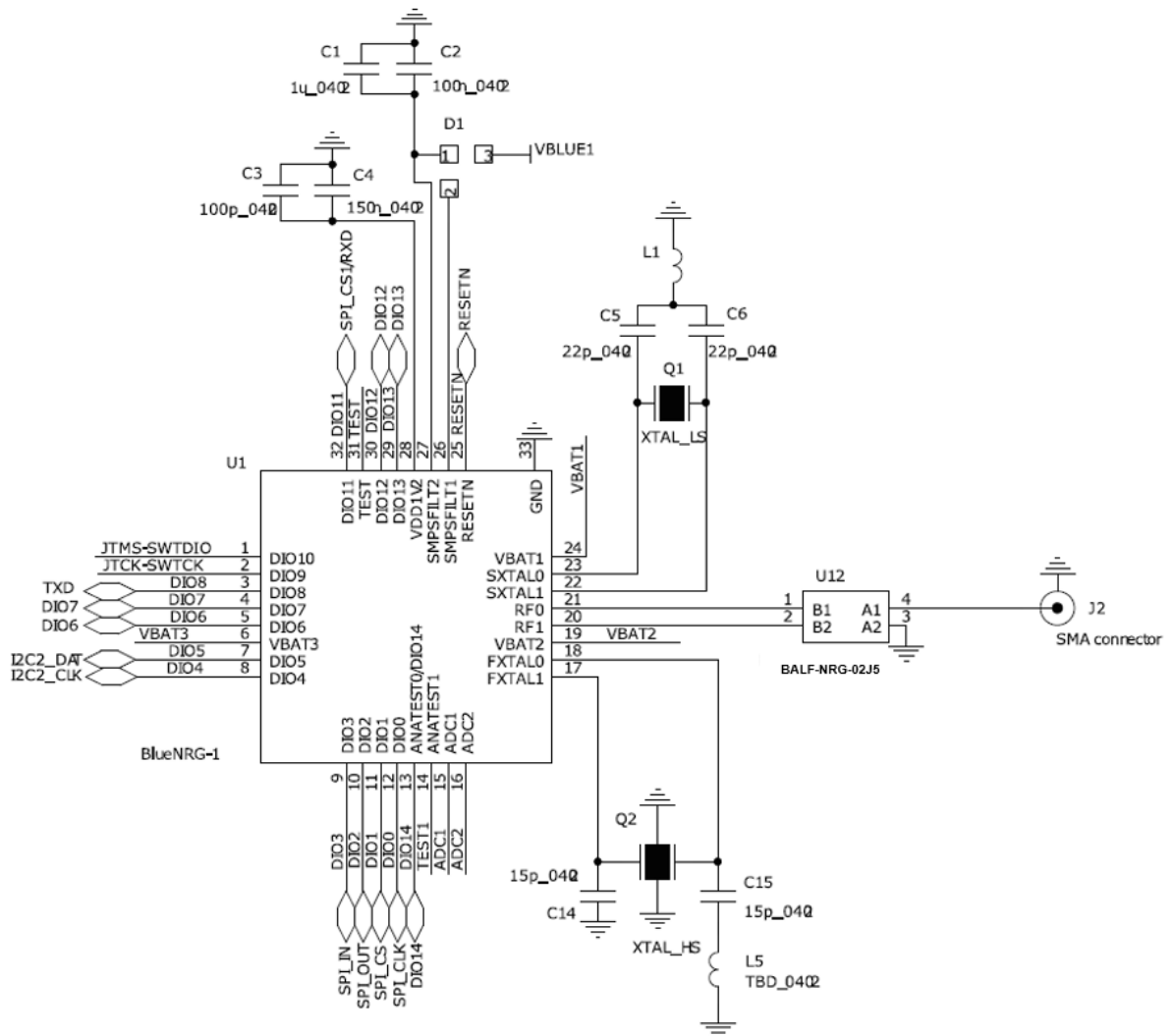
Figure 1. Application schematic

Table 1. Absolute ratings (limiting values)

Symbol	Parameter	Value			Unit
		Min.	Typ.	Max.	
P_{IN}	Input power RF_{IN}		-	10	dBm
V_{ESD}	ESD ratings human body model (JESD22-A114-C), all I/O one at a time while others connected to GND	2000	-		V
	ESD ratings charge device model (JESD22-C101-C)	500	-		
	ESD ratings machine model, all I/O	200	-		
T_{OP}	Operating temperature	-40	-	+105	°C

Table 2. Impedances ($T_{amb} = 25\text{ °C}$)

Symbol	Parameter	Value			Unit
		Min.	Typ.	Max.	
Z_{DIFF}	Nominal differential impedance	-	matched	-	Ω
Z_{SE}	Nominal single ended impedance	-	50	-	Ω

Table 3. RF performance ($T_{amb} = 25\text{ °C}$)

Symbol	Parameter	Value			Unit
		Min.	Typ.	Max.	
f	Frequency range (bandwidth)	2400		2500	MHz
I_L	Insertion loss in bandwidth (differential mode)		1.35	1.65	dB
RL_{SE}	Single ended return loss in bandwidth (differential mode)	26	34		dB
RL_{DIFF}	Differential return loss in bandwidth	18	24		dB
H2	Second harmonic attenuation (differential mode)	37	47		dB
H3	Third harmonic attenuation (differential mode)	50	56		dB
H4	Fourth harmonic attenuation (differential mode)	45	50		dB
H5	Fifth harmonic attenuation (differential mode)	39	60		dB
H6	Sixth harmonic attenuation (differential mode)	37	46		dB
H7	Seventh harmonic attenuation (differential mode)	38	58		dB
Φ_{imb}	Phase imbalance	-4.5		4.5	$^{\circ}$
A_{imb}	Amplitude imbalance	-1.1		+1.1	dB

1.1 On-board measurements

Figure 2. Return loss on SE port ($T_{amb} = 25\text{ °C}$)

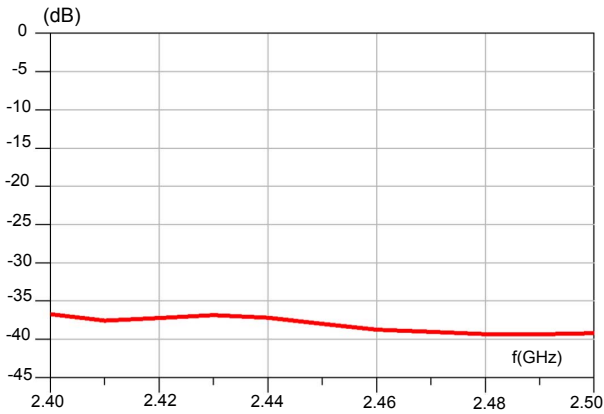

Figure 3. Return loss on DIFF port ($T_{amb} = 25\text{ °C}$)

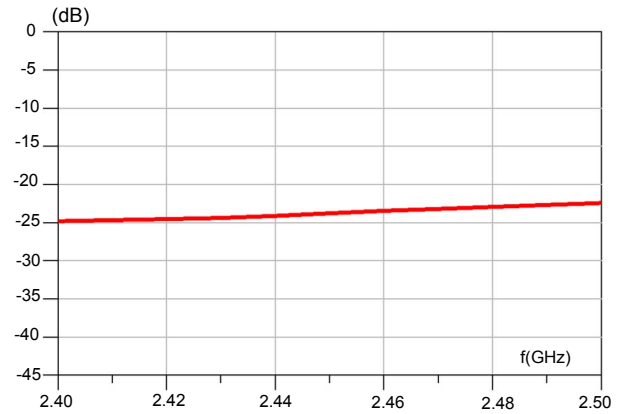

Figure 4. Transmission ($T_{amb} = 25\text{ °C}$)

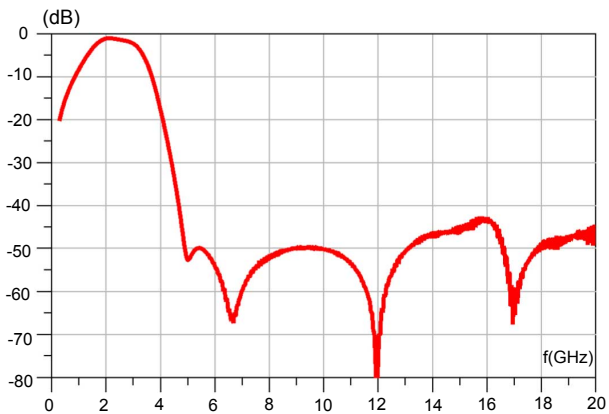

Figure 5. Insertion loss ($T_{amb} = 25\text{ °C}$)

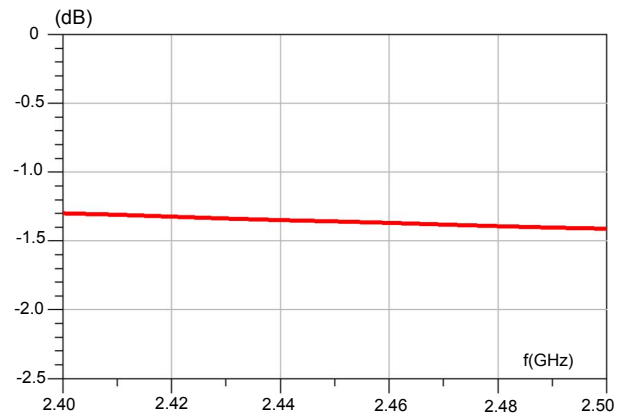

Figure 6. H2 attenuation ($T_{amb} = 25\text{ }^{\circ}\text{C}$)

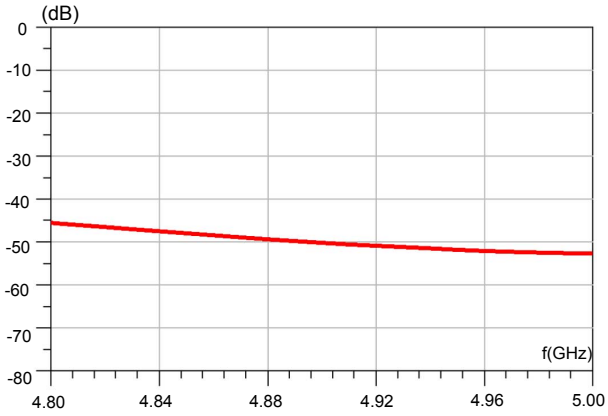

Figure 7. H3 attenuation ($T_{amb} = 25\text{ }^{\circ}\text{C}$)

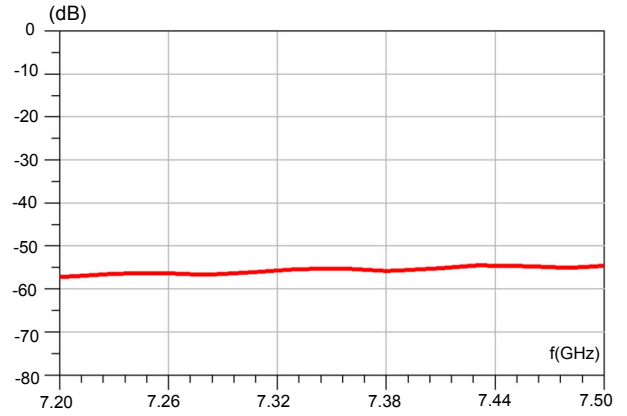

Figure 8. H4 attenuation ($T_{amb} = 25\text{ }^{\circ}\text{C}$)

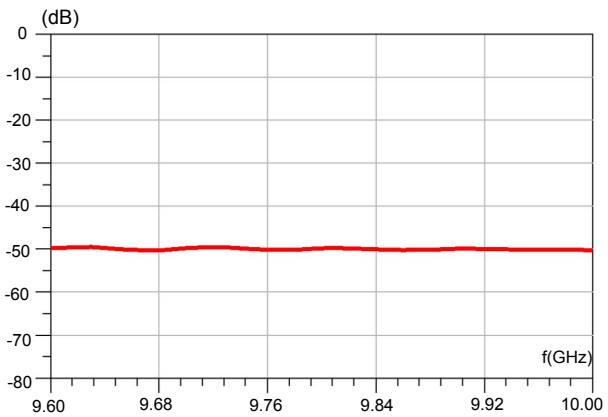

Figure 9. H5 attenuation ($T_{amb} = 25\text{ }^{\circ}\text{C}$)

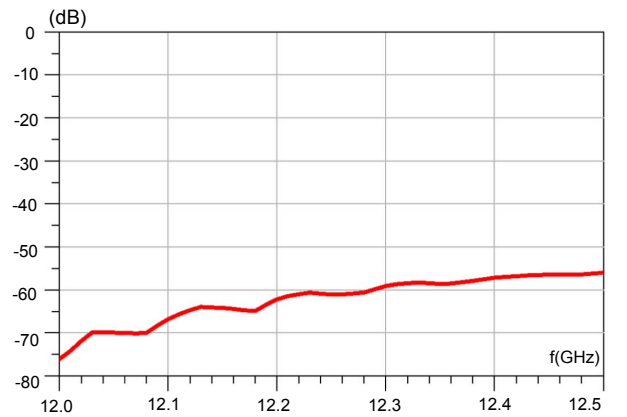

Figure 10. H6 attenuation ($T_{amb} = 25\text{ }^{\circ}\text{C}$)

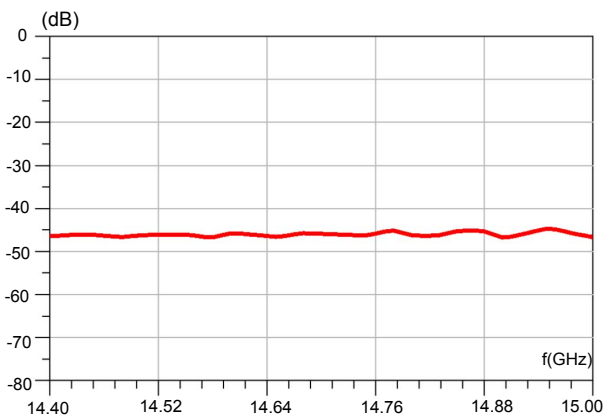

Figure 11. H7 attenuation ($T_{amb} = 25\text{ }^{\circ}\text{C}$)

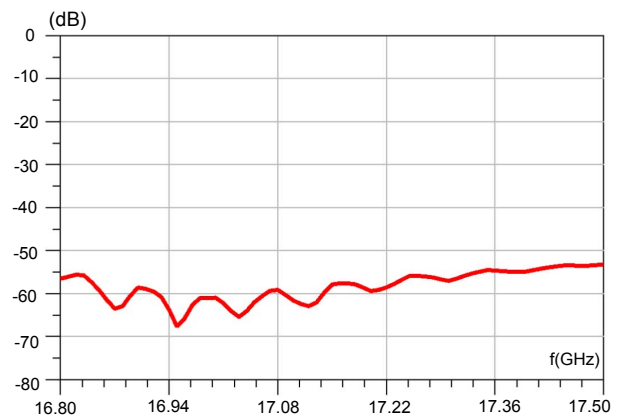

Figure 12. Amplitude imbalance ($T_{amb} = 25\text{ °C}$)

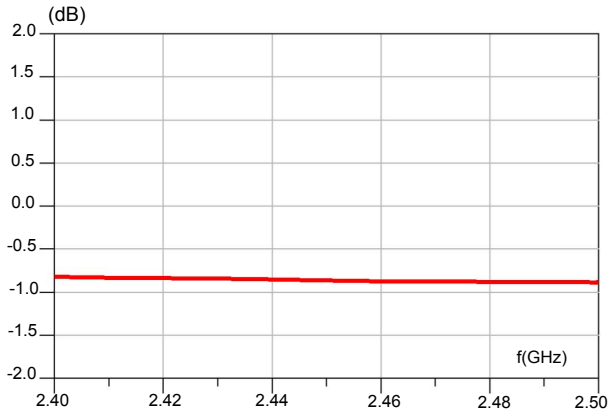
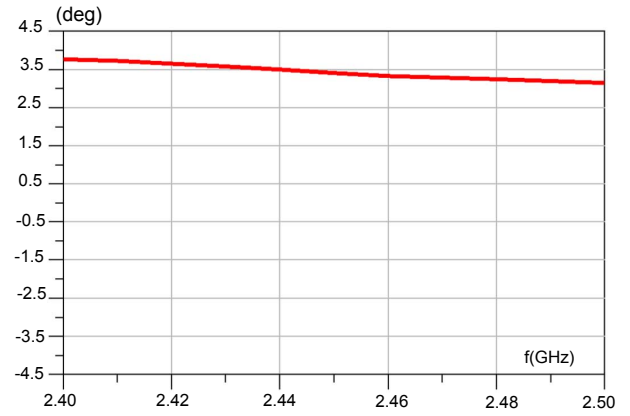

Figure 13. Phase imbalance ($T_{amb} = 25\text{ °C}$)



2 Package information

In order to meet environmental requirements, ST offers these devices in different grades of ECOPACK® packages, depending on their level of environmental compliance. ECOPACK® specifications, grade definitions and product status are available at: www.st.com. ECOPACK® is an ST trademark.

2.1 Ultra thin Flip-Chip 4 bumps package information

- Epoxy meets UL94, V0
- Lead-free package

Figure 14. Ultra thin Flip-Chip 4 bumps package outline

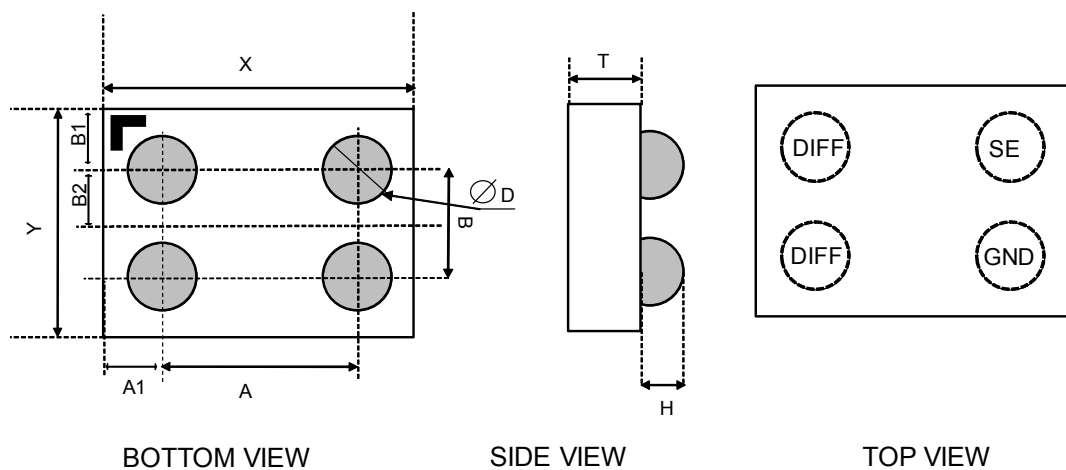
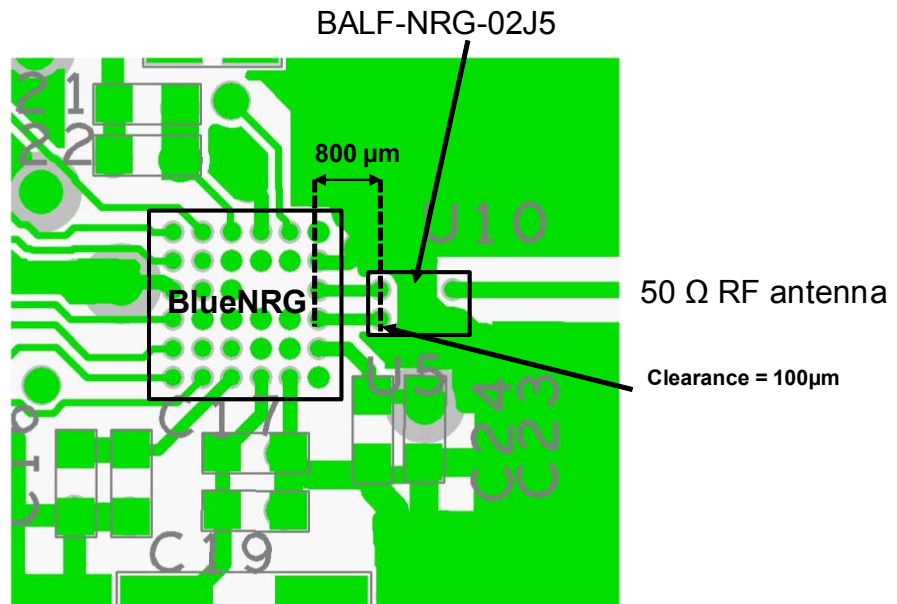
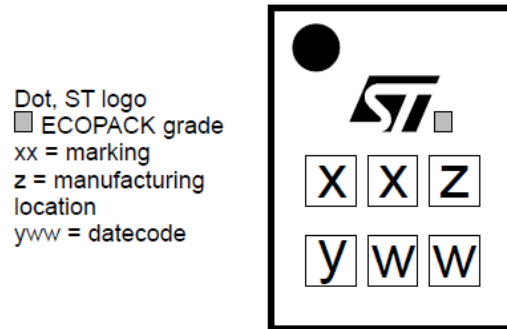

Table 4. Ultra thin Flip-Chip 4 bumps package mechanical data

Parameter	Description	Min.	Typ.	Max.	Unit
X	X dimension of the die	1355	1385	1415	μm
Y	Y dimension of the die	825	855	885	
A	X pitch		1000		
B	Y pitch		400		
A1	Distance from bump to edge of die on X axis		192.5		
B1	Distance from bump to edge of die on Y axis		227.5		
B2	Distance from bump to center of die on Y axis		200		
D	Bump diameter	202	227	252	
T	Substrate thickness	190	200	210	
H	Bump height	117	142	167	

Figure 15. Recommended land pattern

2.2 Ultra thin Flip-chip 4 bumps packing information

Figure 16. Marking

Note: More packing information is available in the application note:

- AN2348 Flip-Chip: "Package description and recommendations for use"

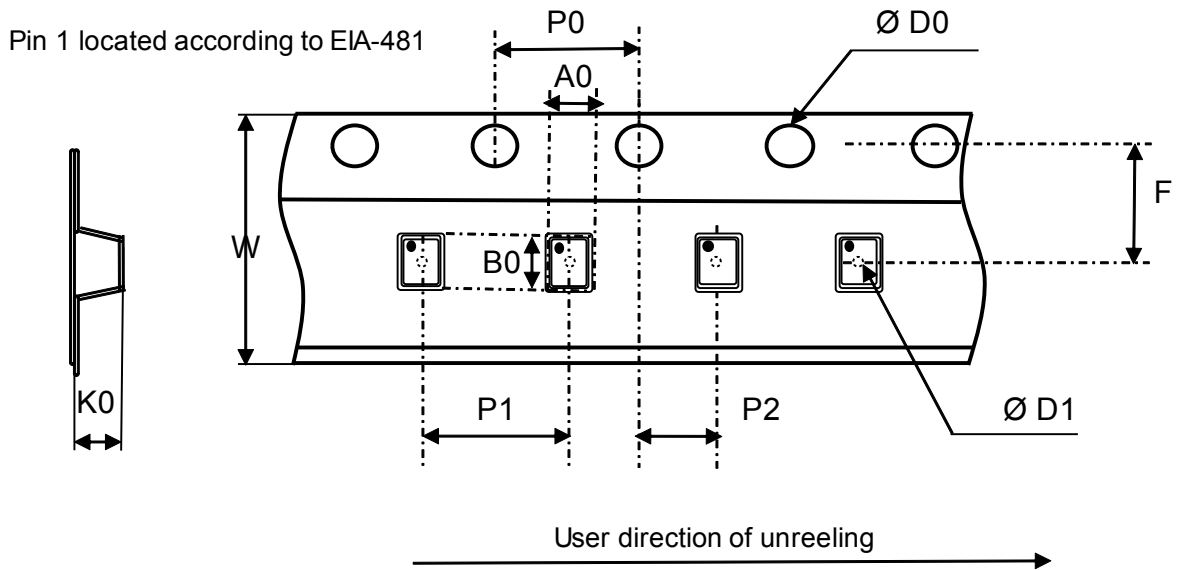
Figure 17. Flip Chip tape and reel specification

Note: Pocket dimensions are not on scale
Pocket shape may vary depending on package

Table 5. Ultra thin Flip-Chip 4 bumps package mechanical data

Ref.	Dimensions		
	Millimeters		
	Min.	Typ.	Max.
A0	0.91	0.96	1.01
B0	1.44	1.49	1.54

Ref.	Dimensions		
	Millimeters		
	Min.	Typ.	Max.
P1	3.90	4.00	4.10
P0	3.90	4.00	4.10
Ø D0	1.40	1.50	1.60
Ø D1	0.15	0.20	0.25
F	3.45	3.50	3.55
K0	0.38	0.43	0.48
P2	1.95	2.00	2.05
W	7.90	8.00	8.30

Figure 18. Footprint - non solder mask defined

Copper pad diameter:
 220 µm recommended
 180 µm minimum
 260 µm maximum

Solder mask opening:
 320 µm recommended
 300 µm minimum
 340 µm maximum

Solder stencil opening:
 220 µm recommended

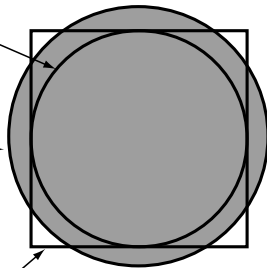
Figure 19. Footprint - solder mask defined

Solder mask opening:
 220 µm recommended
 180 µm minimum
 260 µm maximum

Copper pad diameter:
 320 µm recommended
 300 µm minimum

Solder stencil opening:
 220 µm recommended

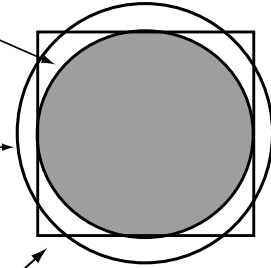

3 Ordering information

Figure 20. Ordering information scheme

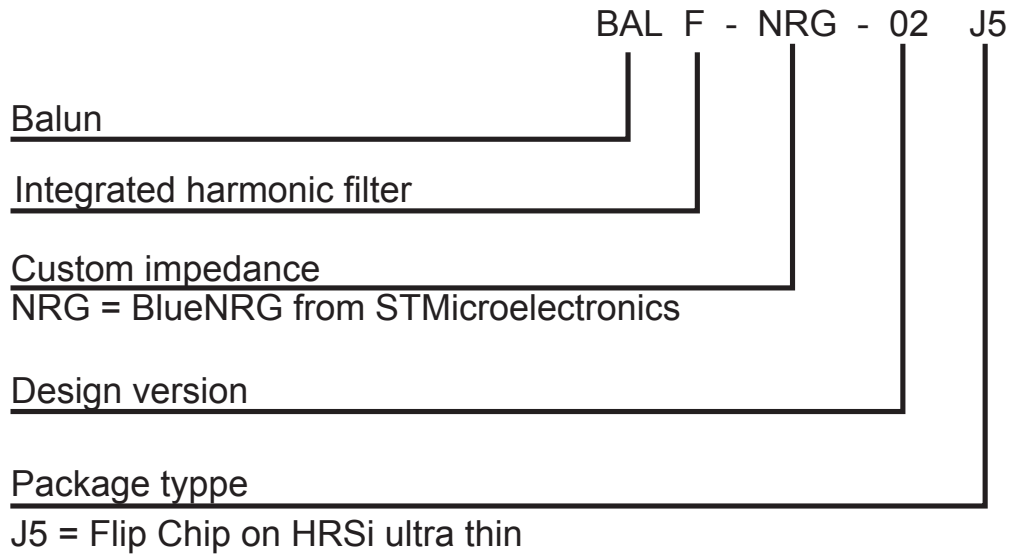

Table 6. Ordering information

Order code	Marking	Package	Weight	Base qty.	Delivery mode
BALF-NRG-02J5	TP	Flip-Chip 4 bumps	0.645 mg	5000	Tape and reel

Revision history

Table 7. Document revision history

Date	Revision	Changes
12-Jul-2018	1	Initial release.

IMPORTANT NOTICE – PLEASE READ CAREFULLY

STMicroelectronics NV and its subsidiaries (“ST”) reserve the right to make changes, corrections, enhancements, modifications, and improvements to ST products and/or to this document at any time without notice. Purchasers should obtain the latest relevant information on ST products before placing orders. ST products are sold pursuant to ST’s terms and conditions of sale in place at the time of order acknowledgement.

Purchasers are solely responsible for the choice, selection, and use of ST products and ST assumes no liability for application assistance or the design of Purchasers’ products.

No license, express or implied, to any intellectual property right is granted by ST herein.

Resale of ST products with provisions different from the information set forth herein shall void any warranty granted by ST for such product.

ST and the ST logo are trademarks of ST. All other product or service names are the property of their respective owners.

Information in this document supersedes and replaces information previously supplied in any prior versions of this document.

© 2018 STMicroelectronics – All rights reserved