

Mounting Option

08-#4-40 Unified Threaded Inserts

Contact Detail

524-P.C. Tail .018 Sq.(0.46 Sq.) - Tail LG=.185(4.70)
 .100 [2.54] Contact Spacing x .200 [5.08] Row Spacing

THIS IS A C.A.D. GENERATED DRAWING
 DO NOT MAKE MANUAL REVISIONS TO MASTER.



ISSUE NUMBER

ORIGINAL

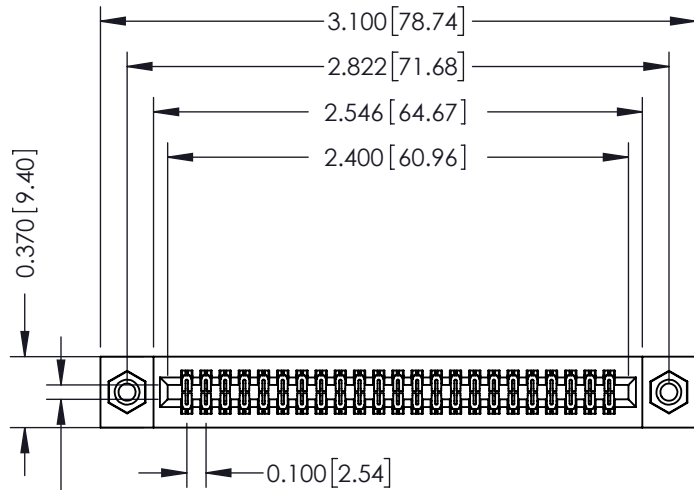

Card Slot Accepts
 .054 [1.37] to .070 [1.78]
 Thick P.C. Board

A

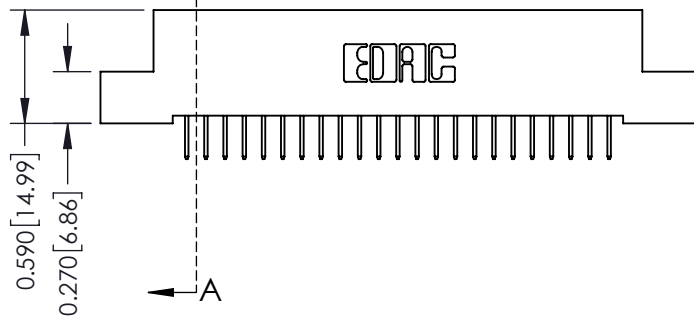

A

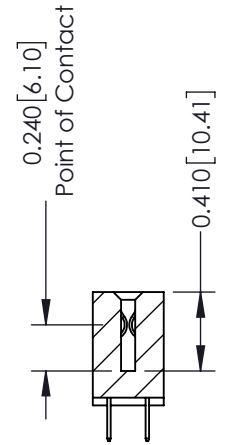

SECTION A-A

See Accompanying Pages for:

- Contact Bend Details
- Mounting Options

342 / 392 Card Edge Connector

Part Number: 392-046-524-208



EDAC INC
 TORONTO, ONTARIO
 CANADA

YOUR CONNECTION TO QUALITY & SERVICE

THESE DRAWINGS AND SPECIFICATIONS
 ARE THE PROPERTY OF EDAC INC. AND
 SHALL NOT BE REPRODUCED, OR COPIED
 OR USED AS THE BASIS FOR THE
 MANUFACTURE OR SALE OF APPARATUS
 WITHOUT WRITTEN PERMISSION.

ACAD REFERENCE NO. 342 ENG MASTER

DRAWN: J.LEE DATE: OCT. 06/09

CHECKED: DATE:

SCALE: NTS SHEET 1 OF 3

DRAWING NUMBER ISSUE

342 Assembly

1



555 Contact Code



556 Contact Code



558 Contact Code



559 Contact Code



560 Contact Code

342 / 392 Series Card Edge Connector
Contact Bend Detail

ACAD REFERENCE NO. 342 ENG MASTER

DRAWN: J.LEE DATE: OCT. 06/09

CHECKED: DATE:

SCALE: NTS SHEET 2 OF 3

DRAWING NUMBER ISSUE

342 Assembly

1



EDAC INC
TORONTO, ONTARIO
CANADA

YOUR CONNECTION TO QUALITY & SERVICE

THESE DRAWINGS AND SPECIFICATIONS
ARE THE PROPERTY OF EDAC INC. AND
SHALL NOT BE REPRODUCED, OR COPIED
OR USED AS THE BASIS FOR THE
MANUFACTURE OR SALE OF APPARATUS
WITHOUT WRITTEN PERMISSION.

THIS IS A C.A.D. GENERATED DRAWING
DO NOT MAKE MANUAL REVISIONS TO MASTER.



ISSUE NUMBER

ORIGINAL



342 / 392 Card Edge Connector Mounting Options		ACAD REFERENCE NO. 342 ENG MASTER	
		DRAWN: J.LEE	DATE: OCT. 06/09
 EDAC INC TORONTO, ONTARIO CANADA YOUR CONNECTION TO QUALITY & SERVICE		CHECKED: DATE:	
		SCALE: NTS	SHEET 3 OF 3
THESE DRAWINGS AND SPECIFICATIONS ARE THE PROPERTY OF EDAC INC. AND SHALL NOT BE REPRODUCED, OR COPIED OR USED AS THE BASIS FOR THE MANUFACTURE OR SALE OF APPARATUS WITHOUT WRITTEN PERMISSION.		DRAWING NUMBER	
		342 Assembly	
		ISSUE	
		1	