

## Data sheet | Item number: 2020-1301

2-conductor/1-pin carrier terminal block; for DIN-rail 35 x 15 and 35 x 7.5;  
Push-in CAGE CLAMP®; 1,00 mm²; gray

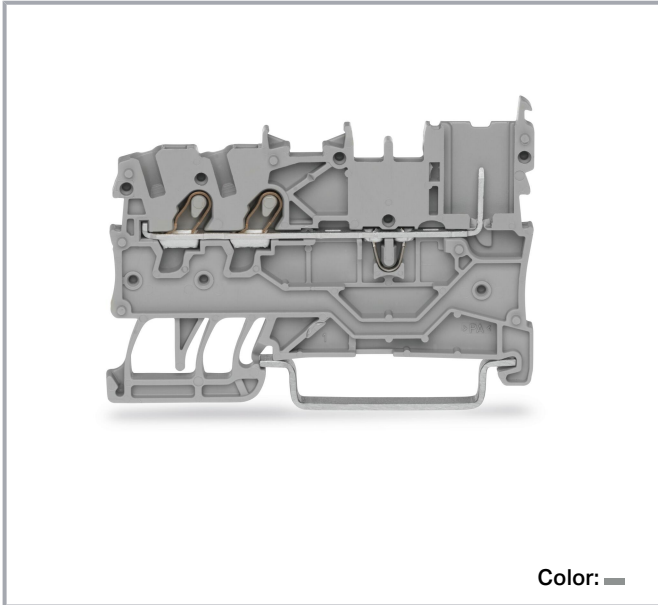

[www.wago.com/2020-1301](http://www.wago.com/2020-1301)



Color: —

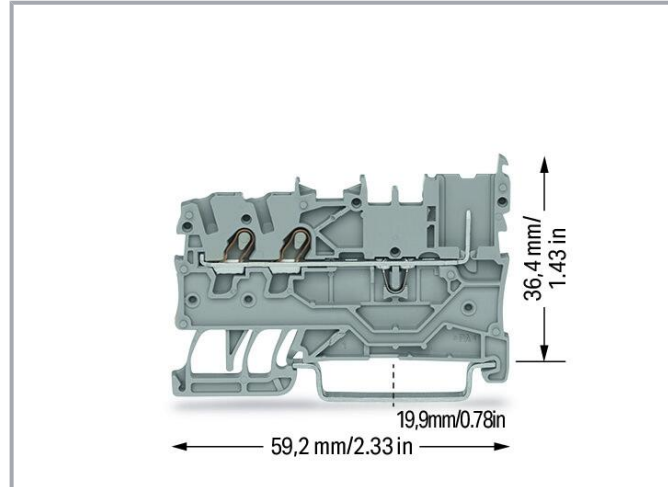

### Data

#### Electrical data

#### Ratings per IEC/EN

Ratings per	IEC/EN 60947-7-1
Nominal voltage (III/3)	500 V
Rated impulse voltage (III/3)	6 kV
Rated current	13.5 A
Legend (ratings)	(III / 3) ≙ Overvoltage category III / Pollution degree 3

#### Ratings per UL 1059

Approvals per	UL 1059
Rated voltage UL (Use Group B)	300 V
Rated current UL (Use Group B)	15 A
Rated voltage UL (Use Group C)	300 V
Rated current UL (Use Group C)	15 A

Subject to changes. Please also observe the further product documentation!

WAGO GmbH & Co. KG  
Hansastr. 27  
32423 Minden  
Phone: +49571 887-0 | Fax: +49571 887-169  
Email: [info.de@wago.com](mailto:info.de@wago.com) | Web: [www.wago.com](http://www.wago.com)

Do you have any questions about our products?  
We are always happy to take your call at +49 (571) 887-44222.



Rated voltage UL (Use Group D)	300 V
Rated current UL (Use Group D)	15 A

### Ratings per CSA

Approvals per	CSA 22.2 No 158
Rated voltage CSA (Use Group B)	300 V
Rated current CSA (Use Group B)	10 A
Rated voltage CSA (Use Group C)	300 V
Rated current CSA (Use Group C)	10 A
Rated voltage CSA (Use Group D)	300 V
Rated current CSA (Use Group D)	10 A

### Power loss

Power loss, per pole (potential)	0.434 W
Rated current $I_N$ for specified power loss	13.5 A
Resistance value for specified, current-dependent power loss	0.002 $\Omega$

### Connection data

Connection points	2
Female plug slots	1
Total number of potentials	1
Number of levels	1

### Connection 1

Connection technology	Push-in CAGE CLAMP <sup>®</sup>
Actuation type	Operating tool
Connectable conductor materials	Copper
Nominal cross-section	1 mm <sup>2</sup>
Solid conductor	0.14 ... 1.5 mm <sup>2</sup> / 24 ... 16 AWG
Solid conductor; push-in termination	0.5 ... 1.5 mm <sup>2</sup> / 20 ... 16 AWG
Fine-stranded conductor	0.14 ... 1.5 mm <sup>2</sup> / 24 ... 16 AWG
Fine-stranded conductor; with insulated ferrule	0.14 ... 0.75 mm <sup>2</sup> / 24 ... 18 AWG
Fine-stranded conductor; with ferrule; push-in termination	0.5 ... 0.75 mm <sup>2</sup> / 20 ... 18 AWG
Note (conductor cross-section)	Depending on the conductor characteristic, a conductor with a smaller cross-section can also be inserted via push-in termination.
Strip length	9 ... 11 mm / 0.35 ... 0.43 inches

Subject to changes. Please also observe the further product documentation!



Wiring direction	Front-entry wiring
------------------	--------------------

## Physical data

Width	3.5 mm / 0.138 inches
Height	59.2 mm / 2.331 inches
Depth from upper-edge of DIN-rail	36.4 mm / 1.433 inches

## Mechanical Data

Mounting type	DIN-35 rail
Marking level	Center/side marking

## Material Data

Note (material data)	Information on material specifications can be found here
Color	gray
Material group	I
Insulation material	Polyamide (PA66)
Flammability class per UL94	V0
Fire load	0.1 MJ
Weight	4.5 g

## Environmental requirements

Processing temperature	-35 ... +85 °C
Continuous operating temperature	-60 ... +105 °C

## Commercial data

eCl@ss 10.0	27-14-11-20
eCl@ss 9.0	27-14-11-20
ETIM 8.0	EC000897
ETIM 7.0	EC000897
PU (SPU)	50 pcs
Packaging type	Box
Country of origin	CN
GTIN	4055143288125
Customs tariff number	85366990990

Subject to changes. Please also observe the further product documentation!

WAGO GmbH & Co. KG  
 Hansastr. 27  
 32423 Minden  
 Phone: +49571 887-0 | Fax: +49571 887-169  
 Email: [info.de@wago.com](mailto:info.de@wago.com) | Web: [www.wago.com](http://www.wago.com)

Do you have any questions about our products?  
 We are always happy to take your call at +49 (571) 887-44222.





## Environmental Product Compliance

RoHS Compliance Status



Compliant, No Exemption

## Approvals / Certificates

### General approvals

Logo	Approval	Additional Approval Text	Certificate name
	CCA DEKRA Certification B.V.	EN 60947	NTR NL 7617
	CSA DEKRA Certification B.V.	C22.2	2516073
	KEMA/KEUR DEKRA Certification B.V.	EN 60947	71- 100670
	UL UL International Germany GmbH	UL 1059	E 45172

### Declarations of conformity and manufacturer's declarations

Logo	Approval	Additional Approval Text	Certificate name
	EU-Declaration of Conformity WAGO GmbH & Co. KG	-	-
	UK-Declaration of Conformity WAGO GmbH & Co. KG	-	-

### Counterpart

	Item no.2020-102 1-conductor female connector; Push-in CAGE CLAMP®; 1.5 mm <sup>2</sup> ; Pin spacing 3.5 mm; 2-pole; 1,50 mm <sup>2</sup> ; gray	<a href="http://www.wago.com/2020-102">www.wago.com/2020-102</a>
	Item no.2020-202	

Subject to changes. Please also observe the further product documentation!



2-conductor female connector; Push-in CAGE CLAMP®; 1.5 mm<sup>2</sup>; Pin spacing 3.5 mm; 2-pole; 1,50 mm<sup>2</sup>; gray [www.wago.com/2020-202](http://www.wago.com/2020-202)

## Required accessories

### End plate

#### End plate



**Item no.: 2020-1391**  
End and intermediate plate; 1 mm thick; gray

[www.wago.com/2020-1391](http://www.wago.com/2020-1391)



**Item no.: 2020-1392**  
End and intermediate plate; 1 mm thick; orange

[www.wago.com/2020-1392](http://www.wago.com/2020-1392)

## Optional accessories

### Coding

#### Coding



**Item no.: 2020-100**  
Carrier with 6 coding pins; for coding of female plugs; for carrier terminal blocks; orange

[www.wago.com/2020-100](http://www.wago.com/2020-100)

### Push-in type wire jumper

#### Jumper



**Item no.: 2009-404**  
Push-in type wire jumper; 0.75 mm<sup>2</sup>; insulated; 110 mm long; gray

[www.wago.com/2009-404](http://www.wago.com/2009-404)



**Item no.: 2009-402**  
Push-in type wire jumper; 0.75 mm<sup>2</sup>; insulated; 60 mm long; gray

[www.wago.com/2009-402](http://www.wago.com/2009-402)



**Item no.: 2009-406**  
Push-in type wire jumper; 0.75 mm<sup>2</sup>; insulated; 250 mm long; gray

[www.wago.com/2009-406](http://www.wago.com/2009-406)

### Jumpers

#### Jumper



**Item no.: 210-123**  
Wire commoning chain; insulated; blue

[www.wago.com/210-123](http://www.wago.com/210-123)



**Item no.: 2000-408**  
Jumper; 8-way; insulated; light gray

[www.wago.com/2000-408](http://www.wago.com/2000-408)



**Item no.: 2000-407**  
Jumper; 7-way; insulated; light gray

[www.wago.com/2000-407](http://www.wago.com/2000-407)



**Item no.: 2000-409**  
Jumper; 9-way; insulated; light gray

[www.wago.com/2000-409](http://www.wago.com/2000-409)

Subject to changes. Please also observe the further product documentation!

WAGO GmbH & Co. KG

Hansastr. 27

32423 Minden

Phone: +49571 887-0 | Fax: +49571 887-169

Email: [info.de@wago.com](mailto:info.de@wago.com) | Web: [www.wago.com](http://www.wago.com)

Do you have any questions about our products?

We are always happy to take your call at +49 (571) 887-44222.



**Item no.:** 2000-408/000-006  
Jumper; 8-way; insulated; blue

[www.wago.com/2000-408/000-006](http://www.wago.com/2000-408/000-006)



**Item no.:** 2000-408/000-005  
Jumper; 8-way; insulated; red

[www.wago.com/2000-408/000-005](http://www.wago.com/2000-408/000-005)



**Item no.:** 2000-409/000-005  
Jumper; 9-way; insulated; red

[www.wago.com/2000-409/000-005](http://www.wago.com/2000-409/000-005)



**Item no.:** 2000-407/000-006  
Jumper; 7-way; insulated; blue

[www.wago.com/2000-407/000-006](http://www.wago.com/2000-407/000-006)



**Item no.:** 2000-410  
Jumper; 10-way; insulated; light gray

[www.wago.com/2000-410](http://www.wago.com/2000-410)



**Item no.:** 2000-410/000-006  
Jumper; 10-way; insulated; blue

[www.wago.com/2000-410/000-006](http://www.wago.com/2000-410/000-006)



**Item no.:** 2000-433/000-005  
Jumper; from 1 to 3; insulated; red

[www.wago.com/2000-433/000-005](http://www.wago.com/2000-433/000-005)



**Item no.:** 2000-407/000-005  
Jumper; 7-way; insulated; red

[www.wago.com/2000-407/000-005](http://www.wago.com/2000-407/000-005)



**Item no.:** 2000-433/000-006  
Jumper; from 1 to 3; insulated; blue

[www.wago.com/2000-433/000-006](http://www.wago.com/2000-433/000-006)



**Item no.:** 2000-410/000-005  
Jumper; 10-way; insulated; red

[www.wago.com/2000-410/000-005](http://www.wago.com/2000-410/000-005)



**Item no.:** 2000-435  
Jumper; from 1 to 5; insulated; light gray

[www.wago.com/2000-435](http://www.wago.com/2000-435)



**Item no.:** 2000-409/000-006  
Jumper; 9-way; insulated; blue

[www.wago.com/2000-409/000-006](http://www.wago.com/2000-409/000-006)



**Item no.:** 2000-436  
Jumper; from 1 to 6; insulated; light gray

[www.wago.com/2000-436](http://www.wago.com/2000-436)



**Item no.:** 2000-433

Subject to changes. Please also observe the further product documentation!

	Jumper; from 1 to 3; insulated; light gray	<a href="http://www.wago.com/2000-433">www.wago.com/2000-433</a>
	<b>Item no.: 2000-434</b> Jumper; from 1 to 4; insulated; light gray	<a href="http://www.wago.com/2000-434">www.wago.com/2000-434</a>
	<b>Item no.: 2000-402</b> Jumper; 2-way; insulated; light gray	<a href="http://www.wago.com/2000-402">www.wago.com/2000-402</a>
	<b>Item no.: 2000-402/000-006</b> Jumper; 2-way; insulated; blue	<a href="http://www.wago.com/2000-402/000-006">www.wago.com/2000-402/000-006</a>
	<b>Item no.: 2000-403</b> Jumper; 3-way; insulated; light gray	<a href="http://www.wago.com/2000-403">www.wago.com/2000-403</a>
	<b>Item no.: 2000-402/000-005</b> Jumper; 2-way; insulated; red	<a href="http://www.wago.com/2000-402/000-005">www.wago.com/2000-402/000-005</a>
	<b>Item no.: 2000-402/000-018</b> Jumper; 2-way; insulated; yellow-green	<a href="http://www.wago.com/2000-402/000-018">www.wago.com/2000-402/000-018</a>
	<b>Item no.: 2000-404</b> Jumper; 4-way; insulated; light gray	<a href="http://www.wago.com/2000-404">www.wago.com/2000-404</a>
	<b>Item no.: 2000-403/000-005</b> Jumper; 3-way; insulated; red	<a href="http://www.wago.com/2000-403/000-005">www.wago.com/2000-403/000-005</a>
	<b>Item no.: 2000-404/000-006</b> Jumper; 4-way; insulated; blue	<a href="http://www.wago.com/2000-404/000-006">www.wago.com/2000-404/000-006</a>
	<b>Item no.: 2000-403/000-006</b> Jumper; 3-way; insulated; blue	<a href="http://www.wago.com/2000-403/000-006">www.wago.com/2000-403/000-006</a>
	<b>Item no.: 2000-404/000-005</b> Jumper; 4-way; insulated; red	<a href="http://www.wago.com/2000-404/000-005">www.wago.com/2000-404/000-005</a>
	<b>Item no.: 2000-405</b> Jumper; 5-way; insulated; light gray	<a href="http://www.wago.com/2000-405">www.wago.com/2000-405</a>
	<b>Item no.: 2000-405/011-000</b> Star point jumper; 3-way; insulated; light gray	<a href="http://www.wago.com/2000-405/011-000">www.wago.com/2000-405/011-000</a>
	<b>Item no.: 2000-405/000-006</b> Jumper; 5-way; insulated; blue	<a href="http://www.wago.com/2000-405/000-006">www.wago.com/2000-405/000-006</a>

Subject to changes. Please also observe the further product documentation!



**Item no.: 2000-406/000-006**  
Jumper; 6-way; insulated; blue

[www.wago.com/2000-406/000-006](http://www.wago.com/2000-406/000-006)



**Item no.: 2000-405/000-005**  
Jumper; 5-way; insulated; red

[www.wago.com/2000-405/000-005](http://www.wago.com/2000-405/000-005)



**Item no.: 2000-406**  
Jumper; 6-way; insulated; light gray

[www.wago.com/2000-406](http://www.wago.com/2000-406)



**Item no.: 2000-406/000-005**  
Jumper; 6-way; insulated; red

[www.wago.com/2000-406/000-005](http://www.wago.com/2000-406/000-005)



**Item no.: 2000-406/020-000**  
Delta jumper; insulated; light gray

[www.wago.com/2000-406/020-000](http://www.wago.com/2000-406/020-000)



**Item no.: 2000-437**  
Jumper; from 1 to 7; insulated; light gray

[www.wago.com/2000-437](http://www.wago.com/2000-437)



**Item no.: 2000-438**  
Jumper; from 1 to 8; insulated; light gray

[www.wago.com/2000-438](http://www.wago.com/2000-438)



**Item no.: 2000-439**  
Jumper; from 1 to 9; insulated; light gray

[www.wago.com/2000-439](http://www.wago.com/2000-439)



**Item no.: 2000-440**  
Jumper; from 1 to 10; insulated; light gray

[www.wago.com/2000-440](http://www.wago.com/2000-440)



**Item no.: 210-103**  
Wire commoning chain; insulated; black

[www.wago.com/210-103](http://www.wago.com/210-103)

## Testing and measuring

### Testing accessories



**Item no.: 2009-174**  
Test plug adapter; for 4 mm Ø test plugs; for testing TOPJOB®S rail-mounted terminal blocks; gray

[www.wago.com/2009-174](http://www.wago.com/2009-174)



**Item no.: 2009-182**  
Testing tap; for max. 2.5 mm<sup>2</sup>; tool-free connection for individual test wires 0.08 - 2.5 mm; gray

[www.wago.com/2009-182](http://www.wago.com/2009-182)



**Item no.: 2000-510**  
TOPJOB®S L-type test plug module; modular; for jumper contact slot; 1,00 mm<sup>2</sup>; gray

[www.wago.com/2000-510](http://www.wago.com/2000-510)



**Item no.: 2000-511**  
TOPJOB®S L-type test plug module; modular; for jumper contact slot; 1-pole; 1,00 mm<sup>2</sup>; gray

[www.wago.com/2000-511](http://www.wago.com/2000-511)

















**Item no.: 2000-549**  
Spacer module; modular; e.g., for bridging commoned terminal blocks; gray

[www.wago.com/2000-549](http://www.wago.com/2000-549)

Subject to changes. Please also observe the further product documentation!



	<b>Item no.: 2000-555</b> Modular TOPJOB®S connector; modular; for jumper contact slot; 5-pole; 1,00 mm <sup>2</sup> ; gray	<a href="http://www.wago.com/2000-555">www.wago.com/2000-555</a>
	<b>Item no.: 2000-553</b> Modular TOPJOB®S connector; modular; for jumper contact slot; 3-pole; 1,00 mm <sup>2</sup> ; gray	<a href="http://www.wago.com/2000-553">www.wago.com/2000-553</a>
	<b>Item no.: 2000-556</b> Modular TOPJOB®S connector; modular; for jumper contact slot; 6-pole; 1,00 mm <sup>2</sup> ; gray	<a href="http://www.wago.com/2000-556">www.wago.com/2000-556</a>
	<b>Item no.: 2000-558</b> Modular TOPJOB®S connector; modular; for jumper contact slot; 8-pole; 1,00 mm <sup>2</sup> ; gray	<a href="http://www.wago.com/2000-558">www.wago.com/2000-558</a>
	<b>Item no.: 2000-559</b> Modular TOPJOB®S connector; modular; for jumper contact slot; 9-pole; 1,00 mm <sup>2</sup> ; gray	<a href="http://www.wago.com/2000-559">www.wago.com/2000-559</a>
	<b>Item no.: 2000-552</b> Modular TOPJOB®S connector; modular; for jumper contact slot; 2-pole; 1,00 mm <sup>2</sup> ; gray	<a href="http://www.wago.com/2000-552">www.wago.com/2000-552</a>
	<b>Item no.: 2000-560</b> Modular TOPJOB®S connector; modular; for jumper contact slot; 10-pole; 1,00 mm <sup>2</sup> ; gray	<a href="http://www.wago.com/2000-560">www.wago.com/2000-560</a>
	<b>Item no.: 2000-554</b> Modular TOPJOB®S connector; modular; for jumper contact slot; 4-pole; 1,00 mm <sup>2</sup> ; gray	<a href="http://www.wago.com/2000-554">www.wago.com/2000-554</a>
	<b>Item no.: 2000-557</b> Modular TOPJOB®S connector; modular; for jumper contact slot; 7-pole; 1,00 mm <sup>2</sup> ; gray	<a href="http://www.wago.com/2000-557">www.wago.com/2000-557</a>
	<b>Item no.: 859-500</b> WAGO Test pin; 1 mm Ø; 30 V AC / 60 V DC; CAT0; 1 A; 10 mm uninsulated; Test lead for soldering up to 0,5mm <sup>2</sup>	<a href="http://www.wago.com/859-500">www.wago.com/859-500</a>
<b>Marking accessories</b>		
Marking strip		
	<b>Item no.: 2009-110</b> Marking strips; for Smart Printer; on reel; not stretchable; plain; snap-on type; white	<a href="http://www.wago.com/2009-110">www.wago.com/2009-110</a>
Marker		
	<b>Item no.: 2009-113</b> WMB-Inline; for Smart Printer; 2300 pieces on roll; plain; snap-on type; white	<a href="http://www.wago.com/2009-113">www.wago.com/2009-113</a>
	<b>Item no.: 793-3501</b> WMB marking card; as card; plain; snap-on type; white	<a href="http://www.wago.com/793-3501">www.wago.com/793-3501</a>
<b>Carrier rail</b>		
Mounting accessories		
	<b>Item no.: 210-197</b> Steel carrier rail; 35 x 15 mm; 1.5 mm thick; 2 m long; slotted; similar to EN 60715; silver-colored	<a href="http://www.wago.com/210-197">www.wago.com/210-197</a>
	<b>Item no.: 210-198</b>	

Subject to changes. Please also observe the further product documentation!

	Copper carrier rail; 35 x 15 mm; 2.3 mm thick; 2 m long; unslotted; according to EN 60715; copper-colored	<a href="http://www.wago.com/210-198">www.wago.com/210-198</a>
	<b>Item no.: 210-113</b> Steel carrier rail; 35 x 7.5 mm; 1 mm thick; 2 m long; unslotted; according to EN 60715; silver-colored	<a href="http://www.wago.com/210-113">www.wago.com/210-113</a>
	<b>Item no.: 210-118</b> Steel carrier rail; 35 x 15 mm; 2.3 mm thick; 2 m long; unslotted; according to EN 60715; silver-colored	<a href="http://www.wago.com/210-118">www.wago.com/210-118</a>
	<b>Item no.: 210-112</b> Steel carrier rail; 35 x 7.5 mm; 1 mm thick; 2 m long; slotted; according to EN 60715; "Hole width 25 mm; silver-colored	<a href="http://www.wago.com/210-112">www.wago.com/210-112</a>
	<b>Item no.: 210-114</b> Steel carrier rail; 35 x 15 mm; 1.5 mm thick; 2 m long; unslotted; similar to EN 60715; silver-colored	<a href="http://www.wago.com/210-114">www.wago.com/210-114</a>
	<b>Item no.: 210-115</b> Steel carrier rail; 35 x 7.5 mm; 1 mm thick; 2 m long; slotted; according to EN 60715; "Hole width 18 mm; silver-colored	<a href="http://www.wago.com/210-115">www.wago.com/210-115</a>
	<b>Item no.: 210-196</b> Aluminum carrier rail; 35 x 8.2 mm; 1.6 mm thick; 2 m long; unslotted; similar to EN 60715; silver-colored	<a href="http://www.wago.com/210-196">www.wago.com/210-196</a>
<b>Ferrule</b>		
Ferrule		
	<b>Item no.: 216-241</b> Ferrule; Sleeve for 0.5 mm <sup>2</sup> / 20 AWG; insulated; electro-tin plated; electrolytic copper; gastight crimped; acc. to DIN 46228, Part 4/09.90; white	<a href="http://www.wago.com/216-241">www.wago.com/216-241</a>
	<b>Item no.: 216-242</b> Ferrule; Sleeve for 0.75 mm <sup>2</sup> / 18 AWG; insulated; electro-tin plated; electrolytic copper; gastight crimped; acc. to DIN 46228, Part 4/09.90; gray	<a href="http://www.wago.com/216-242">www.wago.com/216-242</a>
	<b>Item no.: 216-243</b> Ferrule; Sleeve for 1 mm <sup>2</sup> / AWG 18; insulated; electro-tin plated; electrolytic copper; gastight crimped; acc. to DIN 46228, Part 4/09.90; red	<a href="http://www.wago.com/216-243">www.wago.com/216-243</a>
<b>Protective warning marker</b>		
Cover		
	<b>Item no.: 2000-115</b> Protective warning marker; for 5 terminal blocks; with high-voltage symbol, black; yellow	<a href="http://www.wago.com/2000-115">www.wago.com/2000-115</a>
<b>Tool</b>		
Operating tool		
	<b>Item no.: 210-648</b> Operating tool; Blade: 2.5 x 0.4 mm; with a partially insulated shaft; angled; short	<a href="http://www.wago.com/210-648">www.wago.com/210-648</a>
	<b>Item no.: 210-647</b> Operating tool; Blade: 2.5 x 0.4 mm; with a partially insulated shaft; multicoloured	<a href="http://www.wago.com/210-647">www.wago.com/210-647</a>

Subject to changes. Please also observe the further product documentation!



Item no.: 210-719

Operating tool; Blade: 2.5 x 0.4 mm; with a partially insulated shaft

## Downloads

### Documentation

#### Bid Text

2020-1301 X81 - Datei	2019 Feb 19	xml 4.2 kB	Download
--------------------------	-------------	---------------	----------

2020-1301 docx - Datei	2018 Aug 7	docx 15.5 kB	Download
---------------------------	------------	-----------------	----------

#### Additional Information

Technical Section Technical explanations		pdf 2.2 MB	Download
---	--	---------------	----------

## CAD/CAE-Data

### CAD data

2D/3D Models 2020-1301		URL	Download
------------------------	--	-----	----------

### CAE data

EPLAN Data Portal 2020-1301		URL	Download
-----------------------------	--	-----	----------

ZUKEN Portal 2020-1301		URL	Download
------------------------	--	-----	----------

WSCAD Universe 2020-1301		URL	Download
--------------------------	--	-----	----------

## Environmental Product Compliance

### Compliance Search

Environmental Product Compliance 2020-1301 2-conductor/1-pin carrier terminal block; for DIN-rail 35 x 15 and 35 x 7.5; Push-in CAGE CLAMP®; 1,00 mm²; gray		URL	Download
--	--	-----	----------

Subject to changes. Please also observe the further product documentation!

## Installation Notes

### Installation

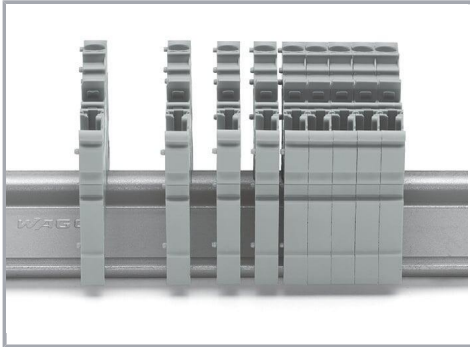

Snap individual carrier terminal blocks onto the DIN-rail and slide together.

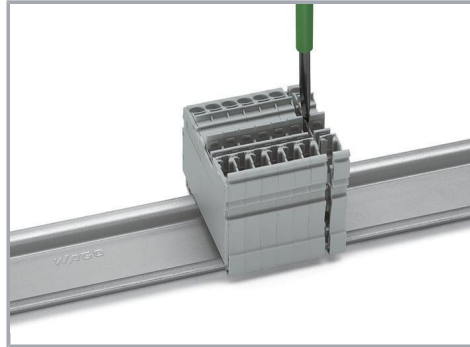

Open the assembly by laterally sliding a block via operating tool (3.5 x 0.5 mm blade).

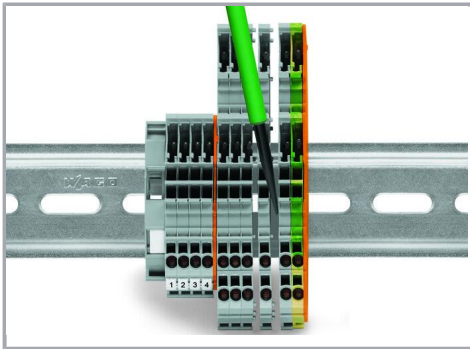

Separate terminal block assembly and slide individual terminal blocks laterally using an operating tool.

### Conductor termination

Subject to changes. Please also observe the further product documentation!

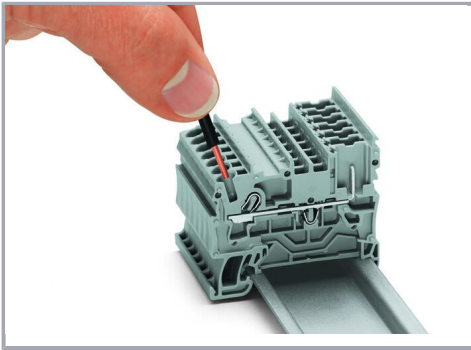

Push-in CAGE CLAMP® enables solid conductors to be connected by simply pushing them into the unit.

### Commoning

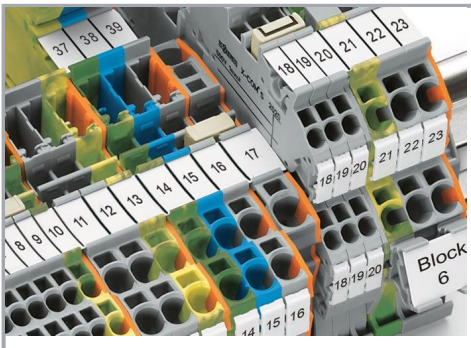

Commoning X-COM®S-SYSTEM Terminal Blocks using jumpers for TOPJOB® S Terminal Blocks. An end plate provides connection to TOPJOB® S Terminal Blocks. 2020 and 2022 Series Terminal Blocks are combinable. Jumper slots are on the same level for both series.

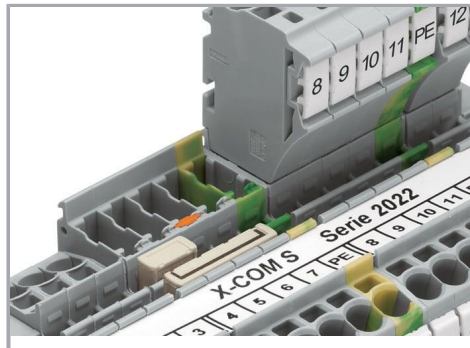

Pairing push-in comb style jumpers.

Subject to changes. Please also observe the further product documentation!

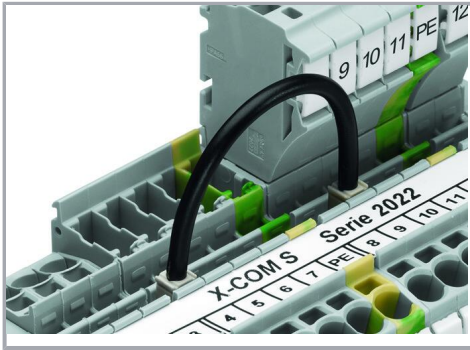

Commoning with push-in type wire jumper.

### Testing

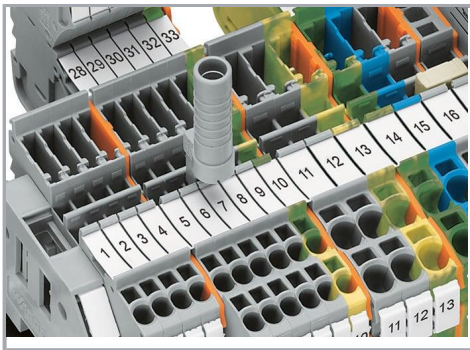

Test plug adapter (2009-174) for 4 mm test plugs or banana plugs – also suitable for X-COM®S-SYSTEM-MINI Terminal Blocks.

### Coding

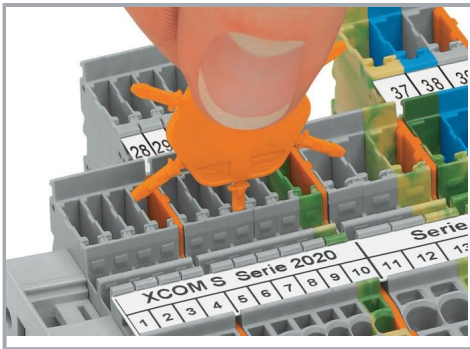

Insert coding pin into the corresponding slot and twist it off.

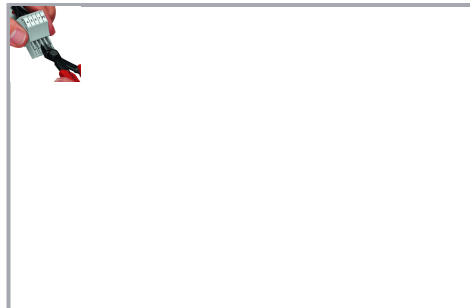

Coding a female plug: remove coding finger using a suitable tool.

Subject to changes. Please also observe the further product documentation!





Insert a coding pin (2022-100) into the corresponding location of the carrier terminal block.

### Marking

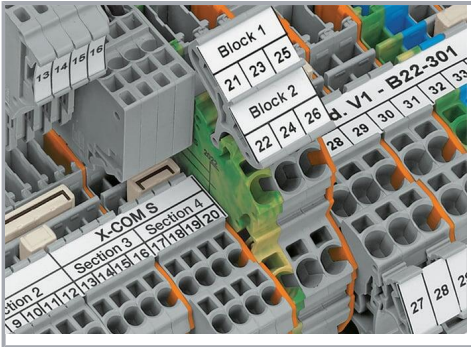

Clear marking via large marking area

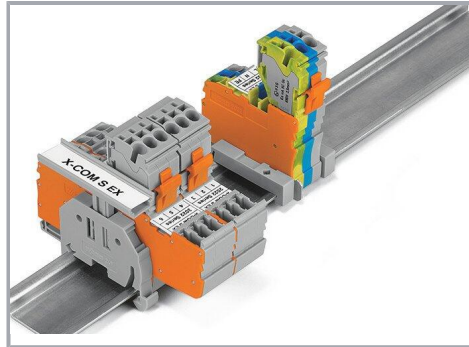

Group marking with height-adjustable group marker carrier (2009-163)

### Security

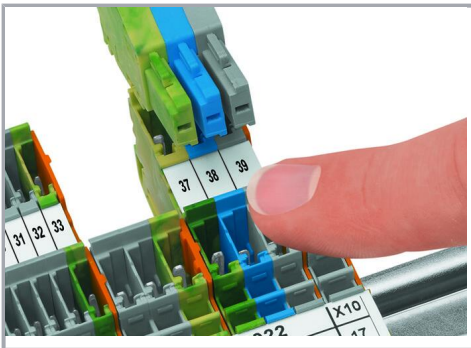

Carrier terminal blocks and female plugs are touch-proof.

### Product family

Subject to changes. Please also observe the further product documentation!



**X-COM S-Mini**

[Show all products from the family](#)

Subject to changes. Please also observe the further product documentation!

---

WAGO GmbH & Co. KG  
Hansastr. 27  
32423 Minden  
Phone: +49571 887-0 | Fax: +49571 887-169  
Email: [info.de@wago.com](mailto:info.de@wago.com) | Web: [www.wago.com](http://www.wago.com)

Do you have any questions about our products?  
We are always happy to take your call at +49 (571) 887-44222.