

P/N : 46562-9330 (G-5P-30S-5P-G)

ALLOW EXTRA SPACE
4.00 MM PER SIDE
(REQUIRED FOR RE-WORK PER AS-46436-100)

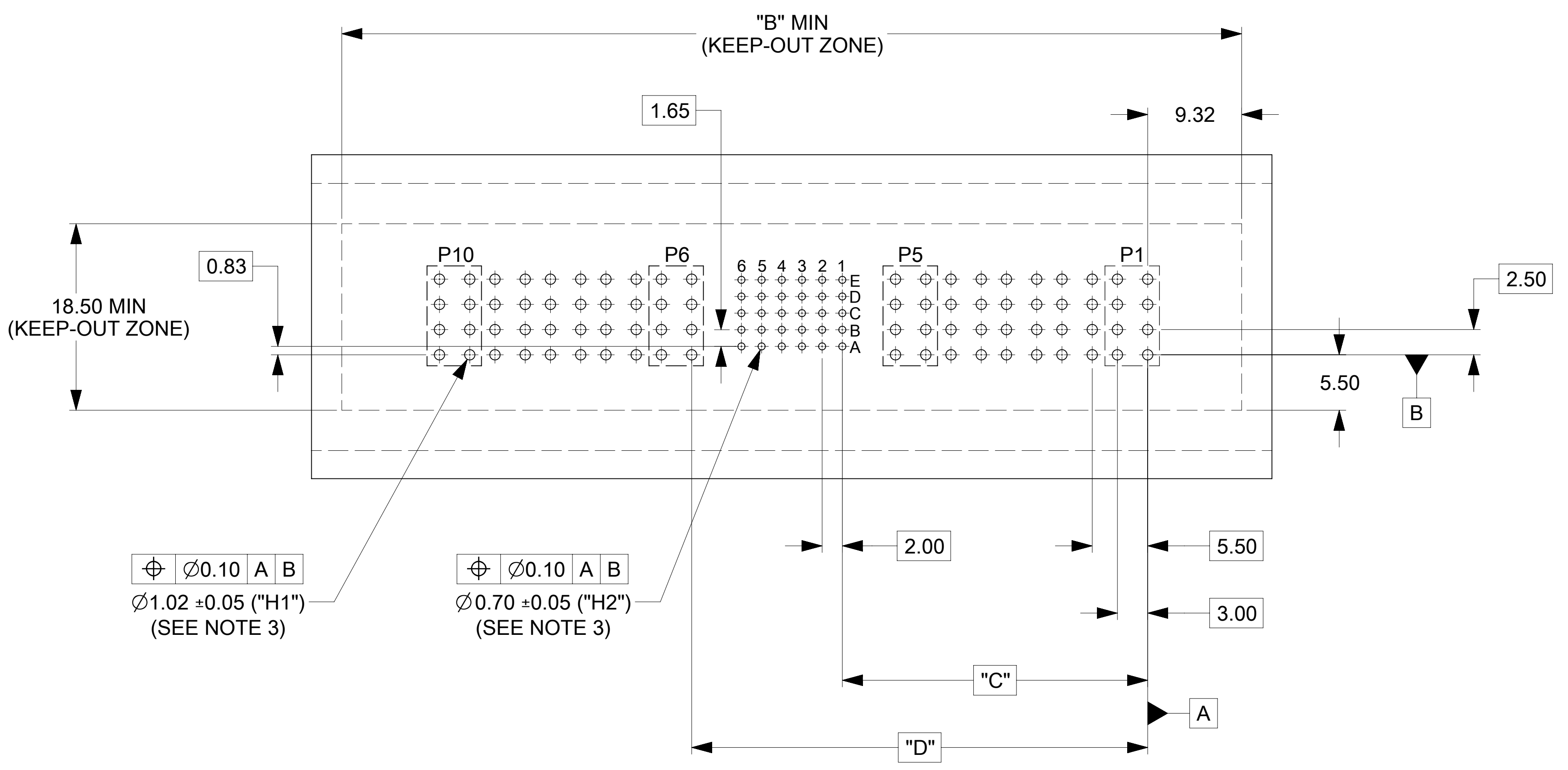
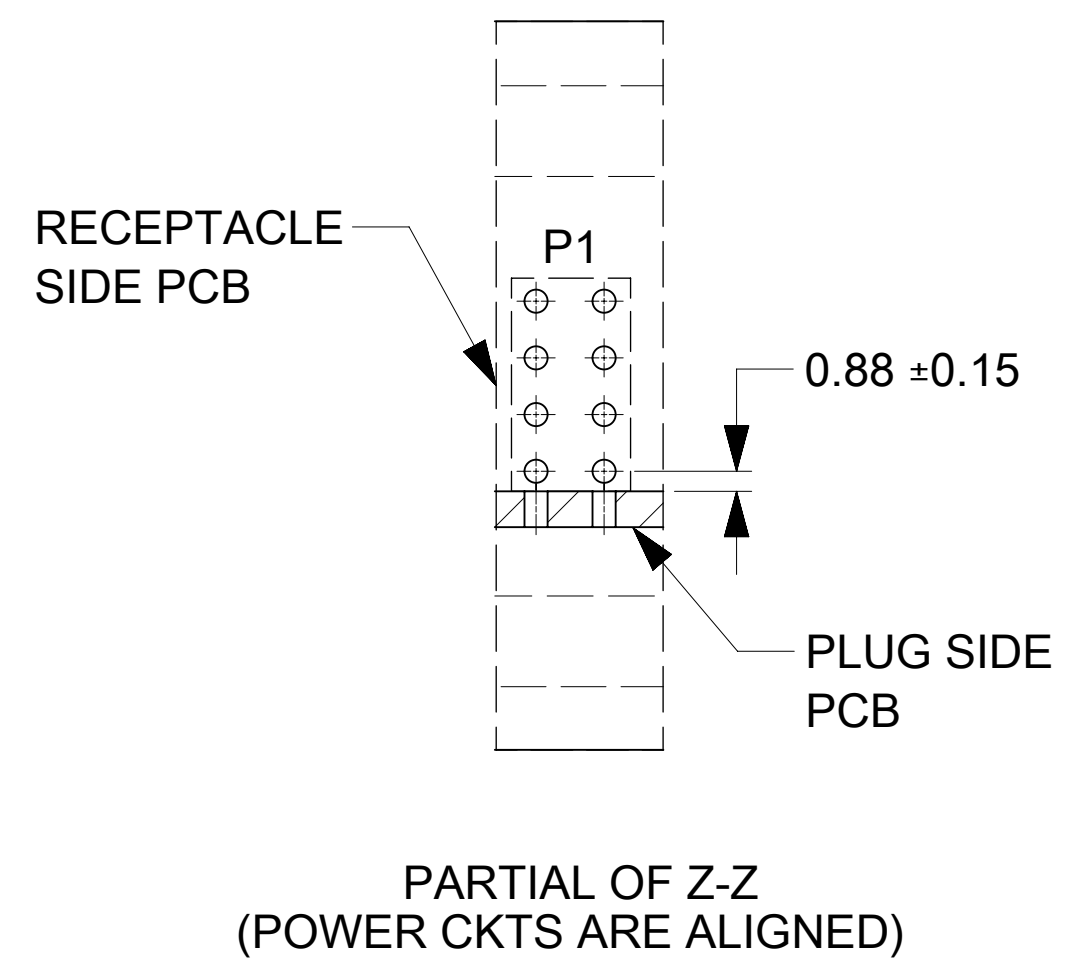
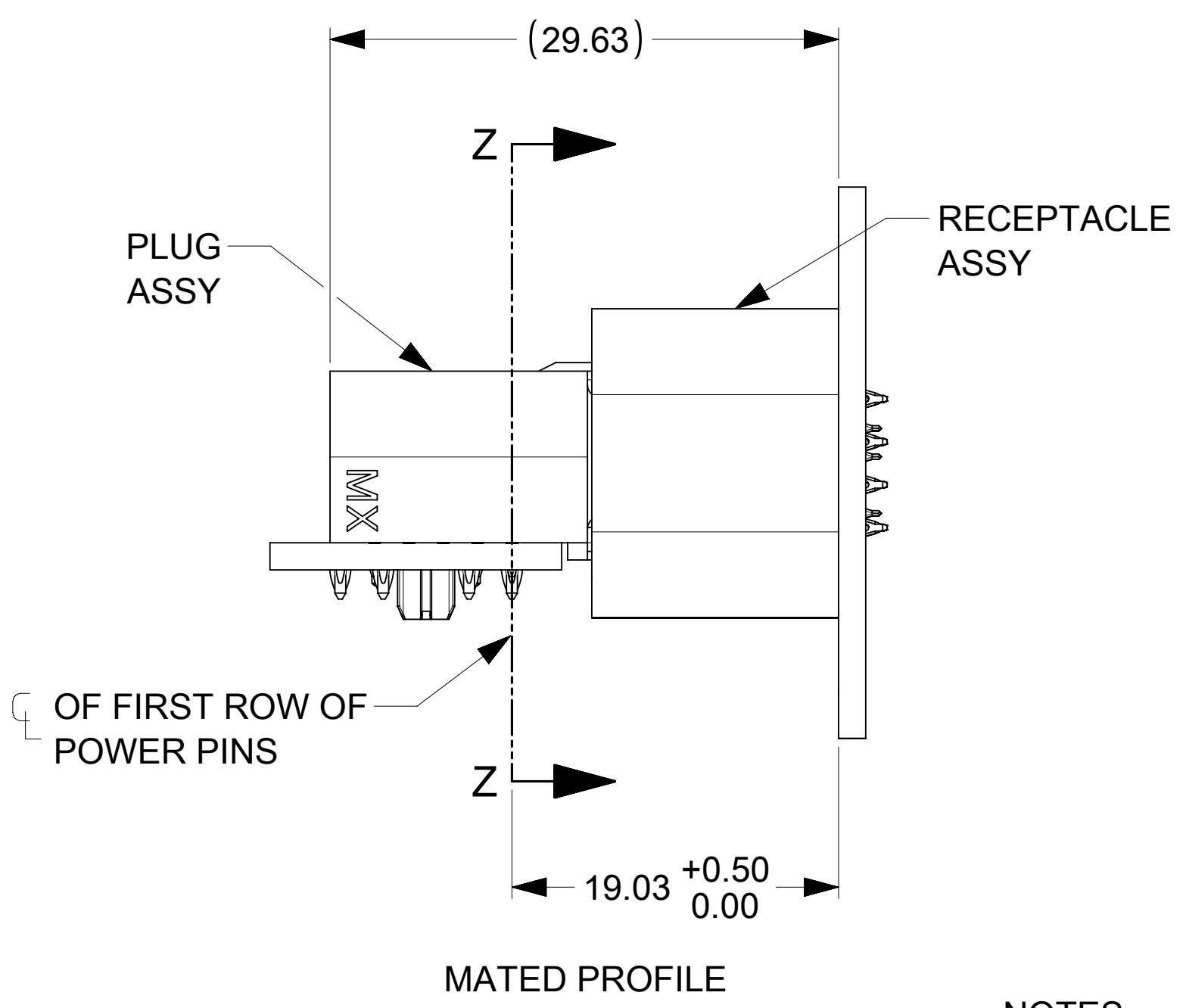
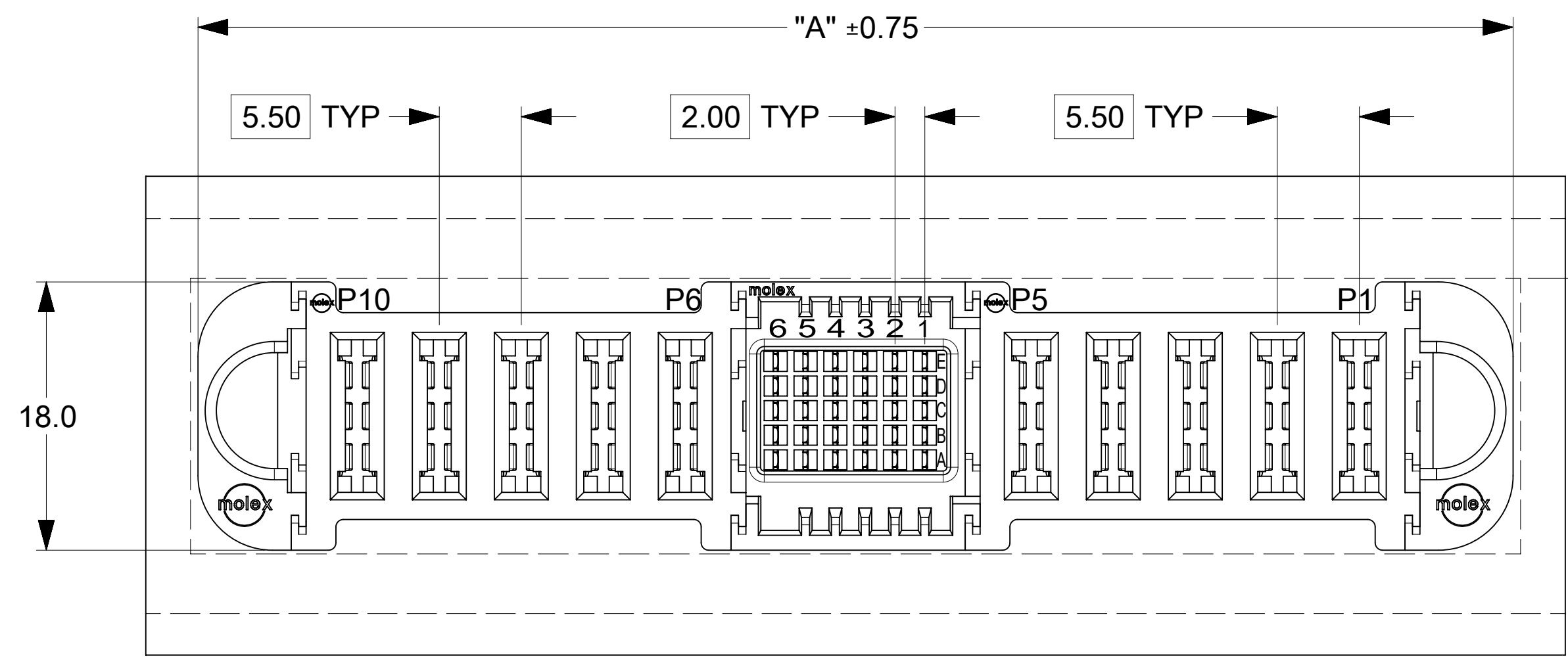

- NOTES:
- MATERIAL:
 - HOUSINGS: LCP UL94, V-0, COLOR: BLACK
 - TERMINALS: HIGH CONDUCTIVITY COPPER ALLOY
 - PLATING: 1.27 MICROMETER (50 MICROINCH) NICKEL OVERALL WITH 2.54 MICROMETER (100 MICROINCH) SELECTIVE TIN ON TAILS AND 0.762 MICROMETER (30 MICROINCH) SELECTIVE GOLD ON CONTACT AREA
 - PACKAGING: ASSEMBLIES TO BE TRAY PACKED PER PACKAGING SPEC: 465621001-PK
 - PLATED THRU HOLE SIZE, REFER TO PS-46436-100 FOR DETAILS
 - PRODUCT SPEC: PS-46436-100
 - APPLICATION SPEC: AS-46436-100
 - PRODUCT TO MEET RoHS REQUIREMENTS
 - ASSEMBLY MATES TO MOLEX PLUG ASSEMBLY P/N 46437-**** (SEE TABLE IN SHEET 2)
 - TAIL DESIGN: COMPLIANT PINS
 - POWER AND SIGNAL CONTACTS ARE LUBRICATED.
 - MOLEX LOGO TO BE LOCATED APPROXIMATELY AS SHOWN.

THIS DRAWING CONTAINS INFORMATION THAT IS PROPRIETARY TO MOLEX ELECTRONIC TECHNOLOGIES, LLC AND SHOULD NOT BE USED WITHOUT WRITTEN PERMISSION									
DIMENSION UNITS	SCALE	CURRENT REV DESC: ADDED ISOMETRIC VIEWS							
mm	3:1								
GENERAL TOLERANCES (UNLESS SPECIFIED)									
ANGULAR TOL	± 0.5°								
4 PLACES	±	EC NO: 689821							
3 PLACES	±	DRWN: HARSHG		2021/12/13					
2 PLACES	± 0.13	CHK'D: GJEEVANSURES		2021/12/22					
1 PLACE	± 0.25	APPR: HTHYAGARAJ		2022/02/14					
0 PLACES	±	INITIAL REVISION:							
DRAFT WHERE APPLICABLE MUST REMAIN WITHIN DIMENSIONS		DRWING		SERIES					
		D-SIZE		46562		MATERIAL NUMBER		CUSTOMER	
				SEE TABLE		GENERAL MARKET		SHEET NUMBER	
								1 OF 4	

RECOMMENDED PCB LAYOUT AND KEEP-OUT ZONE FOR G-(1P TO 5P)-30S-(1P TO 5P)-G

DOCUMENT STATUS	P1	RELEASE DATE	2022/02/14	09:02:13
-----------------	----	--------------	------------	----------

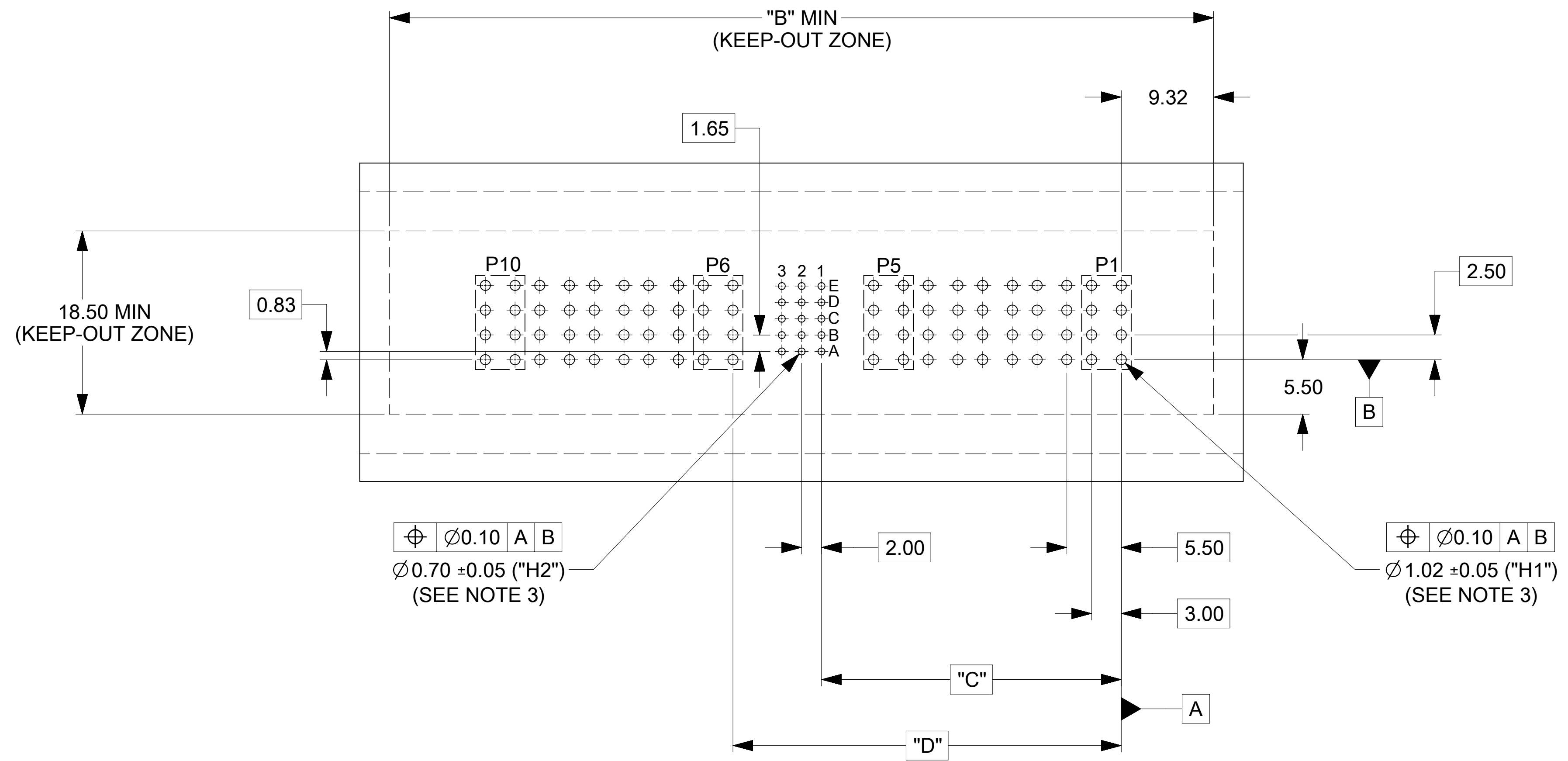

RECOMMENDED PCB LAYOUT AND KEEP-OUT ZONE FOR G-(1P TO 5P)-15S-(1P TO 5P)-G

REFER TO BELOW TABLE FOR DIMENSIONS.

FG P/N	CONFIGURATION	POWER CKT SIZE	SIGNAL CKT SIZE	DIM "A" (IN MM)	DIM "B" (IN MM)	DIM "C" (IN MM)	DIM "D" (IN MM)	HOLES COUNT "H1"	HOLES COUNT "H2"	MATES WITH R/A PLUG ASSY P/N
465629321	G-1P-15S-1P-G	1	15	38.21	39.21	8.28	17.21	16	15	464379321
465629322	G-2P-15S-2P-G	2	15	49.21	50.21	13.78	22.71	32	15	464379322
465629323	G-3P-15S-3P-G	3	15	60.21	61.21	19.28	28.21	48	15	464379323
465629324	G-4P-15S-4P-G	4	15	71.21	72.21	24.78	33.71	64	15	464379324
465629325	G-5P-15S-5P-G	5	15	82.21	83.21	30.28	39.21	80	15	464379325
465629326	G-1P-30S-1P-G	1	30	44.21	45.21	8.28	23.21	16	30	464379326
465629327	G-2P-30S-2P-G	2	30	55.21	56.21	13.78	28.71	32	30	464379327
465629328	G-3P-30S-3P-G	3	30	66.21	67.21	19.28	34.21	48	30	464379328
465629329	G-4P-30S-4P-G	4	30	77.21	78.21	24.78	39.71	64	30	464379329
465629330	G-5P-30S-5P-G	5	30	88.21	89.21	30.28	45.21	80	30	464379330

THIS DRAWING CONTAINS INFORMATION THAT IS PROPRIETARY TO MOLEX ELECTRONIC TECHNOLOGIES, LLC AND SHOULD NOT BE USED WITHOUT WRITTEN PERMISSION

DIMENSION UNITS	SCALE	CURRENT REV DESC: ADDED ISOMETRIC VIEWS	
mm	3:1		
GENERAL TOLERANCES (UNLESS SPECIFIED)			
ANGULAR TOL	± 0.5°		
4 PLACES	±	EC NO: 689821	
3 PLACES	±	DRWN: HARSHG	2021/12/13
2 PLACES	± 0.13	CHK'D: GJEEVANSURES	2021/12/22
1 PLACE	± 0.25	APPR: HTHYAGARAJ	2022/02/14
0 PLACES	±	INITIAL REVISION:	
DRAFT WHERE APPLICABLE MUST REMAIN WITHIN DIMENSIONS		DRWN: KSUTAR	2021/08/17
THIRD ANGLE PROJECTION		APPR: HTHYAGARAJ	2021/10/21
DRAWING		SERIES	
D-SIZE		46562	
MATERIAL NUMBER		CUSTOMER	SHEET NUMBER
SEE TABLE		GENERAL MARKET	2 OF 4

molex

G-*P-*S-*P-G
VERT RECEPTACLE ASSY - TEN60 POWER FAMILY

PRODUCT CUSTOMER DRAWING

DOCUMENT NUMBER: 465629330 | DOC TYPE: PSD | DOC PART: 000 | REVISION: A1

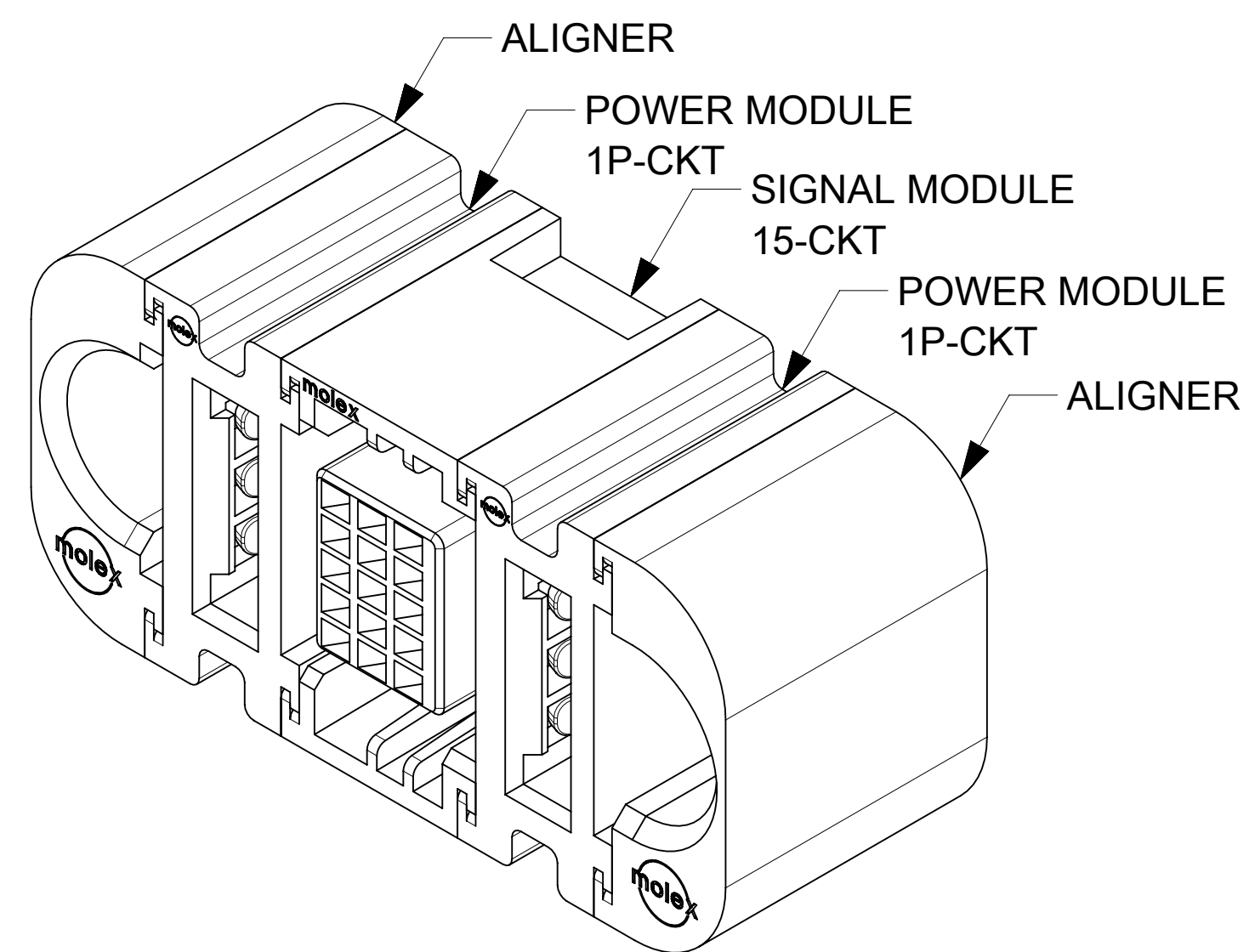

P/N : 46562-9321 (G-1P-15S-1P-G)

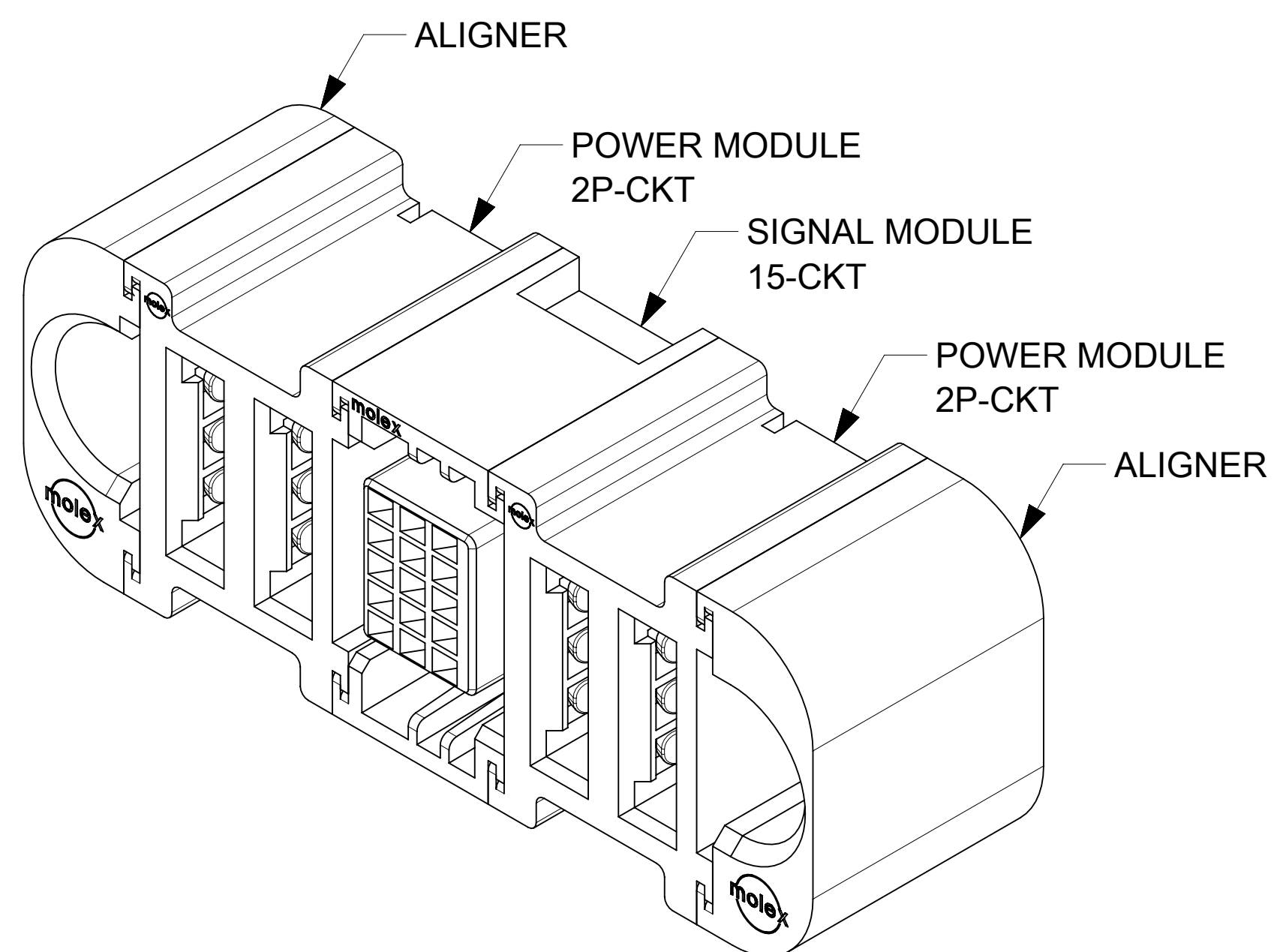

P/N : 46562-9322 (G-2P-15S-2P-G)

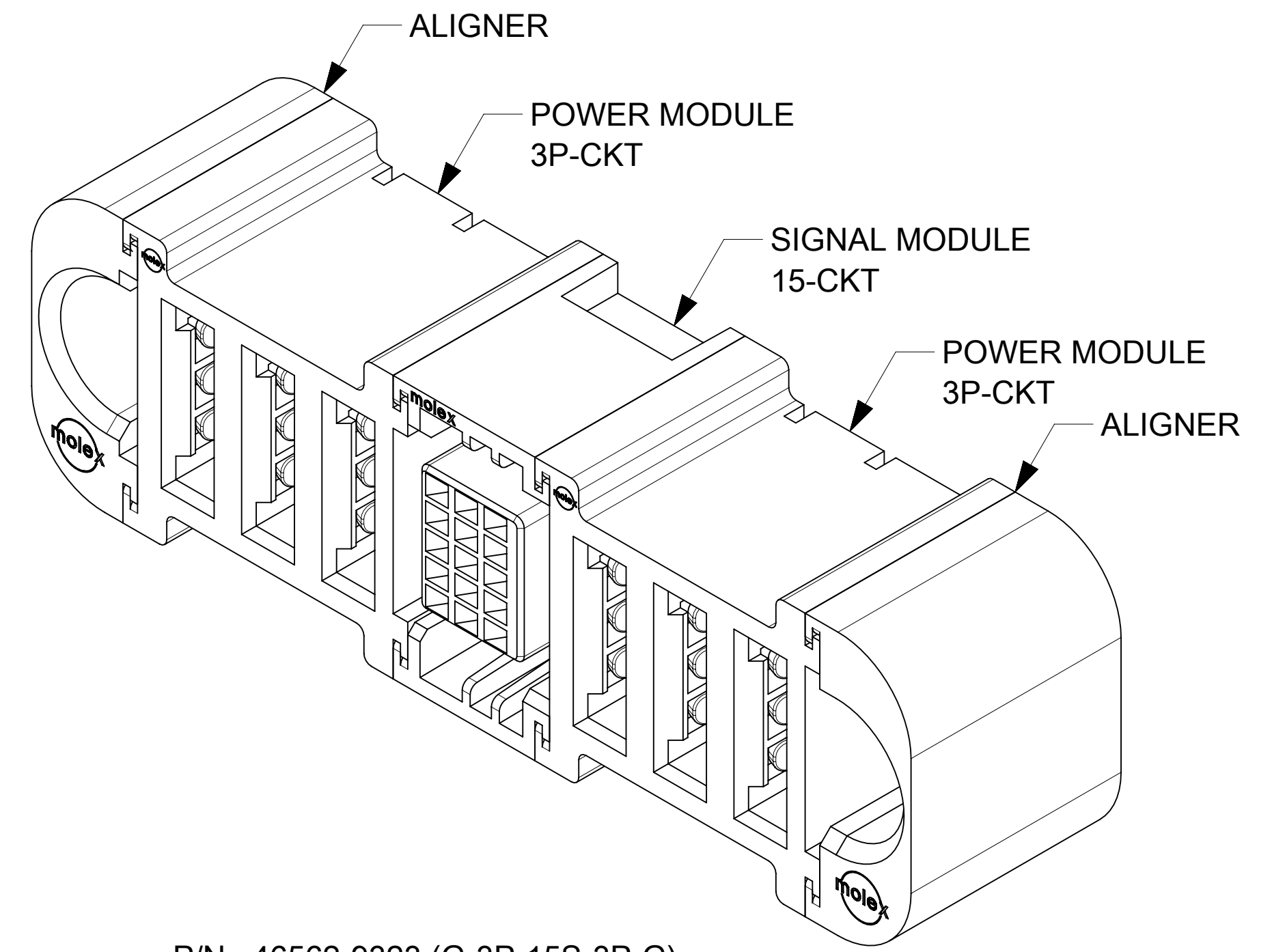

P/N : 46562-9323 (G-3P-15S-3P-G)

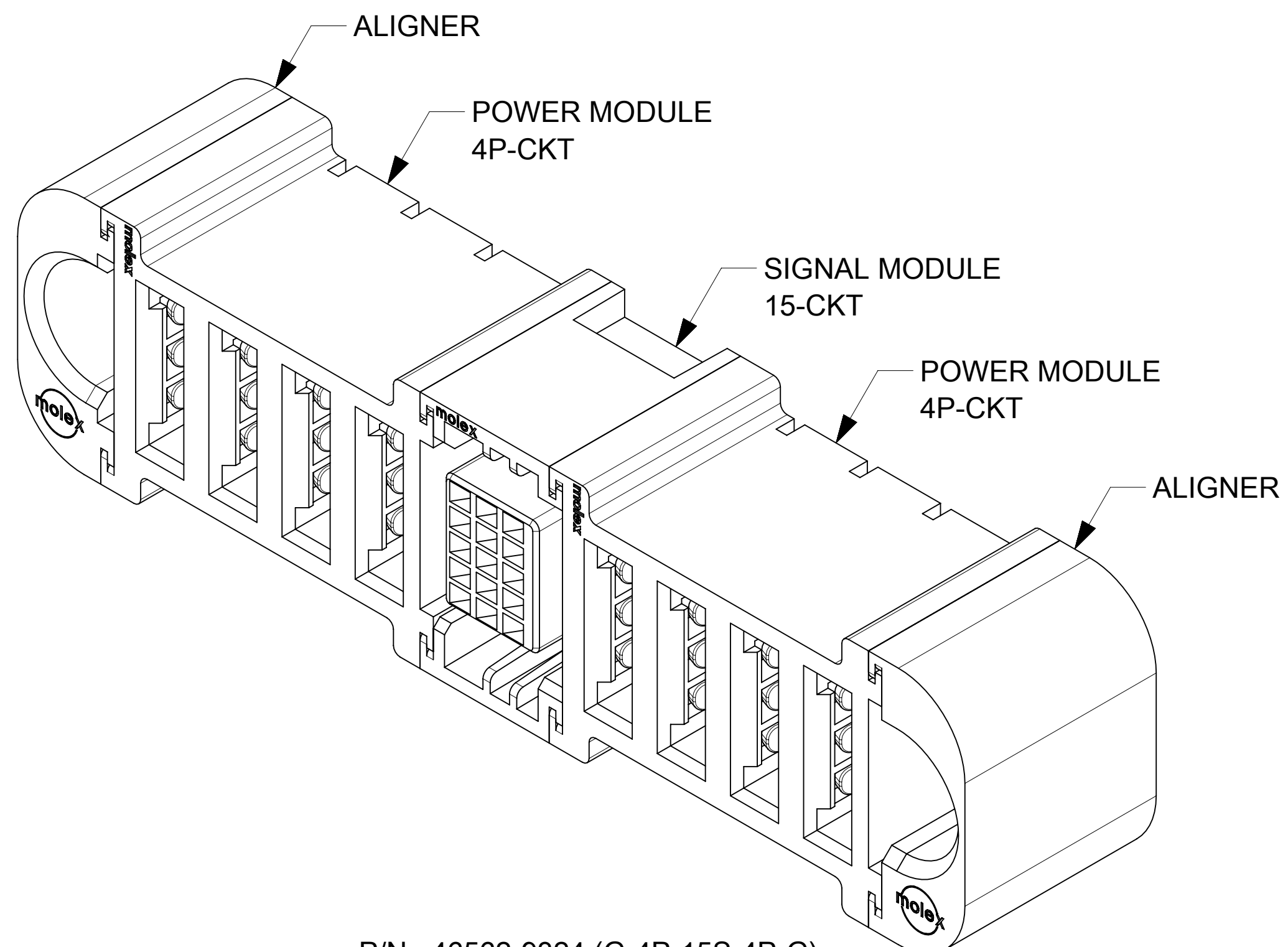

P/N : 46562-9324 (G-4P-15S-4P-G)

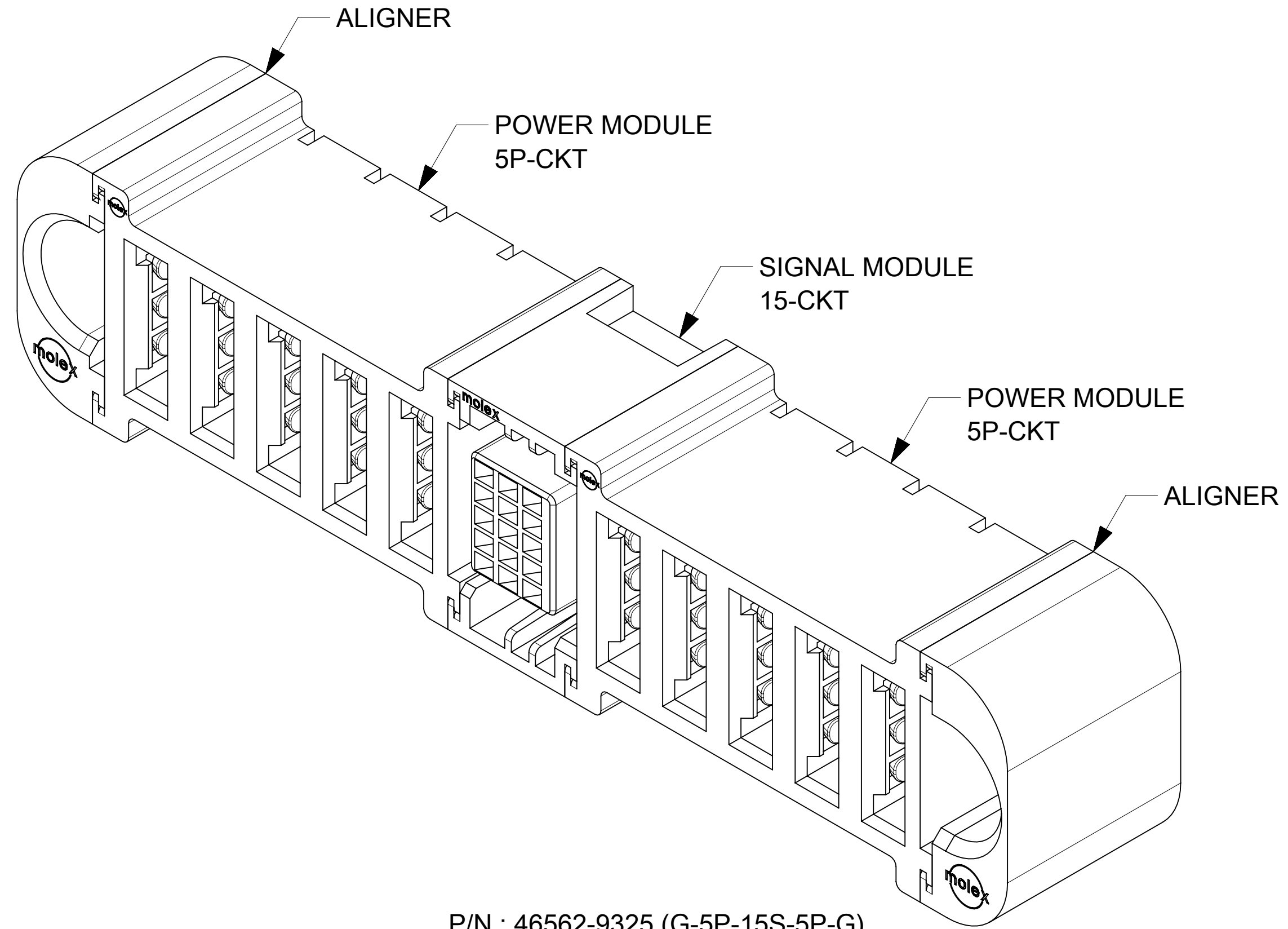

P/N : 46562-9325 (G-5P-15S-5P-G)

THIS DRAWING CONTAINS INFORMATION THAT IS PROPRIETARY TO MOLEX ELECTRONIC TECHNOLOGIES, LLC AND SHOULD NOT BE USED WITHOUT WRITTEN PERMISSION									
DIMENSION UNITS		SCALE		CURRENT REV DESC: ADDED ISOMETRIC VIEWS					
mm		4:1							
GENERAL TOLERANCES (UNLESS SPECIFIED)									
ANGULAR TOL ± 0.5°									
4 PLACES		±		EC NO: 689821					
3 PLACES		±		DRWN: HARSHG 2021/12/13					
2 PLACES		± 0.13		CHK'D: GJEEVANSURES 2021/12/22					
1 PLACE		± 0.25		APPR: HTHYAGARAJ 2022/02/14					
0 PLACES		±		INITIAL REVISION:					
				DRWN: KSUTAR 2021/08/17					
				APPR: HTHYAGARAJ 2021/10/21					
DRAFT WHERE APPLICABLE MUST REMAIN WITHIN DIMENSIONS				THIRD ANGLE PROJECTION		DRAWING		SERIES	
				D-SIZE		46562			
				MATERIAL NUMBER		CUSTOMER		SHEET NUMBER	
				SEE TABLE		GENERAL MARKET		3 OF 4	

molex

G-*P-*S-*P-G
VERT RECEPTACLE ASSY - TEN60 POWER FAMILY

PRODUCT CUSTOMER DRAWING

DOCUMENT NUMBER	DOC TYPE	DOC PART	REVISION
465629330	PSD	000	A1

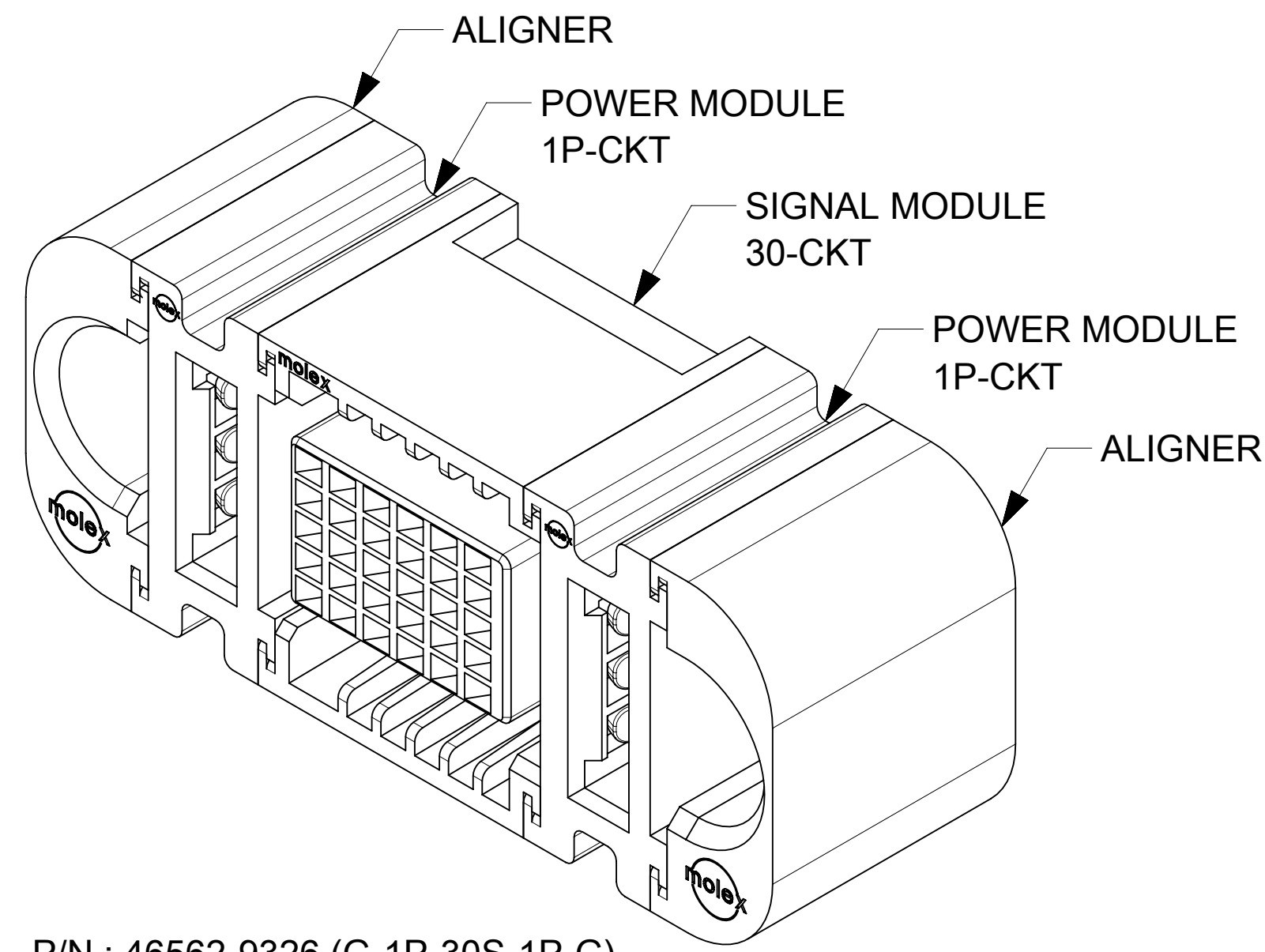

P/N : 46562-9326 (G-1P-30S-1P-G)

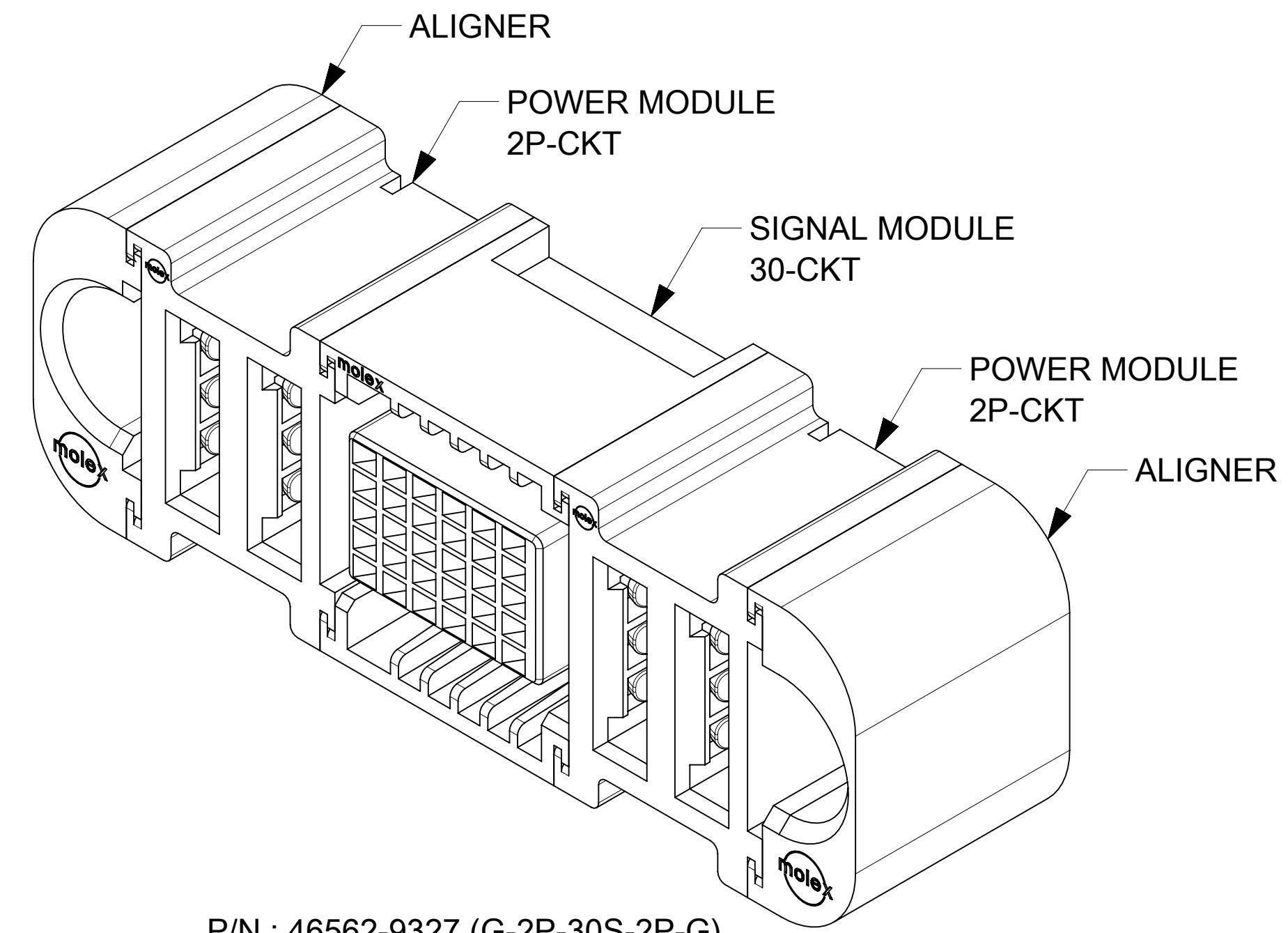

P/N : 46562-9327 (G-2P-30S-2P-G)

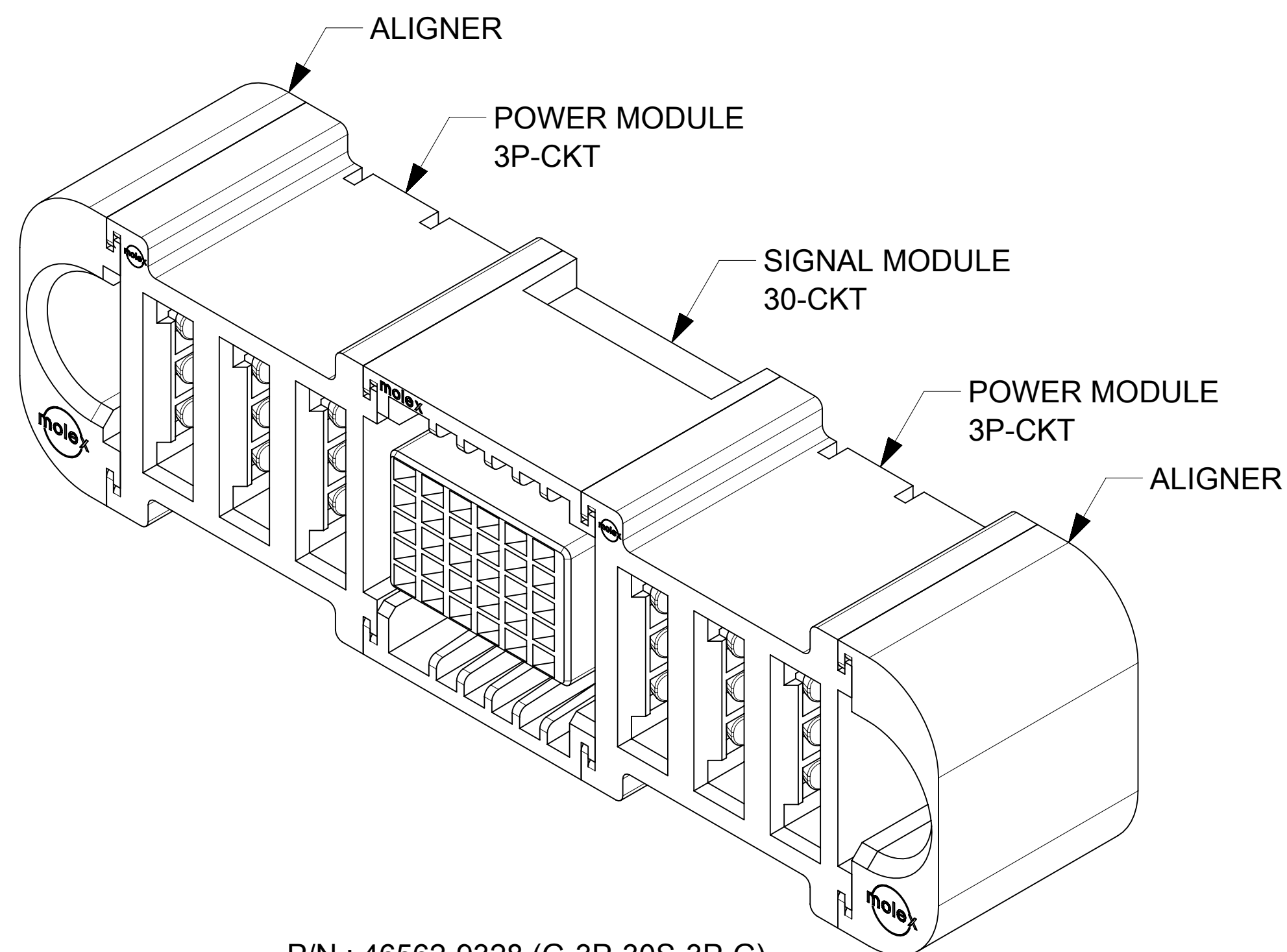

P/N : 46562-9328 (G-3P-30S-3P-G)

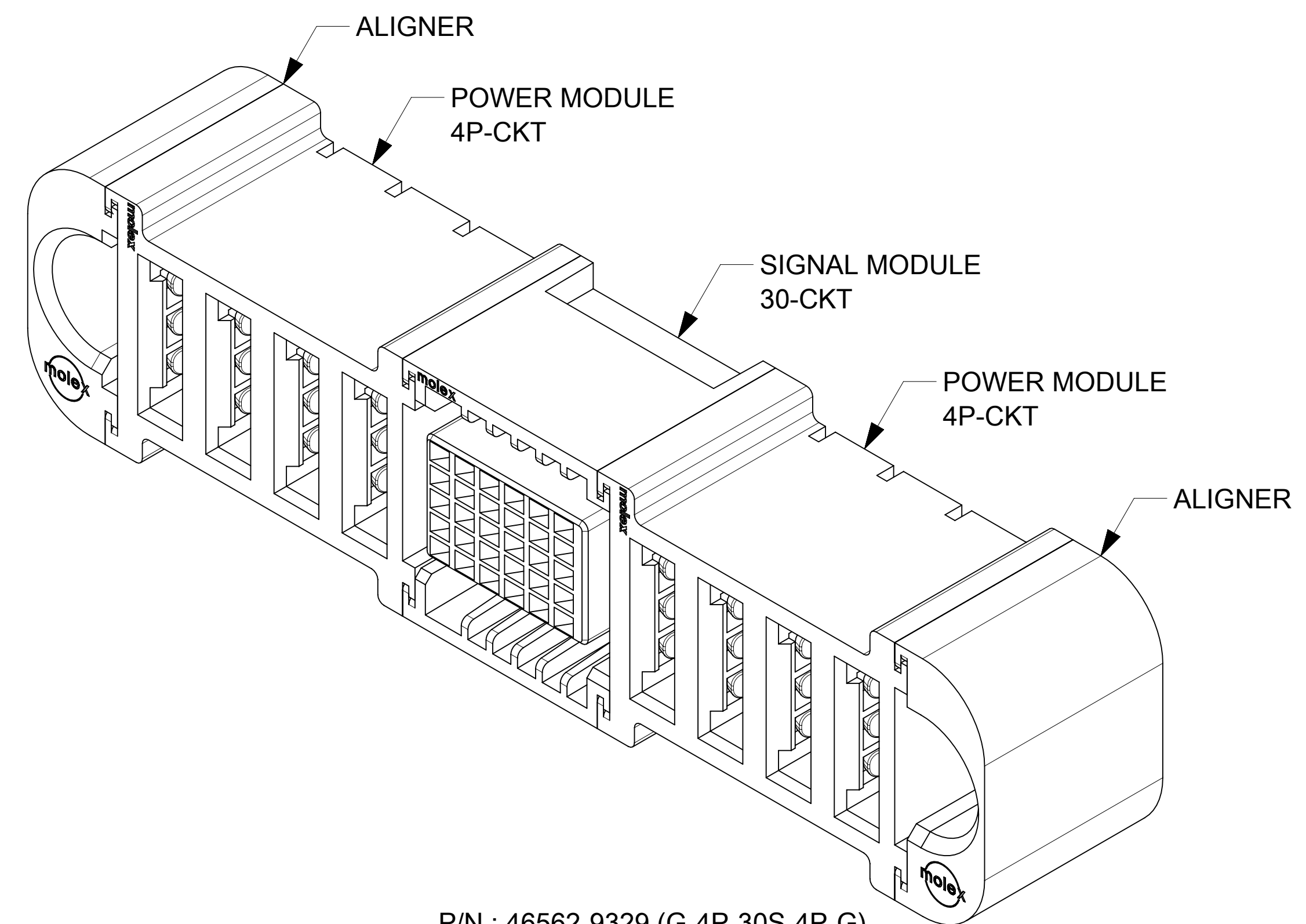

P/N : 46562-9329 (G-4P-30S-4P-G)

THIS DRAWING CONTAINS INFORMATION THAT IS PROPRIETARY TO MOLEX ELECTRONIC TECHNOLOGIES, LLC AND SHOULD NOT BE USED WITHOUT WRITTEN PERMISSION									
DIMENSION UNITS		SCALE		CURRENT REV DESC: ADDED ISOMETRIC VIEWS					
mm		4:1							
GENERAL TOLERANCES (UNLESS SPECIFIED)									
ANGULAR TOL		± 0.5°							
4 PLACES		±		EC NO: 689821					
3 PLACES		±		DRWN: HARSHG		2021/12/13			
2 PLACES		± 0.13		CHK'D: GJEEVANSURES		2021/12/22			
1 PLACE		± 0.25		APPR: HTHYAGARAJ		2022/02/14			
0 PLACES		±		INITIAL REVISION:					
DRAFT WHERE APPLICABLE		THIRD ANGLE PROJECTION		DRWN: KSUTAR		2021/08/17			
MUST REMAIN WITHIN DIMENSIONS		DRAWING		APPR: HTHYAGARAJ		2021/10/21			
		D-SIZE		SERIES					
		46562		MATERIAL NUMBER		CUSTOMER			
		SEE TABLE		GENERAL MARKET		SHEET NUMBER			
		4 OF 4							

molex

G-*P-*S-*P-G
VERT RECEPTACLE ASSY - TEN60 POWER FAMILY

PRODUCT CUSTOMER DRAWING

DOCUMENT NUMBER DOC TYPE DOC PART REVISION

465629330

PSD 000 A1

MATERIAL NUMBER CUSTOMER SHEET NUMBER

SEE TABLE GENERAL MARKET 4 OF 4