



# SUNON

## SPECIFICATION FOR APPROVAL

**CUSTOMER** : Sunon Inc.

**MOTOR TYPE** : 

**DESCRIPTION** : MagLev Motor Fan

**DIMENSIONS** : 12X12X3 mm

**MODEL** : UF3C3-500

**SUNON SPEC. NO.** : D01001051F-02

**CUSTOMER APPROVAL NO.** : UF3C3-500 TC

**APPROVED BY CUSTOMER** :

(AUTHORIZED)

|       |                          |         |           |          |           |               |               |
|-------|--------------------------|---------|-----------|----------|-----------|---------------|---------------|
| DRAWN | Alice-<br>chang<br>10/17 | CHECKED | Chin-jung | APPROVED | Chin-jung | SPEC.NO       | D01001051F-02 |
|       |                          |         |           |          |           | ISSUE DATE    | 10.17.2018    |
|       |                          |         |           |          |           | EDITION       | 0             |
|       |                          |         |           |          |           | REVISION DATE |               |
|       |                          |         |           |          |           | E.SPEC        | E30900399     |

建準電機工業股份有限公司

SUNONWEALTH ELECTRIC MACHINE INDUSTRY CO., LTD.

NO. 30, LN. 296, XINYA RD., QIANZHEN DIST.,  
KAOHSIUNG CITY 80673, TAIWAN (R.O.C)

URL:<http://www.sunon.com>

TEL:886-7-8135888

FAX:886-7-8230505/8230606/8231010

E-mail: [sunon@email.sunon.com.tw](mailto:sunon@email.sunon.com.tw)

## DC BRUSHLESS FAN

### MODEL : UF3C3-500

#### CHARACTERISTICS

- |  |  |
|--|--|
| <b>1. Motor Design</b>                     | : Single phase, 6-poles Brushless DC motor.  |
| <b>2. Insulation Resistance</b>            | : More than 20M ohm between internal stator and lead wire(+) measured at DC 100V.  |
| <b>3. Dielectric Strength</b>              | : Applied AC 500V for one minute or AC 600V for 2 seconds between housing and lead wire(+)   |
| <b>4. Noise Level</b>                      | : Measured in a semi-anechoic chamber with background noise level below 15 dB(A). The fan is running in free air with the microphone at a distance of 20 centimeter from the fan intake. |
| <b>5. Input Power, Current &amp; Speed</b> | : Measured after continuous 10 minute operation at rated voltage in clean air, and at ambient temperature of 25 degrees C.   |
| <b>6. Tolerance</b>                        | : +15% / -30% on rated power and current.  |
| <b>7. Air Performance</b>                  | : Measured by a double chamber. The values are recorded when the fan speed has stabilized at rated voltage.  |

|  |            |               |               |   |
|--|------------|---------------|---------------|---|
| 建準電機工業股份有限公司<br>SUNONWEALTH ELECTRIC<br>MACHINE INDUSTRY CO., LTD. | SPEC.NO    | D01001051F-02 | REVISION DATE |   |
|  | ISSUE DATE | 10.17.2018    | E D I T I O N | 0 |
|  | P A G E    | 2 O F 12      |               |   |

**SPECIFICATIONS**

**MODEL : UF3C3-500**

- 1-1. Rated Voltage : 3 VDC**
- 1-2. Operating Voltage Range : 2.0~3.5 VDC**
- 1-3. Starting Voltage : 2.0 VDC (25 deg. C POWER ON/OFF)**
- 1-4. Rated Speed : 16500 RPM ± 30%**
- 1-5. Air Delivery : 5.95 l/min**
- 1-6. Static Pressure : 18.91 Pa**
- 1-7. Rated Current : 97 mA**
- 1-8. Rated Power : 0.3 WATTS**
- 1-9. Noise Level : 14.0 dB(A) @ 1M  
28.3 dB(A) @ 0.2M**
- 1-10. Direction of Rotation : Counter-clockwise viewed from front of fan blade**
- 1-11. Operating Temperature : -10 to +70 deg. C**
- 1-12. Storage Temperature : -40 to +70 deg. C**
- 1-13. Bearing System : Vapo bearing system**
- 1-14. Weight : 0.7 g**
- 1-15. Safety : CE Approvals**
- 1-16. Protection : Automatic Restart Capability**  
 Note: In a situation where the fan is locked by an external force while the electricity is on, an increase in coil temperature will be prevented by temporarily turning off the electrical power to the motor. The fan will automatically restart when the locked rotor condition is released.  
Polarity Protection
- 1-17. IP Class : IP55** : According to IEC 60529 (or IEC 34-5) IP standard, the average temperature is 23~24°C and humidity is 67% RH for Dust Water Test. The fan needs to be test and Spray Put in dust box for 8 hours for Dust Test and be sprayed low pressure jets of water from all directions for Spray Water Test. After these 2 tests, which executing by regular standard, the fan will be measured the performance is normal or not.  
 PS. There are different applicative environments and systems by different customers, so please put the product in the most suitable environment to measure the performances.

|  |                   |                      |                      |          |
|--|-------------------|----------------------|----------------------|----------|
| 建準電機工業股份有限公司<br>SUNONWEALTH ELECTRIC<br>MACHINE INDUSTRY CO., LTD. | <b>SPEC.NO</b>    | <b>D01001051F-02</b> | <b>REVISION DATE</b> |          |
|  | <b>ISSUE DATE</b> | <b>10.17.2018</b>    | <b>E D I T I O N</b> | <b>0</b> |
|  | <b>P A G E</b>    | <b>3 O F 12</b>      |                      |          |

# MODEL : UF3C3-500

## PERFORMANCE CURVES

### STATIC PRESSURE

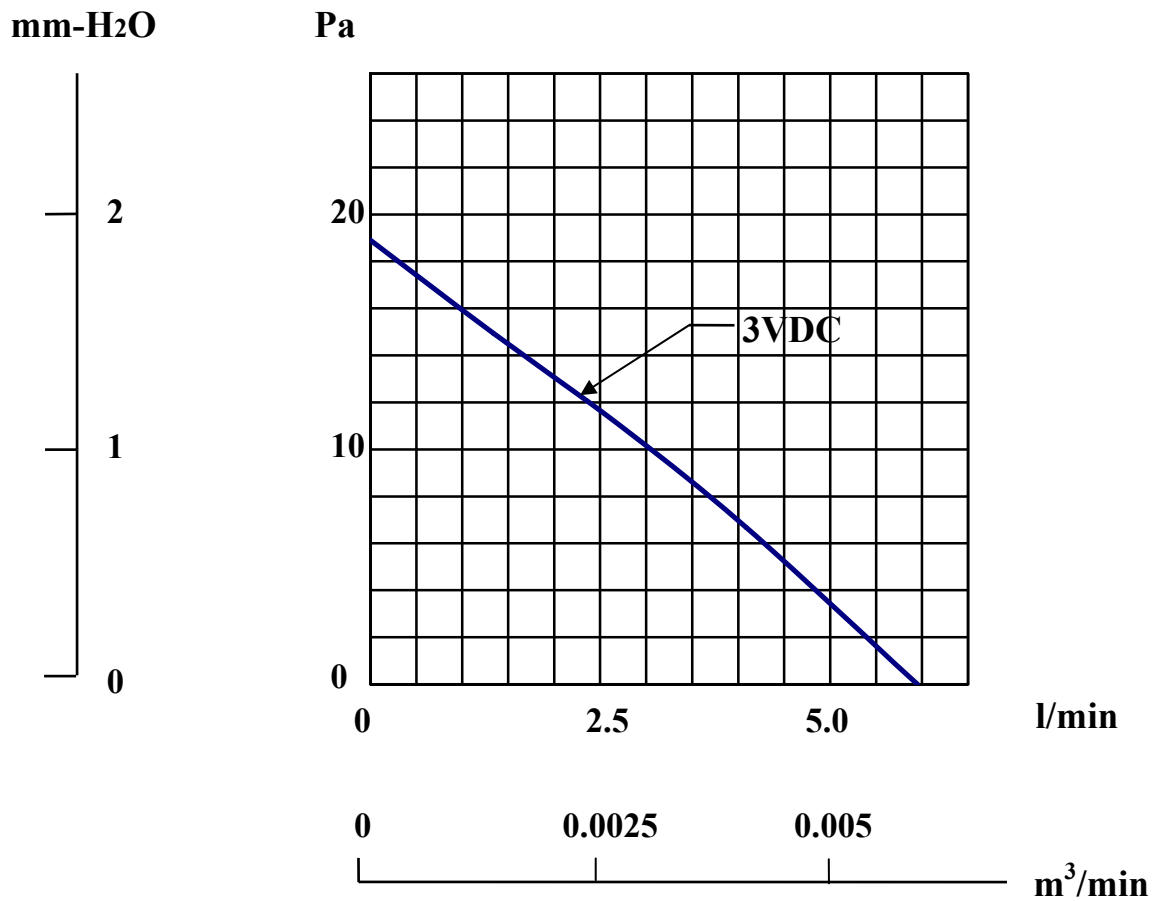

## MATERIAL

- 2-1. Frame : Thermoplastic LCP of UL 94V-0
- 2-2. Impeller : Thermoplastic LCP of UL 94V-0
- 2-3. Lead Wire : UL10064,32 awg,+RED,-BLACK  
UL10064,32 awg,YELLOW:3rd Wire

## DIMENSIONS

**Note: SUNON recommends the screw and torque as below. Please contact SUNON, if any new requirement is requested.**

| Screw Type<br>(Pan head) | Torque         | Screw Spec |                |
|--------------------------|----------------|------------|----------------|
| Machine screw            | 0.3~0.5 Kgf-cm | Size       | Standard       |
|                          |                | M1.4       | JIS B1111-1974 |

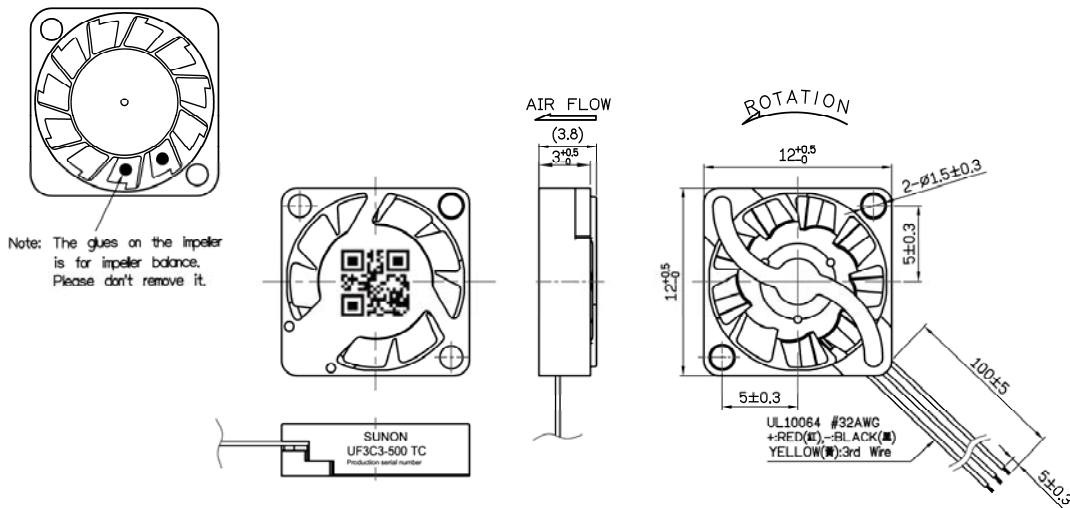

Marking (By laser):  
 SUNON  
 UF3C3-500 TC:Model name  
 Production serial number:0Y17xxxxxx  
 0:Printing Plant Code  
 Y:Manufacture Plant  
 17:Year,2017=17  
 xxxxxx: Producing Lot No.  
 QR code :Content according to  
 SUNON QR code specification  
 TC:CUSTOMER NUMBER

Sunon standard sample exclude the connector. If there is any request for connector, please advise in advance.  
 About recommend connector, SUNON recommend the following models for SUNON Mighty Mini Fan/Blower:  
 1.(JST) SUR series connector: 02SUR-32S / 03SUR-32S / 04SUR-32S.

**Best Mounting Direction: Any orientation.**

**UNIT : mm**

|  |            |               |               |   |
|--|------------|---------------|---------------|---|
| 建準電機工業股份有限公司<br>SUNONWEALTH ELECTRIC<br>MACHINE INDUSTRY CO., LTD. | SPEC.NO    | D01001051F-02 | REVISION DATE |   |
|  | ISSUE DATE | 10.17.2018    | EDITION       | 0 |
|  | PAGE       | 5 OF 12       |               |   |

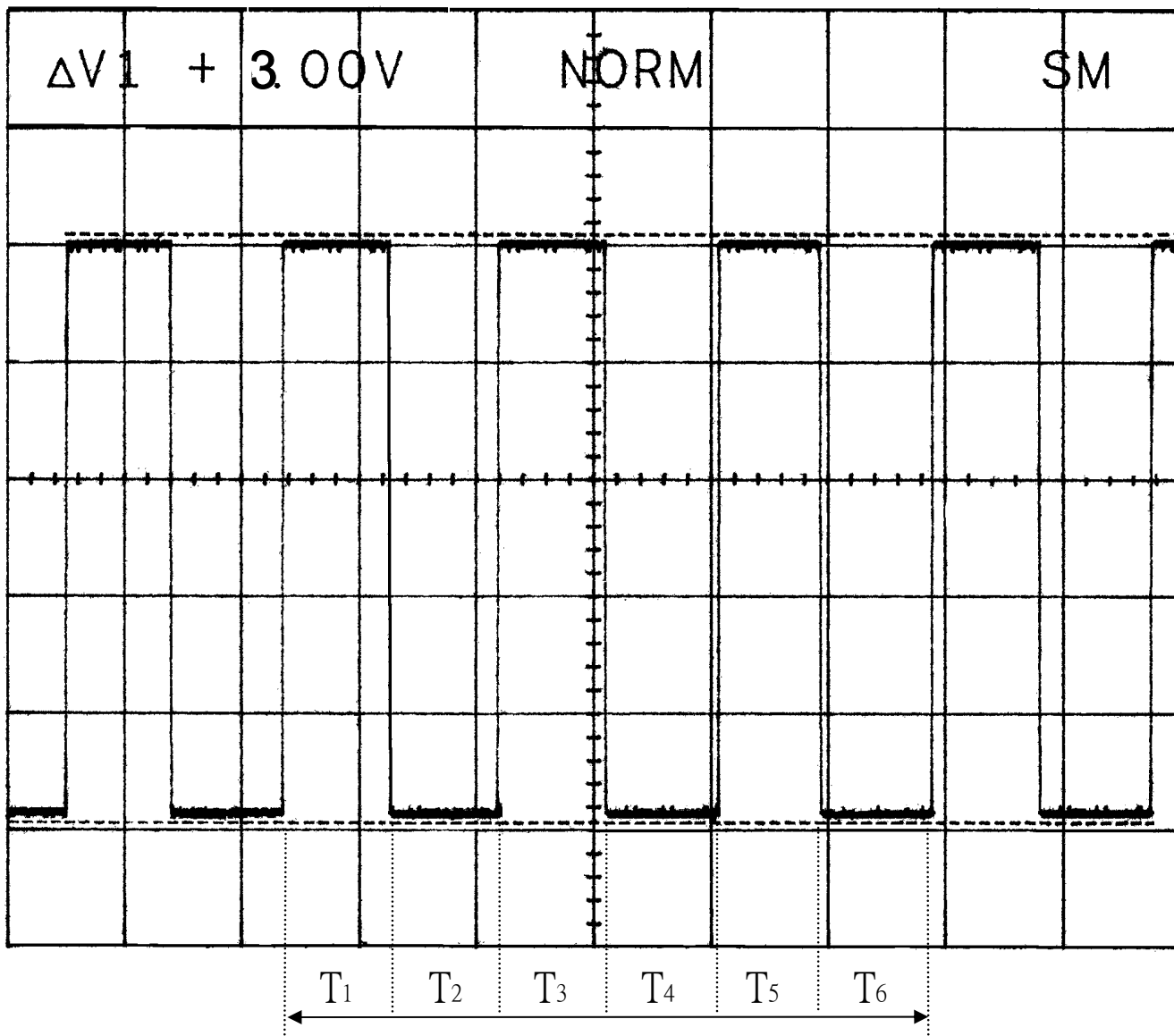

T=1 Rotation

$$T = T_1 + T_2 + T_3 + T_4 + T_5 + T_6 = (1 \text{ Rotation})$$

$$T = \frac{60}{\text{rpm}}$$

|            |               |               |   |
|------------|---------------|---------------|---|
| SPEC.NO    | D01001051F-02 | REVISION DATE |   |
| ISSUE DATE | 10.17.2018    | EDITION       | 0 |
| PAGE       | 6 OF 12       |               |   |

## FAN 3<sup>rd</sup> WIRE SIGNAL

● **F Type (Frequency Generator)**

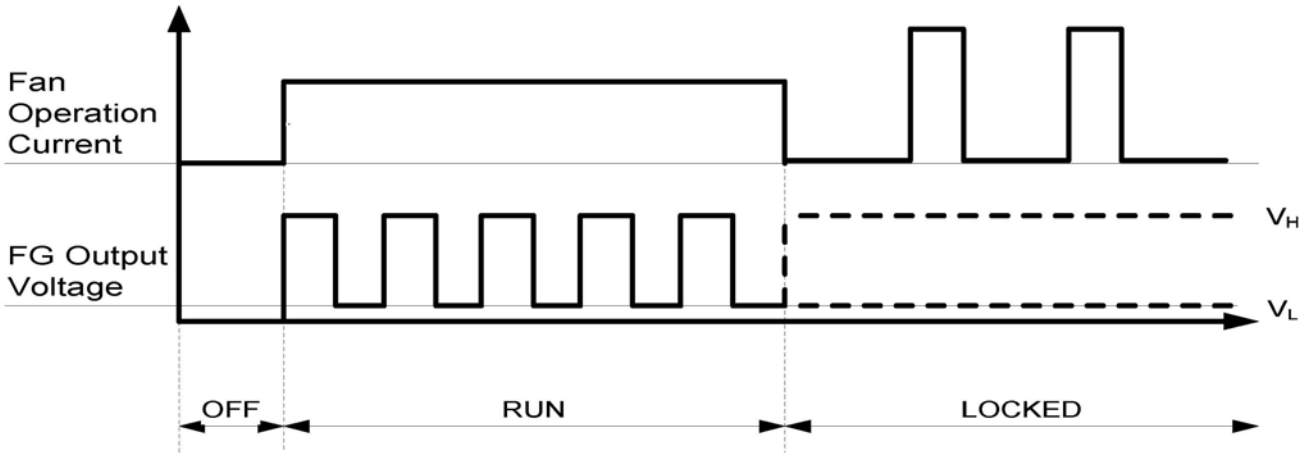
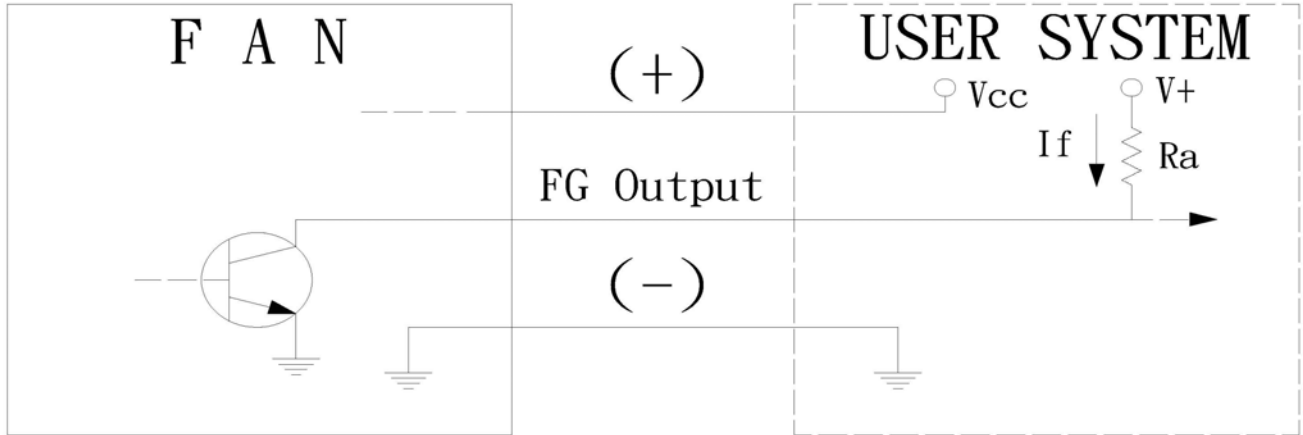

★Electrical Characteristics : ( at Ta = 25°C, V<sub>CC</sub>=3V)

| Parameter              | Ratings |      |     | Unit    |
|------------------------|---------|------|-----|---------|
|                        | min     | typ. | max |         |
| FG Supply Voltage(V+)  | --      | --   | 3.5 | Voltage |
| FG Output Current (If) | --      | --   | 4   | mA      |
| FG Output (VL)         | --      | --   | 0.5 | Voltage |
| FG Output (VH)         | --      | V+   | --  | Voltage |

# Notes

## I .SAFETY

1. **DO NOT use or operate this fan in excess of the limitations set forth in this specification. SUNON is not responsible for the non-performance of this fan and/or any damages resulting from its use, if it is not used or operated in accordance with the specifications.**
  
2. **SUNON recommends adding a protection circuit to the product or application in which this fan is installed, such as a thermo-fuse, or current-fuse or thermo-protector. The failure to use such a device may result in smoke, fire, electric shock by insulation degradation in cases of motor lead short circuit, overload, or over voltage, and/or other failure.**
  
3. **SUNON recommends installing a protection device to the product or application in which this fan is installed if there is a possibility of reverse-connection between VDC (+) and GND (-). The failure to install such a device may result in smoke, fire, and/or destruction, although these conditions may not manifest immediately.**
  
4. **This fan must be installed and used in compliance with all applicable safety standards and regulations.**
  
5. **Use proper care when handling and/or installing this fan. Improper handling or installation of this fan may cause damage that could result in unsafe conditions.**
  
6. **Use proper care during installation and/or wiring. Failure to use proper care may cause damage to certain components of the fan including, but not limited to, the coil and lead wires, which could result in smoke and/or fire.**
  
7. **DO NOT use power or ground PWM to control the fan speed. If the fan speed needs to be adjusted, please contact SUNON to customize the product design for your application.**
  
8. **For critical or extreme environments, including non stop operation, please contact SUNON and we will gladly provide assistance with your product selection to ensure an appropriate cooling product for your application.**

|  |                   |               |                      |   |
|--|-------------------|---------------|----------------------|---|
| 建準電機工業股份有限公司<br>SUNONWEALTH ELECTRIC<br>MACHINE INDUSTRY CO., LTD. | <b>SPEC.NO</b>    | D01001051F-02 | <b>REVISION DATE</b> |   |
|  | <b>ISSUE DATE</b> | 10.17.2018    | <b>E D I T I O N</b> | 0 |
|  | <b>P A G E</b>    | 8 OF 12       |                      |   |



# Notes

## II. SPECIFICATION MODIFICATION

1. **SUNON offers engineering assistance on fan installation and cooling system design.**
2. **All changes, modifications and/or revisions to the specifications, if any, are incorporated in the attached specifications.**
3. **No changes, modifications and/or revisions to these specifications are effective absent agreement, by both SUNON and the customer, in writing.**
4. **This fan will be shipped in accordance with the attached specification unless SUNON and the customer have agreed otherwise, in writing, as specified in Paragraph 3, above.**

## III. OTHER

1. **When building your device, please examine thoroughly any variation of EMC, temperature rise, life data, quality, etc. of this product by shock/drop/vibration testing, etc. If there are any problems or accidents in connection with this product, it should be mutually discussed and examined.**
2. **Use proper care when handling this fan. Components such as fan holders or bearings may be damaged, if touched with fingers or other objects. Additionally, static electricity (ESD) may damage the internal circuits of the fan.**
3. **DO NOT operate this fan in proximity to hazardous materials such as organic silicon, cyanogens, formalin, phenol, or corrosive gas environments including, but not limited to, H<sub>2</sub>S, SO<sub>2</sub>, NO<sub>2</sub>, or Cl<sub>2</sub>.**
4. **SUNON recommends that you protect this fan from exposure to outside elements such as dust, condensation, humidity or insects. Exposure of this fan to outside elements such as dust, condensation, humidity or insects may affect its performance and may cause safety hazards. SUNON does not warrant against damage to the product caused by outside elements.**  
**Re: The term can be excluded, if the fan has been with IP design and meets customer's IP requirement.**

|  |            |               |               |   |
|--|------------|---------------|---------------|---|
| 建準電機工業股份有限公司<br>SUNONWEALTH ELECTRIC<br>MACHINE INDUSTRY CO., LTD. | SPEC.NO    | D01001051F-02 | REVISION DATE |   |
|  | ISSUE DATE | 10.17.2018    | E D I T I O N | 0 |
|  | P A G E    | 9 O F 12      |               |   |

## Notes

5. **This fan must be installed properly and securely. Improper mounting may cause harsh resonance, vibration, and noise.**
  
6. **Fan guards may prevent injury during handling or installation of the fan and are available for sale with this fan.**
  
7. **Unless otherwise noted, all testing of this fan is conducted at 25°C ambient temperature and sixty-five percent (65%) relative humidity.**
  
8. **DO NOT store this fan in an environment with high humidity. This fan must be stored in accordance with the attached specifications regarding storage temperature. If this fan is stored for more than 6 months, SUNON recommends functional testing before using.**
  
9. **SUNON reserves the right to use components from multiple sources at its discretion. The use of components from other sources will not affect the specifications as described herein.**
  
10. **The “Life Expectancy” of this fan has not been evaluated for use in combination with any end application. Therefore, the Life Expectancy Test Reports (L10 and MTTF Report) that relate to this fan are only for reference.**

## VI. WARRANTY

**This fan is warranted against all defects which are proved to be fault in our workmanship and material for one year from the date of our delivery. The sole responsibility under the warranty shall be limited to the repair of the fan or the replacement thereof, at SUNON’s sole discretion. SUNON will not be responsible for the failures of its fans due to improper handing, misuse or the failure to follow specifications or instructions for use. In the event of warranty claim, the customer shall immediately notify SUNON for verification. SUNON will not be responsible for any consequential damage to the customer’s equipment as a result of any fans proven to be defective.**

|  |                   |                      |                      |          |
|--|-------------------|----------------------|----------------------|----------|
| 建準電機工業股份有限公司<br>SUNONWEALTH ELECTRIC<br>MACHINE INDUSTRY CO., LTD. | <b>SPEC.NO</b>    | <b>D01001051F-02</b> | <b>REVISION DATE</b> |          |
|  | <b>ISSUE DATE</b> | <b>10.17.2018</b>    | <b>E D I T I O N</b> | <b>0</b> |
|  | <b>P A G E</b>    | <b>10 OF 12</b>      |                      |          |



## Declaration of Restricted Materials

### Control declaration of environment- related substances/ materials

1. In accordance with the Restriction of Hazardous Substances (RoHS) Directive 2011/65/EU and specific market requirements, Sunon Halogen-Free Product have complied with law and discipline not to employ the forbidden substances, and restrict the allowable concentration of some limited substances deliberately in our components.

| No | Substance  | Criteria  |          |
|----|--|---|----------|
| 1  | CFCs & HCFCs (ozone depleting substances)  | Forbidden   |          |
| 2  | Chlorinated Organic Solvent  | Forbidden   |          |
| 3  | Lead and its compounds   | Plastic (Frame, Impeller, wire harness, etc.)                               | <100ppm  |
|    |  | Solder  | <1000ppm |
|    |  | Steel alloy   | <3500ppm |
|    |  | Aluminium alloy   | <4000ppm |
|    |  | Copper alloy  | <4wt%    |
| 4  | Cadmium and its compounds  | Solder  | <20ppm   |
|    |  | Parts composed of metals containing zinc (e.g. brass, zinc for die casting) | <100ppm  |
|    |  | Plastic   | <5ppm    |
| 5  | PBBs and PBDEs   | Forbidden   |          |
| 6  | PCB and PCT  | Forbidden   |          |
| 7  | CP, Short-chain Chlorinated paraffins C10-13, Cl ≥48 wt%   | Forbidden   |          |
| 8  | Mirex  | Forbidden   |          |
| 9  | PCN  | Forbidden   |          |
| 10 | Hexavalent Chromium compounds  | <100ppm   |          |
| 11 | Mercury and its compounds  | Forbidden   |          |
| 12 | Asbestos   | Forbidden   |          |
| 13 | Organic Tin compounds  | Forbidden   |          |
| 14 | Azo compounds  | Forbidden   |          |
| 15 | TBBP-A in external case plastic parts of products (PCB is exempted)  | <1000ppm  |          |
| 16 | Nickel in external case parts, which are likely to result in prolonged skin exposure   | <1000ppm  |          |
| 17 | Hexabromocyclododecane (HBCDD)   | <1000ppm  |          |
| 18 | Di-butyl Phthalate (DBP)   | <1000ppm  |          |
| 19 | Benzyl butyl Phthalate (BBP)   | <1000ppm  |          |
| 20 | Di-ethylhexyl Phthalate (DEHP)   | <1000ppm  |          |
| 21 | Di-isobutyl Phthalate (DIBP)   | <1000ppm  |          |
| 22 | Brominated/chlorinated flame retardants (other than PBBs or PBDEs), applicable item: frame, bobbin, impeller, lear wire, connector, mylar insulator. | Br<900ppm<br>Cl<900ppm<br>Br+Cl<1500ppm                                     |          |
| 23 | PAHs and its 16 compounds in unusual contact material  | BaP < 20ppm<br>Total <200ppm  |          |
| 24 | PCB and electroplating material, PFOS content complianced with 2006/122/EC   | PFOS ≤1000ppm;<br>coating material<br>PFOS ≤ 1μg/m <sup>2</sup>             |          |

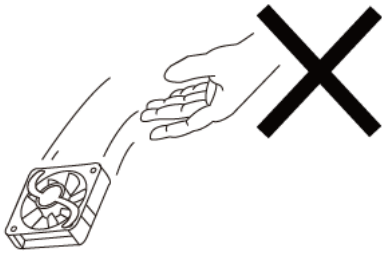
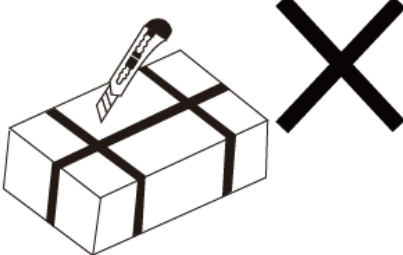
# Notes

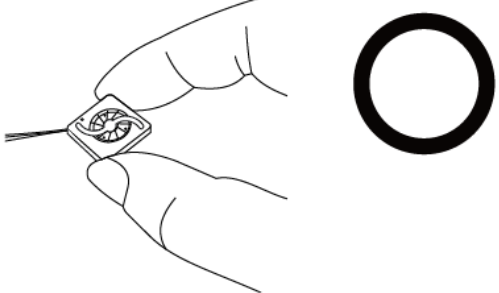
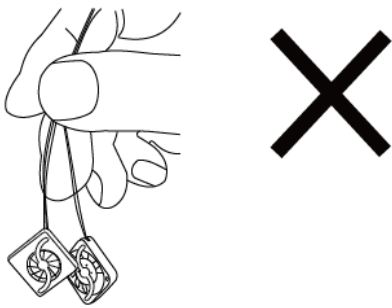
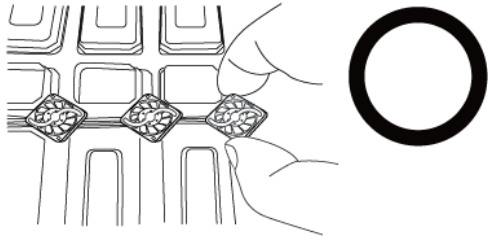
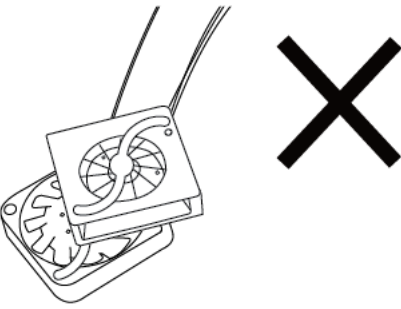
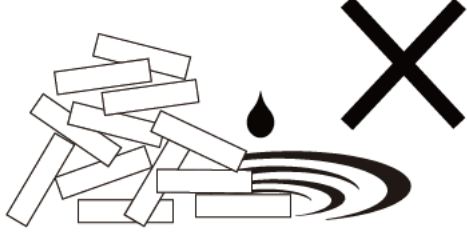
|   |  |   |
|---|--|---|
| <p><b>Don't drop.</b></p>    | <p><b>Don't cut the fan or lead wires</b></p>  | <p><b>Handle with care!</b></p>  |
| <p><b>Don't push the fan blade.</b></p>    |  |   |
| <p><b>Don't pull fan with lead wires.</b></p>                                        |  |   |
| <p><b>Don't dump fans on top of each others and keep away from humid area.</b></p>   |  |   |