

WKSAGVDXG

ATTENTION: This module requires device drivers that are under Japan export control. Depending on the customer's country and application (e.g. weapons), Taiyo Yuden may not be able to provide these drivers to all customers. Please contact your local Taiyo Yuden sales office for additional information.

To contact your local sales office and for additional product information, please visit www.ty-top.com.

TABLE OF CONTENTS

INTRODUCTION	4
CONFORMITY MODULE	4
ACCESSORIES.....	4
THE EXAMPLE OF CONNECTION	4
EVALUATION BOARD LAYOUT.....	5
PIN DESCRIPTION OF EVALUATION BOARD	5
BOM OF EVALUATION BOARD.....	6 - 7
SCHEMATIC OF EVALUATION BOARD.....	8-10

Rev. Records

May.19.2019> Ver.1.0 Release

Jul.02.2019> Ver.1.1 Update

Introduction

This evaluation kit is developed for communication test of **Wireless LAN** and **Bluetooth®** module which TAIYO YUDEN develops and sells.

This evaluation kit makes it possible to perform easily the communication test of **Wireless LAN** and **Bluetooth®** module of TAIYO YUDEN CO., LTD.

Conformity module

WYSAGVDXG

Accessories

1	Evaluation Board (WBSAGVDXG)	1 piece
2	DC Power Cable	1 piece
3	ESPRESSObin	1 piece
4	AC Adapter	1 piece
5	USB Memory	1 piece
6	USB Cable	1 piece
7	SD – Micro SD Conversion Cable	1 piece

The example of connection

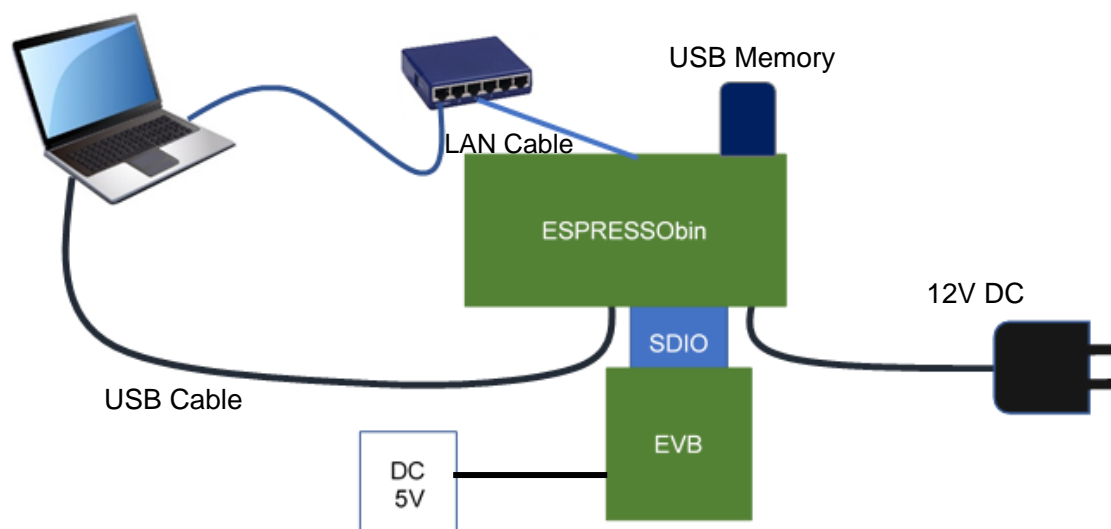

Evaluation board layout

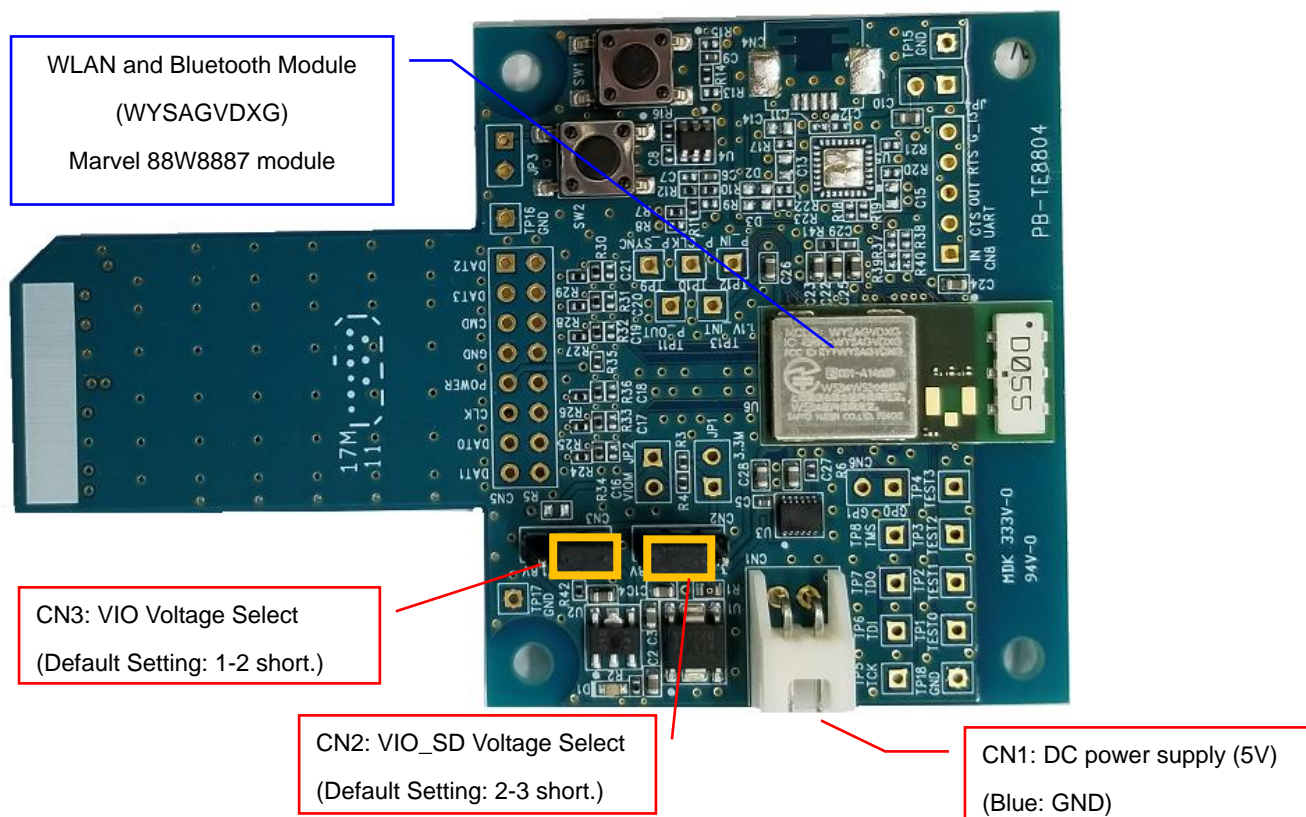

Pin description of evaluation board

WBSAGVDXG (TE8804)

CN1: DC Power Supply

No.	Pin name	Direction	Description
1	5V	Input	5.0V input.
2	GND	GND	Ground

CN2: VIO_SD Voltage Select (Default Setting: 2-3 short.)

No.	Pin name	Direction	Description
1	3.3V	Output	3.3V output.
2	VIO_SD	Input	Input for VIO_SD.
3	1.8V	Output	1.8V output.

CN3: VIO Voltage Select (Default Setting: 1-2 short.)

No.	Pin name	Direction	Description
1	3.3V	Output	3.3V output.
2	VIO	Input	Input for VIO.
3	1.8V	Output	1.8V output.

WKSAGVDXG

TAIYO YUDEN CO., LTD.

BOM of evaluation board

WBSAGVDXG (TE8804)

Ref Name	Description	Parts name	Supplier
U1	IC(LDO 3.3V)	S-1172B33-E6T1G	SII or equivalent
U2	IC(LDO1.8V)	S-1170B18UC-OTDTF	SII or equivalent
U3	IC(32.768kHz clock)	SG-3030LC	EPSON or equivalent
U4	IC	TPS3808G01DBVT	TI or equivalent
U5	N.M	N.M.	
U6	Module	WYSAGVDXG	TAIYO YUDEN
SW1	SWITCH	HP03-15AFKP2	NKK SWITCHES or equivalent
SW2	SWITCH	HP03-15AFKP2	NKK SWITCHES or equivalent
CN1	CONNECTOR	S2B-XH-A	JST or equivalent
CN2	CONNECTOR	PIN_HEADER_S3	
CN3	CONNECTOR	PIN_HEADER_S3	
CN4-CN8	N.M.	N.M.	
JP1-JP4	N.M.	N.M.	
C1	CAPACITOR	LMK107 BJ475KA	TAIYO YUDEN
C2	CAPACITOR	LMK107 BJ475KA	TAIYO YUDEN
C3	CAPACITOR	LMK107 BJ475KA	TAIYO YUDEN
C4	CAPACITOR	LMK107 BJ475KA	TAIYO YUDEN
C5	CAPACITOR	EMK105 BJ104KV	TAIYO YUDEN
C6	CAPACITOR	EMK105 BJ104KV	TAIYO YUDEN
C7-C8	N.M.	N.M.	
C9	CAPACITOR	EMK105 BJ104KV	TAIYO YUDEN
C10	CAPACITOR	JMK107 BJ106MA	TAIYO YUDEN
C11-C21	N.M.	N.M.	
C22	CAPACITOR	JMK107 BJ106MA	TAIYO YUDEN
C23	CAPACITOR	JMK107 BJ106MA	TAIYO YUDEN
C24	CAPACITOR	JMK107 BJ106MA	TAIYO YUDEN
C25	CAPACITOR	JMK107 BJ106MA	TAIYO YUDEN
C26	CAPACITOR	JMK107 BJ106MA	TAIYO YUDEN
C27	CAPACITOR	JMK107 BJ106MA	TAIYO YUDEN
C28	CAPACITOR	JMK107 BJ106MA	TAIYO YUDEN
C29	CAPACITOR	UMK105 CH100CV-F	TAIYO YUDEN
R1	RESISTOR	MCR03EZJH000	ROHM or equivalent
R2	RESISTOR	MCR01 MRT J 470	ROHM or equivalent

WKSAGVDXG

TAIYO YUDEN CO., LTD.

Ref Name	Description	Parts name	Supplier
R3	RESISTOR	MCR01 MRT J000	ROHM or equivalent
R4	RESISTOR	MCR01 MRT J000	ROHM or equivalent
R5	N.M.	N.M.	
R6	RESISTOR	MCR01 MRT J000	ROHM or equivalent
R7	RESISTOR	MCR01 MRT J000	ROHM or equivalent
R8-R9	N.M.	N.M.	
R10	RESISTOR	MCR01 MRT J000	ROHM or equivalent
R11	RESISTOR	MCR01 304J	ROHM or equivalent
R12	RESISTOR	MCR01 MRT J104	ROHM or equivalent
R13	N.M.	N.M.	
R14	RESISTOR	MCR01 MRT J000	ROHM or equivalent
R15	N.M.	N.M.	
R16	RESISTOR	MCR01 MRT J000	ROHM or equivalent
R17-R23	N.M.	N.M.	
R24	RESISTOR.	MCR01 MRT J220	ROHM or equivalent
R25	RESISTOR.	MCR01 MRT J220	ROHM or equivalent
R26	RESISTOR.	MCR01 MRT J220	ROHM or equivalent
R27	RESISTOR.	MCR01 MRT J220	ROHM or equivalent
R28	RESISTOR.	MCR01 MRT J220	ROHM or equivalent
R29	RESISTOR.	MCR01 MRT J220	ROHM or equivalent
R30	RESISTOR	MCR01 MRT J473	ROHM or equivalent
R31	RESISTOR	MCR01 MRT J473	ROHM or equivalent
R32	RESISTOR	MCR01 MRT J473	ROHM or equivalent
R33	RESISTOR	MCR01 MRT J473	ROHM or equivalent
R34	RESISTOR	MCR01 MRT J473	ROHM or equivalent
R35	RESISTOR	MCR01 MRT J102	ROHM or equivalent
R36	RESISTOR	MCR01 MRT J473	ROHM or equivalent
R37-R40	N.M.	N.M.	
R41	RESISTOR	MCR01 MRT J104	ROHM or equivalent
R42	RESISTOR	MCR01 103J	ROHM or equivalent
D1	LED	SML-D12M	ROHM or equivalent
D2-D3	N.M.	N.M.	
TP1-13	N.M.	N.M.	
TP15-18	N.M.	N.M.	

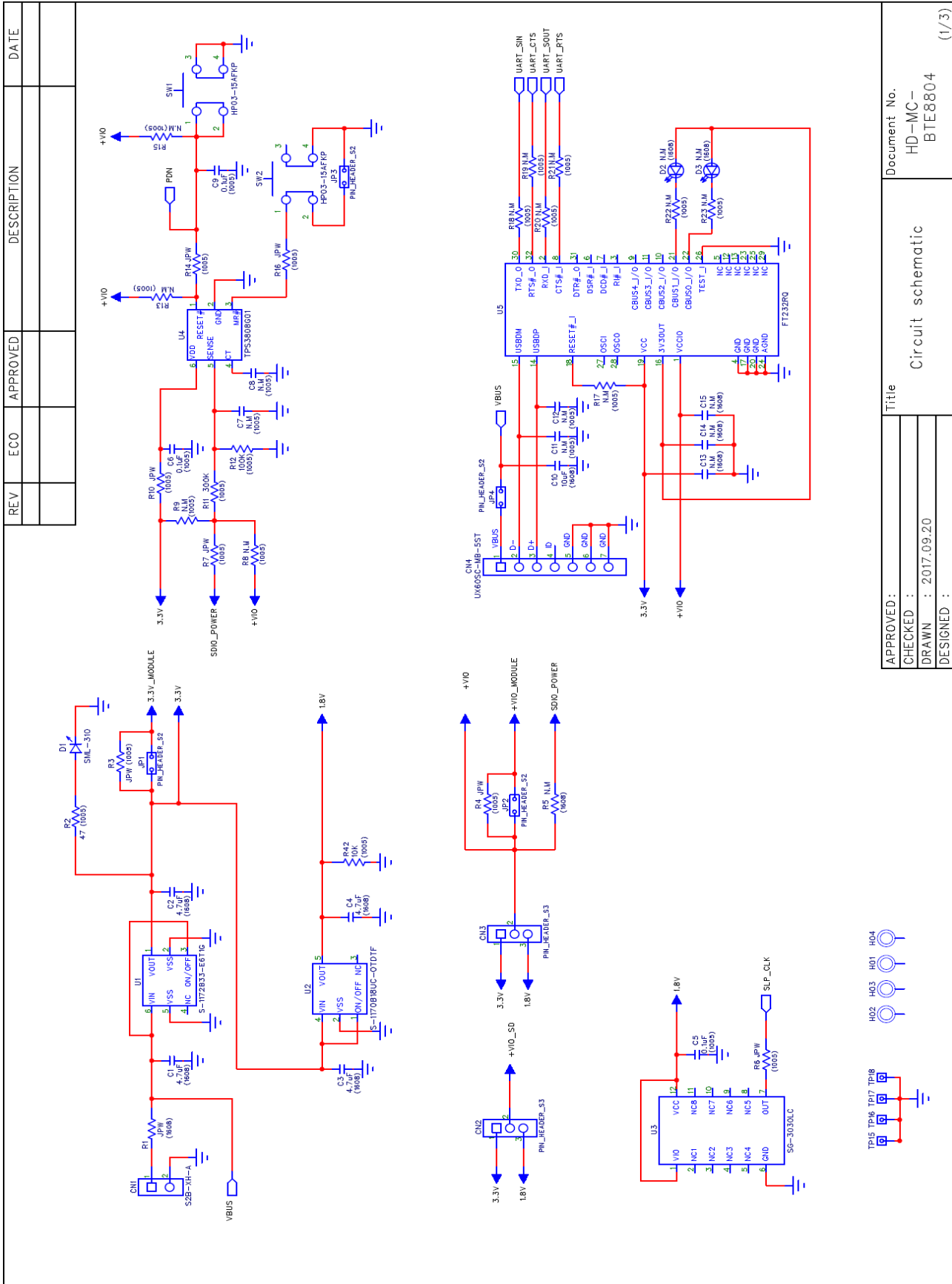

APPROVED :	Document No.
CHECKED :	HD-MC-
DRAWN : 2017.09.20	BTE8804
DESIGNED :	(1/3)

Title	Circuit schematic
-------	-------------------

WKSAGVDXG

TAIYO YUDEN CO., LTD.

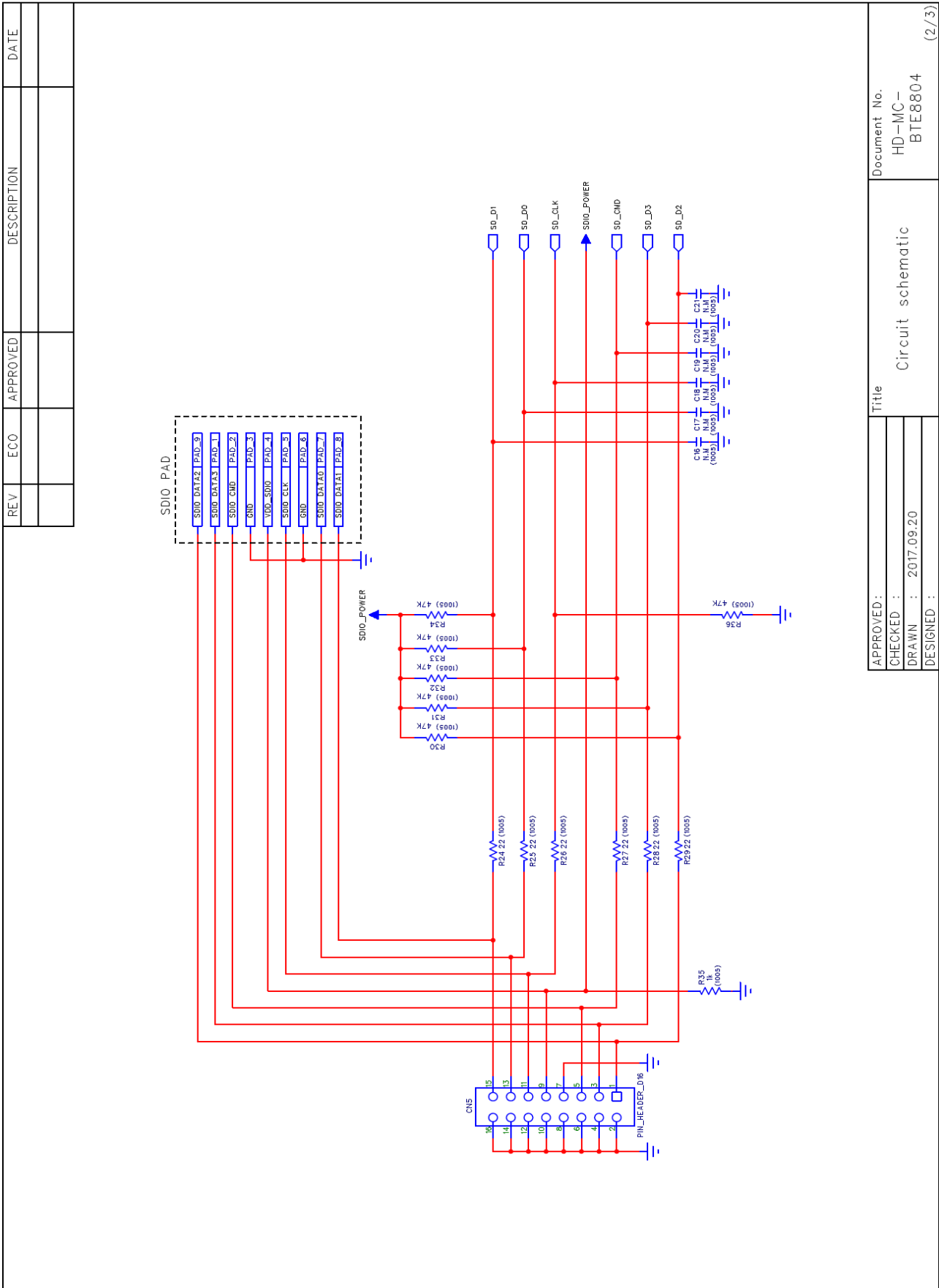

Title	Document No.
APPROVED :	HD-MC-
CHECKED :	BTE8804
DRAWN : 2017.09.20	(2/3)
DESIGNED :	

WKSAGVDXG

TAIYO YUDEN CO., LTD.

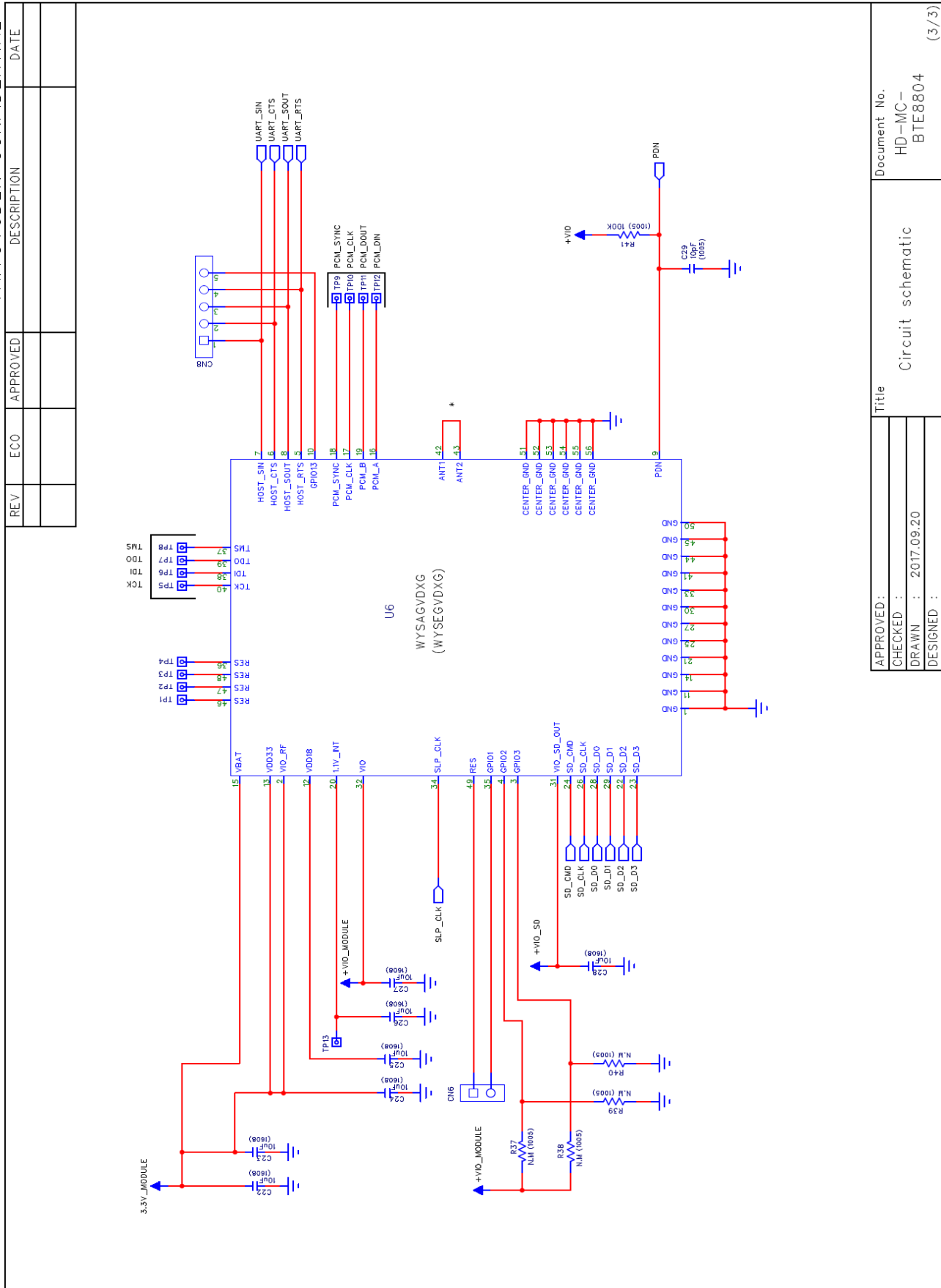

APPROVED :	Title	Document No.
CHECKED :	Circuit schematic	HD-MC-
DRAWN : 2017.09.20		BTE8804
DESIGNED :		(3/3)

Evaluation guide book of TAIYO YUDEN Wireless Module on the ESPRESSObin (88W8887)

Version 1.1: 24-May-2019

1.	BLOCK DIAGRAM FOR H/W.....	2
2.	OPEN SERIAL CONSOLE ON THE PC	4
3.	POWER ON THE ESPRESSOBIN.....	5
4.	LOAD WLAN AND BLUETOOTH DRIVER.....	6
4.1	WLAN OPERATION CHECK.....	7
4.2	BLUETOOTH OPERATION CHECK.....	10
4.3	WPA_SUPPLICANT OPERATION CHECK.....	10
4.4	HOSTAPD OPERATION CHECK.....	11
5.	MANUFACTURING UTILITY (MFG).....	12
5.1	WIRED NETWORK SETTINGS	12
5.2	LOAD WLAN AND BLUETOOTH DRIVER WITH MFG FIRMWARE.....	12
5.3	RUN “MFG BRIDGE” APPLICATION	13
6.	ABOUT SDIO SWITCHING.....	15

1. Block Diagram for H/W

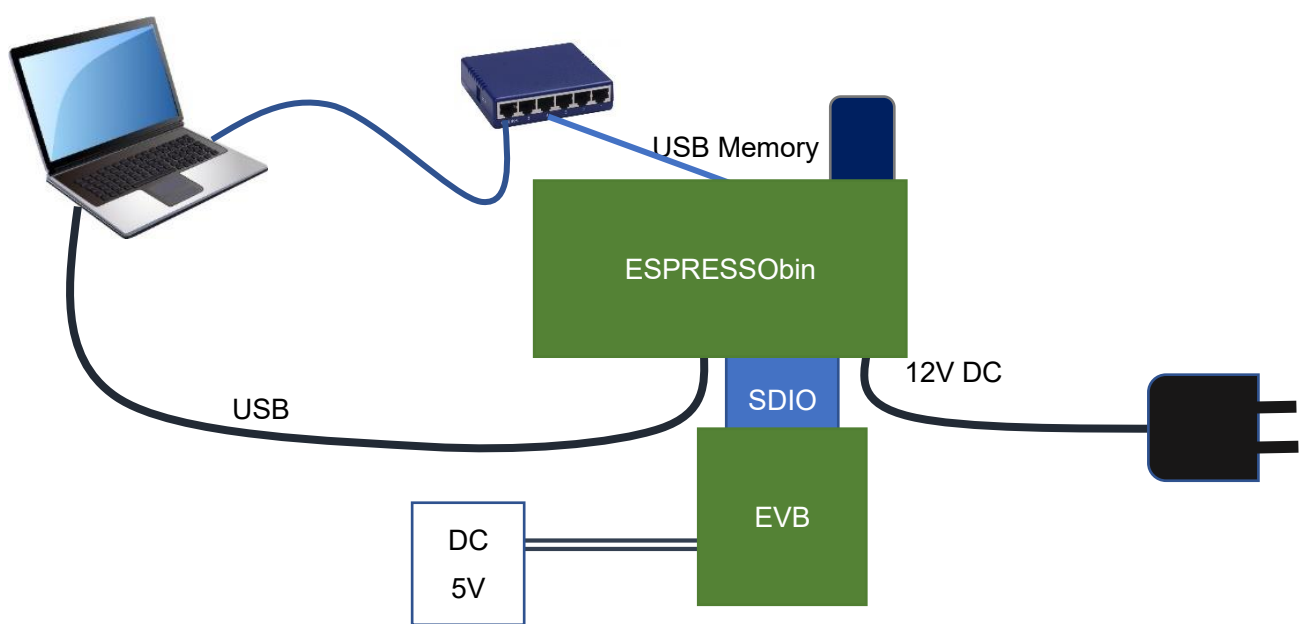

Detailed Block Diagram

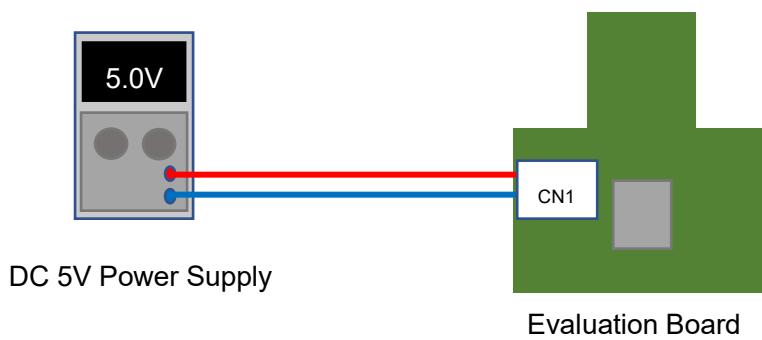
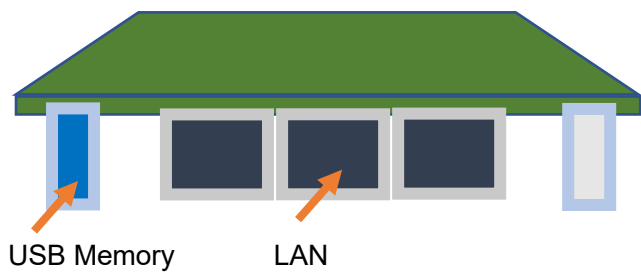
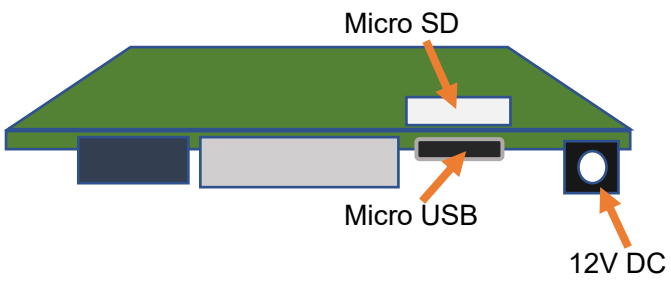

2. Open serial console on the PC

First connect the ESPRESSObin and the PC with the USB cable.

ESPRESSObin power supply remains OFF.

Open the corresponding port with serial communication software. (terminal software)

Follow the tutorial for your OS to make sure you have everything needed.

Windows:

<http://wiki.espressobin.net/tiki-index.php?page=Serial+connection+-+Windows>

Linux

<http://wiki.espressobin.net/tiki-index.php?page=Serial+connection+-+Linux>

For example

Tera Term on the Windows PC

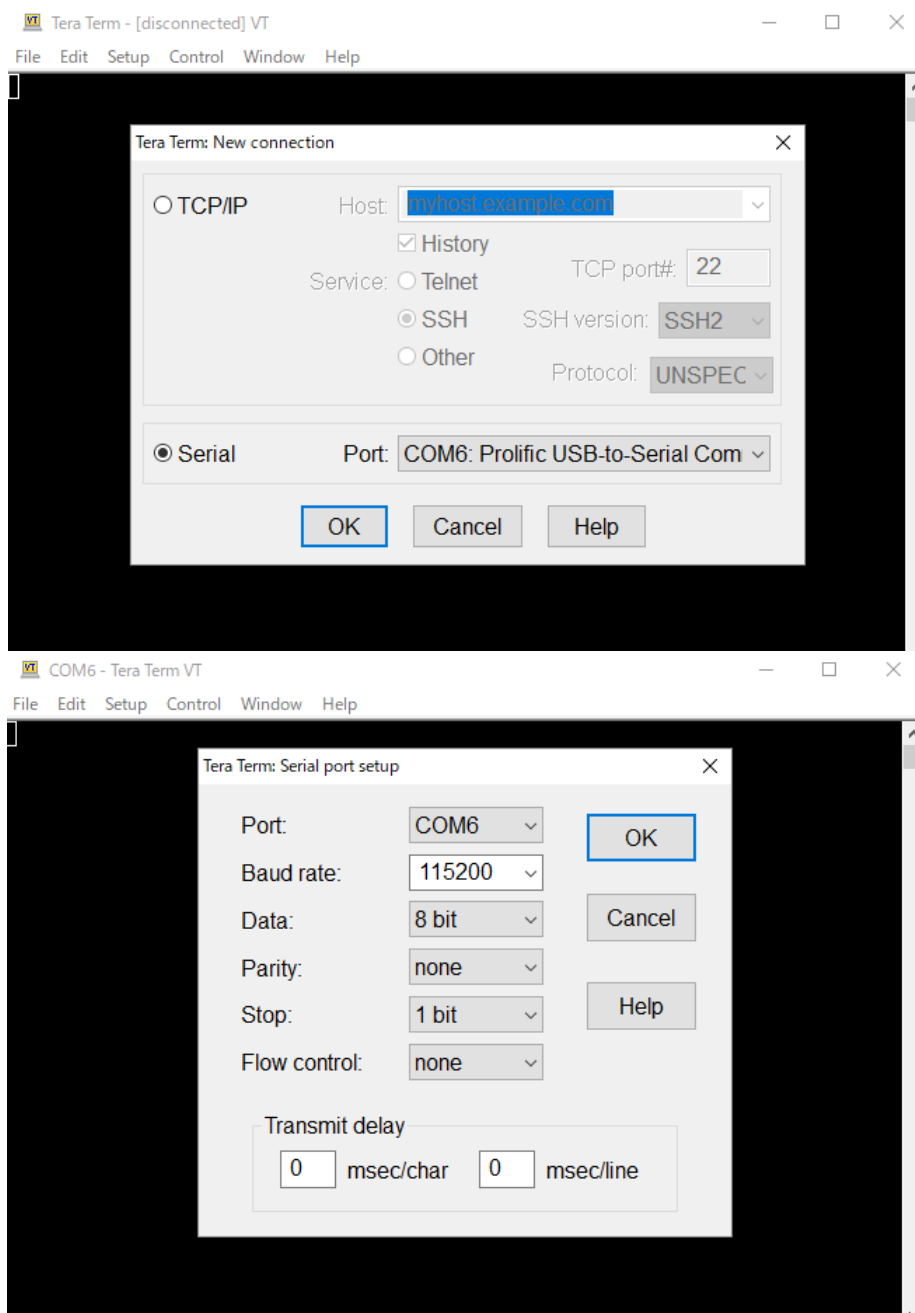

3. Power on the ESPRESSObin

Plug your power adapter to the 12V DC Jack.

When the ESPRESSObin starts to boot, you can check following messages.

```
TIM-1.0
WTMI-armada-17.10.1-b90dbf0
ENTER init_ddrgen
DDR_TOPOLOGY is 4 :    DDR3, 1CS 1G
WTMI_CLOCK=2
    ⏪ (skip)
MMC:   sdhci@d0000: 0, sdhci@d8000: 1
SF: Detected w25q32dw with page size 256 Bytes, erase size 4 KiB, total 4 MiB
Net:   eth0: neta@30000 [PRIME]
Hit any key to stop autoboot:  0
    Please press "ENTER" key when the above message is displayed.
Marvell>>
```

Enter the following in order. (**Blue** letter part)

```
Marvell>> run bootusb
starting USB...
USB0:   Register 2000104 NbrPorts 2
Starting the controller
    ⏪ (skip)
Ubuntu 14.04 LTS localhost.localdomain ttyMV0

localhost login: root (automatic login)

Last login: Thu Jan  1 00:00:20 UTC 1970 on ttyMV0
Welcome to Ubuntu 14.04.5 LTS (GNU/Linux 4.4.8-armada-17.02.2-g8148be9-dirty aarch64)
```

When the ESPRESSObin starts normally, you can check above message.

“bootusb” works with SDIO 3.0. (ultra-high speed)

If you want to operate with SDIO 2.0 (high speed), please change to "bootusbH". (**run bootusbH**)

Refer to “6. About SDIO switching” for setting on the evaluation board.

4. Load WLAN and Bluetooth driver

```
root@localhost:~# cd /home/8887/bin_sd8887
root@localhost:/home/8887/bin_sd8887# insmod mlan.ko
root@localhost:/home/8887/bin_sd8887# insmod sd8887.ko cal_data_cfg=none
[ 169.071741] wlan: Loading MWLAN driver
[ 169.076218] wlan: Driver loaded successfully
root@localhost:/home/8887/bin_sd8887# cd ../bin_sd8887_bt/
root@localhost:/home/8887/bin_sd8887_bt# insmod bt8887.ko
[ 178.215970] BT: Loading driver
[ 178.219525] BT: Driver loaded successfully
root@localhost:/home/8887/bin_sd8887_bt#
```

Turn on the power of the 88w8887 evaluation board and insert it into SDIO of ESPRESSObin.

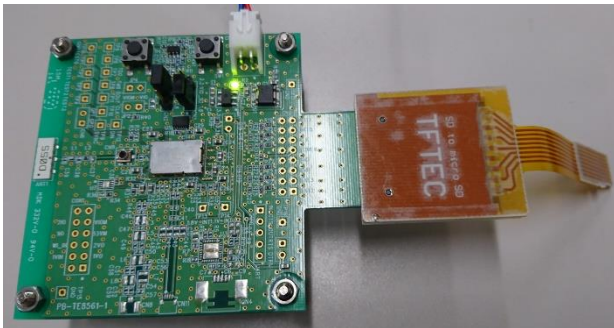

Turn on the power of evaluation board and insert it in SD-Converter.

Insert it in microSD slot of ESPRESSObin.

The evaluation board will be recognized and the following message will be displayed.

```
root@localhost:/home/8887/bin_sd8887_bt# [ 68.499234] vendor=0x02DF device=0x9135 class=0 function=1
[ 68.504945] SDIO: max_segs=128 max_seg_size=65536
[ 68.509804] rx_work=1 cpu_num=2
[ 68.524226] Request firmware: mrvl/sd8887_uapsta_a2.bin
[ 69.651638] WLAN FW is active
[ 74.665275] wlan: version = SD8887-15.68.7.p189-C4X15C605-GPL-(FP68)
[ 74.673418] ahci-mvebu d00e0000.sata: couldn't get PHY in node sata: -517
[ 74.696088] orion-ehci d005e000.usb: init d005e000.usb fail, -517
[ 74.721036] ahci-mvebu d00e0000.sata: couldn't get PHY in node sata: -517
root@localhost:/home/8887/bin_sd8887_bt#
```

When the driver install succeed, you can check “WLAN FW is active” message.

*If “WLAN FW is active” is not displayed, remove the evaluation board from the SD slot, turn the power of the evaluation board on again, and insert it in the SD slot again.

4.1 WLAN operation check

Confirmation of wireless LAN interface

root@localhost:/home/8887/bin_sd8887_bt# iwconfig

```
m1an0 IEEE 802.11-DS ESSID:""  
Mode:Managed Access Point: Not-Associated Bit Rate:1 Mb/s  
Tx-Power=17 dBm  
Retry limit:9 RTS thr=2347 B Fragment thr=2346 B  
Encryption key:off  
Power Management:on  
Link Quality=0/5 Signal level=0 dBm Noise level=0 dBm  
Rx invalid nwid:0 Rx invalid crypt:0 Rx invalid frag:0  
Tx excessive retries:0 Invalid misc:0 Missed beacon:0  
  
wfd0 IEEE 802.11-DS ESSID:""  
Mode:Managed Access Point: Not-Associated Bit Rate:1 Mb/s  
Tx-Power=17 dBm  
Retry limit:9 RTS thr=2347 B Fragment thr=2346 B  
Encryption key:off  
Power Management:on  
Link Quality=0/5 Signal level=0 dBm Noise level=0 dBm  
Rx invalid nwid:0 Rx invalid crypt:0 Rx invalid frag:0  
Tx excessive retries:0 Invalid misc:0 Missed beacon:0  
  
uap0 IEEE 802.11-DS ESSID:""  
Mode:Master Frequency:2.437 GHz Access Point: Not-Associated  
Encryption key:off  
Link Quality:0 Signal level:0 Noise level:0  
Rx invalid nwid:0 Rx invalid crypt:0 Rx invalid frag:0  
Tx excessive retries:0 Invalid misc:0 Missed beacon:0
```

Perform a "scan"

root@localhost:/home/8887/bin_sd8887_bt# iwlist wlan0 scan

wlan0 Scan completed :

Cell 01 - Address: 1C:*.:.:.:.:.:.*

ESSID:"WG1400HP-2G" [4]

Mode:Master

Frequency=2.417 GHz (Channel 2)

Quality:5/5 Signal level:-45 dBm Noise level:-96 dBm

Encryption key:on

Bit Rates:1 Mb/s; 2 Mb/s; 5.5 Mb/s; 11 Mb/s; 6 Mb/s

9 Mb/s; 12 Mb/s; 18 Mb/s; 24 Mb/s; 36 Mb/s

48 Mb/s; 54 Mb/s

Extra:Beacon interval=100

IE: IEEE 802.11i/WPA2 Version 1

Group Cipher : CCMP

Pairwise Ciphers (1) : CCMP

Authentication Suites (1) : PSK

Cell 02 - Address: 1C:*.:.:.:.:.:.*

ESSID:"WG1400HP-5G" [24]

Mode:Master

Frequency=5.18 GHz (Channel 36)

Quality:5/5 Signal level:-42 dBm Noise level:-96 dBm

Encryption key:on

Bit Rates:6 Mb/s; 9 Mb/s; 12 Mb/s; 18 Mb/s; 24 Mb/s

36 Mb/s; 48 Mb/s; 54 Mb/s

Extra:Beacon interval=100

IE: IEEE 802.11i/WPA2 Version 1

Group Cipher : CCMP

Pairwise Ciphers (1) : CCMP

Authentication Suites (1) : PSK

4.2 Bluetooth operation check

Confirmation of wireless Bluetooth interface

```
root@localhost:/home/8887/bin_sd8887_bt# hciconfig
hci0:  Type: BR/EDR  Bus: SDIO
       BD Address: AC:3F:A4:84:D1:89  ACL MTU: 1021:7  SCO MTU: 120:6
       UP RUNNING PSCAN
       RX bytes:918 acl:0 sco:0 events:42 errors:0
       TX bytes:1182 acl:0 sco:0 commands:42 errors:0
```

Perform a "inquiry" and "connection"

```
root@localhost:/home/8887/bin_sd8887_bt# hcitool -i hci0 scan
```

Scanning ...

```
XX:D2:24:BA:9C:02      n/a
XX:E0:10:E2:48:89     n/a
XX:CB:57:6A:9A:5C     n/a
E4:A7:A0:4A:C7:42     H00028472-PC
```

```
root@localhost:/home/8887/bin_sd8887_bt# hcitool -i hci0 cc E4:A7:A0:4A:C7:42
```

```
root@localhost:/home/8887/bin_sd8887_bt# hcitool -i hci0 con
```

Connections:

```
< ACL E4:A7:A0:4A:C7:42 handle 1 state 1 lm SLAVE
```

4.3 wpa_supplicant operation check

```
root@localhost:/home/8887/bin_sd8887_bt# cd /home/wpa_supplicant/
```

```
root@localhost:/home/wpa_supplicant# wpa_supplicant -Dwext -imlan0 -c ./wpa01.conf
```

Successfully initialized wpa_supplicant

rftkill: Cannot open RFKILL control device

ioctl[SIOCSIWESSID]: Bad address

mlan0: Trying to associate with 1c:b1:7f:e4:82:22 (SSID='WG1400HP-2G' freq=2417 MHz)

mlan0: Associated with 1c:b1:7f:e4:82:22

mlan0: WPA: Key negotiation completed with 1c:b1:7f:e4:82:22 [PTK=CCMP GTK=CCMP]

mlan0: CTRL-EVENT-CONNECTED - Connection to 1c:b1:7f:e4:82:22 completed [id=0 id_str=]

*Please create "conf" file according to your environment and use it.

4.4 hostapd operation check

Confirmation of hostapd is done by loading WLAN driver.

```
root@localhost:~# cd /home/hostapd/bin_sd8887_hostapd/
root@localhost:/home/hostapd/bin_sd8887_hostapd# insmod mlan.ko
root@localhost:/home/hostapd/bin_sd8887_hostapd# insmod sd8887.ko cal_data_cfg=None
[ 48.945206] wlan: Loading MWLAN driver
[ 48.950034] wlan: Driver loaded successfully
root@localhost:/home/hostapd/bin_sd8887_hostapd# [ 67.816250] vendor=0x02DF device=0x9135 class=0
function=1
[ 67.821827] SDIO: max_segs=128 max_seg_size=65536
[ 67.826581] rx_work=1 cpu_num=2
[ 67.833097] Request firmware: mrvl/sd8887_uapsta_a2.bin
[ 68.959540] WLAN FW is active
[ 73.962215] creating custom regulatory domain failed
[ 73.990290] wlan: version = SD8887-15.68.7.p189-C4X15C605-GPL-(FP68)
[ 73.998035] orion-ehci d005e000.usb: init d005e000.usb fail, -517
[ 74.006669] ahci-mvebu d00e0000.sata: couldn't get PHY in node sata: -517
[ 74.049723] orion-ehci d005e000.usb: init d005e000.usb fail, -517
[ 74.057792] ahci-mvebu d00e0000.sata: couldn't get PHY in node sata: -517
```

*Please create "conf" file according to your environment and use it.

```
root@localhost:/home/hostapd/bin_sd8887_hostapd# cd ..
root@localhost:/home/hostapd# hostapd ./test_hostapd.conf
Configuration file: ./test_hostapd.conf
rfkill: Cannot open RFKILL control [ 246.128457] get_channel when AP is not started device
[ 246.137962] get_channel when AP is not started
[ 246.143303] get_channel when AP is not started
uap0: interface state UNINITIALIZED->COUNTRY_UPDATE
Using interface uap0 with hwaddr ac:3f:a4:84:d2:88 and ssid "ESP_AP_test"
[ 246.233170] wlan: Starting AP
[ 246.248426] wlan: AP started
[ 246.253711] Set AC=3, txop=47 cwmin=3, cwmax=7 aifs=1
[ 246.259356] Set AC=2, txop=94 cwmin=7, cwmax=15 aifs=1
[ 246.265744] Set AC=0, txop=0 cwmin=15, cwmax=63 aifs=3
[ 246.271371] Set AC=1, txop=0 cwmin=15, cwmax=1023 aifs=7
uap0: interface state COUNTRY_UPDATE->ENABLED
uap0: AP-ENABLED
uap0: STA e4:a7:a0:4a:c7:3e IEEE 802.11: associated ← Connection from client (station)
uap0: AP-STA-CONNECTED e4:a7:a0:4a:c7:3e
uap0: STA e4:a7:a0:4a:c7:3e RADIUS: starting accounting session 00000041-00000000
uap0: STA e4:a7:a0:4a:c7:3e WPA: pairwise key handshake completed (RSN)
```

5. Manufacturing utility (MFG)

*Please restart ESPRESSObin before MFG operation.

5.1 Wired network settings



Windows PC
192.168.1.100



```
root@localhost:~# ifconfig eth0 up
root@localhost:~# ifconfig lan0 192.168.1.10 up
You can set the IP address arbitrarily.
```

5.2 Load WLAN and Bluetooth driver with MFG firmware

```
root@localhost:~# cd /home/8887/bin_sd8887
root@localhost:/home/8887/bin_sd8887# insmod mlan.ko
root@localhost:/home/8887/bin_sd8887#
insmod sd8887.ko cal_data_cfg=none mfg_mode=1 fw_name=mrvl/sdio8887_sdio_combo.bin
[ 127.544784] wlan: Loading MWLAN driver
[ 127.552974] wlan: Driver loaded successfully
root@localhost:/home/8887/bin_sd8887# cd ../bin_sd8887_bt/
root@localhost:/home/8887/bin_sd8887_bt# insmod bt8887.ko
[ 287.204131] BT: Loading driver
[ 287.207515] BT: Driver loaded successfully
```

Turn on the power of the evaluation board and insert it into SDIO of ESPRESSObin.

```
root@localhost:/home/8887/bin_sd8887_bt#
[ 328.904607] vendor=0x02DF device=0x9135 class=0 function=1
[ 328.912467] SDIO: max_segs=128 max_seg_size=65536
[ 328.917119] rx_work=1 cpu_num=2
[ 328.925621] Request firmware: mrvl/sdio8887_sdio_combo.bin
[ 329.963455] WLAN FW is active
[ 329.985829] IOCTL failed: fffffc038154800 id=0x20000, sub_id=0x20006 action=1, status_code=0x2
[ 329.994793] set mac address failed! status=-1, error_code=0x2
[ 330.011301] wlan: version = SD8887-0.0.0.p0-C4X15C605-GPL-(FP68)
[ 330.021305] ahci-mvebu d00e0000.sata: couldn't get PHY in node sata: -517
[ 330.030038] orion-ehci d005e000.usb: init d005e000.usb fail, -517
[ 330.053699] ahci-mvebu d00e0000.sata: couldn't get PHY in node sata: -517
[ 330.069738] orion-ehci d005e000.usb: init d005e000.usb fail, -517
```

5.3 Run “MFG Bridge” application

```
root@localhost:/home/8887/bin_sd8887_bt# cd ../bin_mfgbridge/  
root@localhost:/home/8887/bin_mfgbridge# ./mfgbridge  
UART: initialize ...  
Can't get port settings: Input/output error  
NET: initialize ...  
NET: socket bind is completed!  
NET: initialization is completed.  
NET: server port: 9930  
NET: client port: 9931
```

Execute "DutApi_w8887_BrdigeEth.exe" on the Windows PC side.
 (Please refer to "8887_MFG_Bridge_User_Guide" for details. It can be download from the following.
<https://www.yuden.co.jp/ut/product/category/module/lineup.html#WLAN>)

```

NET: new connection from 192.168.1.100
Initialize drvwrapper ....
no nfc /dev/mnfcchar0no nfc /dev/mfmchar0Initialize drvwrapper for BT ....
DRV: driver is initialized.
NET: socket FD = 5
NET: receive a packet (bytes = 40
BRDG: process Rx msg ...
NET: WLAN command.
DRV: send host cmd thr ioctl
DRV: host cmd is completed
NET: send a msg.
NET: the msg is sent.
NET: socket FD = 5
NET: receive a packet (bytes = 36
BRDG: process Rx msg ...
NET: WLAN command.
DRV: send host cmd thr ioctl
DRV: host cmd is completed
NET: send a msg.
NET: the msg is sent.
NET: socket FD = 5
NET: receive a packet (bytes = 0
NET: close client socket
De-Initialize drvwrapper for BT...
De-Initialize drvwrapper ....
NET: socket FD = 4
NET: new connection from 192.168.1.100
Initialize drvwrapper ....
no nfc /dev/mnfcchar0no nfc /dev/mfmchar0Initialize drvwrapper for BT ....
DRV: driver is initialized.
NET: socket FD = 5
NET: receive a packet (bytes = 16
BRDG: process Rx msg ...
HCI Command
Rx Event E for 09 10
In Cmd 09 10
NET: send a msg.
NET: the msg is sent.
    
```

```

Name:      Dut labtool
Version:   2.0.0.96
Date:      May 2 2017 (11:53:53)

Note:
1. =====WiFi tool=====
2. =====BT tool=====
3. =====FM tool=====
4. =====NFC tool=====

Enter CMD 99 to Exit
Enter option: 1
    
```

```

Enter option: 1
Name:      DutApiClass
Interface: EtherNet
Version:   2.0.0.96
Date:      May 2 2017 (11:53:34)

Note:
C:\Users\j\Documents\Downloads\ESPRESSO\bin\MFG-W8887-MF-WIFI-BT-FM-BRG-FC-WIN-X86-2.0.0.96-15.2.7.p123\bin\release
\setup.ini
Dut's IP 192.168.1.10:9930
Host's IP 192.168.1.100:9931
DutIf_UdpIp::delay 0
DutIf_UdpIp::vg_IfSpy 0
TCP connecting...
DutIf_InitConnection: 0

-----
W87xx (802.11a/g/b/n/ac) TEST MENU
-----
Enter option:
    
```

```

-----
W87xx (802.11a/g/b/n/ac) TEST MENU
-----
Enter option: 45
DutIf_GetMACAddress: 0x00000000
DutIf_GetMACAddress: ac.3f.a4.84.d1.88
Enter option:
    
```

```

Enter option: 99
Exiting
DutIf_Disconnection: 0
1. =====WiFi tool=====
2. =====BT tool=====
3. =====FM tool=====
4. =====NFC tool=====

Enter CMD 99 to Exit

Enter option: 2
Name:      DutApiClass
Interface: Version: 2.0.0.96
Date:      May 2 2017 (11:53:36)

Note:
C:\Users\j\Documents\Downloads\ESPRESSO\bin\MFG-W8887-MF-WIFI-BT-FM-BRG-FC-WIN-X86-2.0.0.
\setup.ini
Dut's IP 192.168.1.10:9930
Host's IP 192.168.1.100:9931
DutIf_UdpIp::delay 0
DutIf_UdpIp::vg_IfSpy 0
TCP connecting...
Dut_Bt_OpenDevice: 0x00000000

-----
W87xx (BT) TEST MENU
-----
Enter option: 45
45
Dut_Bt_GetBDAddress: 0x00000000
BD_ADDRESS: AC-3F-A4-84-D1-89
Enter option:
    
```

6. About SDIO switching

This is the setting of SDIO bus speed switching on each evaluation board.

CN3: VIO_SD Voltage Select

No.	Pin name	Direction	Description
1	3.3V	Output	3.3V output. (high speed)
2	VIO	Input	Input for VIO_SD.
3	1.8V	Output	1.8V output. (ultra-high speed)

Setting: 1-2 short -> high speed

Setting: 2-3 short -> ultra-high speed

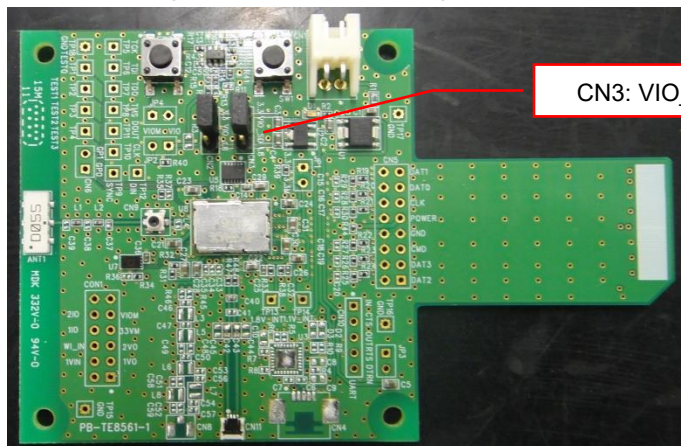

CN3: VIO_SD

WBSBHVXG

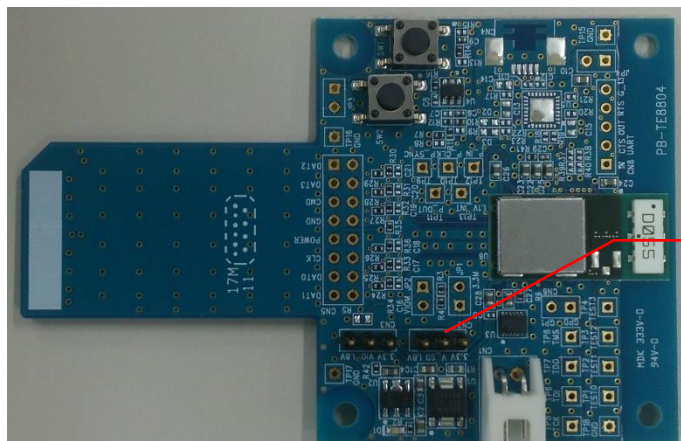

CN2: VIO_SD

WBSAGVDXG

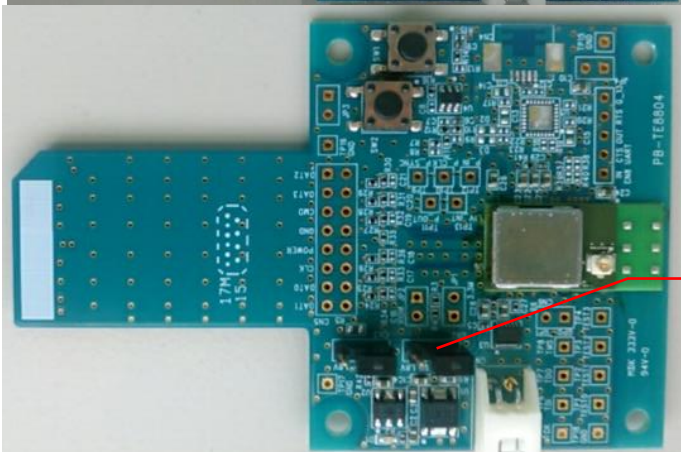

CN2: VIO_SD

WBSEGVDXG