

Extremely Thin Relays Integrated with Heat Sinks

- Downsizing achieved through optimum design of heat sink.
 - Mounting possible via screws or via DIN track.
 - Close mounting possible for linking terminals. (Except for G3PA-260B-VD and G3PA-450B-VD-2.)
 - Applicable with 3-phase loads.
 - Replaceable power element cartridges.
 - Comply with VDE 0160 (finger protection), with a dielectric strength of 4,000 V between input and load.
 - Certified by UL, CSA, and VDE (reinforced insulation). *
- * Only UL and CSA certification applies to model numbers that end in -VD-X.



* Not applicable to model numbers that end in -VD-X.



Note: Manufacture of the following models will be discontinued at the end of March 2017: G3PA-210B-VD, G3PA-220B-VD, G32A-A10-VD, and G32A-A20VD.

For the most recent information on models that have been certified for safety standards, refer to your OMRON website.

 Refer to *Safety Precautions for All Solid State Relays*.

Model Number Structure

Model Number Legend

G3PA-□□□□-□-□
 1 2 3 4 5 6 7

- 1. Basic Model Name**
G3PA: Solid State Relay
- 2. Rated Load Power Supply Voltage**
2: 200 VAC
4: 400 VAC
- 3. Rated Load Current**
10: 10 A
20: 20 A
30: 30 A
40: 40 A
50: 50 A
60: 60 A
- 4. Terminal Type**
B: Screw terminals
- 5. Zero Cross Function**
Blank: Equipped with zero cross function
L: Not equipped with zero cross function
- 6. Certification**
VD: Certified by UL, CSA, and VDE
- 7. Special Specifications**
Blank: Standard models
2: 480-V models
X: Non-compliant of EN standard (CE mark)

Ordering Information

■ List of Models

Model	Isolation	Zero cross function	Indicator	Rated output load	Rated input voltage	
G3PA-210B-VD-X	Phototriac coupler	Yes	Yes	10 A at 24 to 240 VAC	5 to 24 VDC	
G3PA-210B-VD *				20 A at 24 to 240 VAC		
G3PA-220B-VD-X				40 A at 24 to 240 VAC		
G3PA-220B-VD *				60 A at 24 to 240 VAC		
G3PA-240B-VD				10 A at 24 to 240 VAC		
G3PA-260B-VD				20 A at 24 to 240 VAC		
G3PA-210BL-VD		No		40 A at 24 to 240 VAC		
G3PA-220BL-VD				60 A at 24 to 240 VAC		
G3PA-240BL-VD				10 A at 24 to 240 VAC		
G3PA-260BL-VD				20 A at 24 to 240 VAC		
G3PA-210B-VD		Yes		Yes	40 A at 24 to 240 VAC	24 VAC
G3PA-220B-VD					60 A at 24 to 240 VAC	
G3PA-240B-VD					10 A at 24 to 240 VAC	
G3PA-260B-VD					20 A at 24 to 240 VAC	
G3PA-420B-VD					40 A at 24 to 240 VAC	12 to 24 VDC
G3PA-430B-VD					60 A at 24 to 240 VAC	
G3PA-420B-VD-2	20 A at 180 to 400 VAC					
G3PA-430B-VD-2	30 A at 180 to 400 VAC					
G3PA-450B-VD-2	20 A at 200 to 480 VAC	30 A at 200 to 480 VAC				
	50 A at 200 to 480 VAC					

Note: When ordering, specify the rated input voltage.

* Manufacture will be discontinued at the end of March 2017.

Replacement Parts

Name	Carry current	Load voltage range	Model	Applicable SSR	VDE certification		
Power Device Cartridge	10 A	19 to 264 VAC	G32A-A10-VD-X DC5-24	G3PA-210B-VD DC5-24 G3PA-210B-VD-X DC5-24	No		
			G32A-A10-VD DC5-24 *	G3PA-210B-VD DC5-24	Yes		
			G32A-A10L-VD DC5-24	G3PA-210BL-VD DC5-24	No		
			G32A-A10-VD AC24	G3PA-210B-VD AC24			
			20 A	G32A-A20-VD-X DC5-24	G3PA-220B-VD DC5-24 G3PA-220B-VD-X DC5-24	No	
				G32A-A20-VD DC5-24 *	G3PA-220B-VD DC5-24	Yes	
	G32A-A20L-VD DC5-24			G3PA-220BL-VD DC5-24			
	G32A-A20-VD AC24			G3PA-220B-VD AC24			
	40 A			G32A-A40-VD DC5-24	G3PA-240B-VD DC5-24		No
				G32A-A40L-VD DC5-24	G3PA-240BL-VD DC5-24		
			G32A-A40-VD AC24	G3PA-240B-VD AC24			
			60 A	G32A-A60-VD DC5-24	G3PA-260B-VD DC5-24	Yes	
				G32A-A60L-VD DC5-24	G3PA-260BL-VD DC5-24		
				G32A-A60-VD AC24	G3PA-260B-VD AC24		
	20 A			150 to 440 VAC	G32A-A420-VD DC12-24		G3PA-420B-VD DC12-24
					G32A-A430-VD DC12-24		G3PA-430B-VD DC12-24
					30 A		180 to 528 VAC
	G32A-A430-VD-2 DC12-24		G3PA-430B-VD-2 DC12-24				
50 A	G32A-A450-VD-2 DC12-24	G3PA-450B-VD-2 DC12-24					

* Manufacture will be discontinued at the end of March 2017.

■ Other Units (Order Separately)

Units that Enable 2-line Switching of 3-phase Power

Name	Current flow	Model	Applicable SSR
Short-circuit Unit	10 A	G32A-D20	G3PA-210B-VD-X, G3PA-210BL-VD
	20 A		G3PA-220B-VD-X, G3PA-220BL-VD G3PA-420B-VD, G3PA-420B-VD-2
	30 A	G32A-D40	G3PA-430B-VD, G3PA-430B-VD-2
	40 A		G3PA-240B-VD, G3PA-240BL-VD

Note: Refer to *List of Certified Models* for a list of products that comply with safety standards.

Specifications

■ Ratings (at an Ambient Temperature of 25°C)

Input

Model	Rated voltage	Operating Voltage range	Input current impedance	Voltage level	
				Must operate voltage	Must release voltage
G3PA-210B-VD-X	5 to 24 VDC	4 to 30 VDC	7 mA max.	4 VDC max.	1 VDC min.
G3PA-220B-VD-X					
G3PA-240B-VD					
G3PA-260B-VD					
G3PA-210BL-VD	5 to 24 VDC	4 to 30 VDC	20 mA max.	4 VDC max.	1 VDC min.
G3PA-220BL-VD					
G3PA-240BL-VD					
G3PA-260BL-VD					
G3PA-210B-VD	24 VAC	19.2 to 26.4 VAC	1.4 kΩ±20%	19.2 VAC max.	4.8 VAC min.
G3PA-220B-VD					
G3PA-240B-VD					
G3PA-260B-VD					
G3PA-420B-VD	12 to 24 VDC	9.6 to 30 VDC	7 mA max.	9.2 VDC max.	1 VDC min.
G3PA-430B-VD					
G3PA-420B-VD-2					
G3PA-430B-VD-2					
G3PA-450B-VD-2					

Output

Model	Rated load voltage	Load voltage range	Load current	Inrush current	V _{DRM} (reference value)
G3PA-210B(L)-VD(-X)	24 to 240 VAC (50/60 Hz)	19 to 264 VAC (50/60 Hz)	0.1 to 10 A at 40°C	150 A (60 Hz, 1 cycle)	600 V (V _{DRM})
G3PA-220B(L)-VD(-X)			0.1 to 20 A at 40°C	220 A (60 Hz, 1 cycle)	
G3PA-240B(L)-VD			0.5 to 40 A at 40°C	440 A (60 Hz, 1 cycle)	
G3PA-260B(L)-VD			0.5 to 60 A at 40°C	440 A (60 Hz, 1 cycle)	
G3PA-420B-VD	180 to 400 VAC (50/60 Hz)	150 to 440 VAC (50/60 Hz)	0.5 to 20 A at 30°C	220 A (60 Hz, 1 cycle)	1,000 V (V _{DRM})
G3PA-430B-VD			0.5 to 30 A at 30°C	440 A (60 Hz, 1 cycle)	
G3PA-420B-VD-2	200 to 480 VAC (50/60 Hz)	180 to 528 VAC (50/60 Hz)	0.5 to 20 A at 30°C	220 A (60 Hz, 1 cycle)	1,200 V (V _{DRM})
G3PA-430B-VD-2			0.5 to 30 A at 30°C	440 A (60 Hz, 1 cycle)	
G3PA-450B-VD-2			0.5 to 50 A at 30°C	440 A (60 Hz, 1 cycle)	

Refer to *Engineering Data* for further details.

■ Characteristics

Item	G3PA-210B(L)-VD(-X)	G3PA-220B(L)-VD(-X)	G3PA-240B(L)-VD	G3PA-260B(L)-VD	G3PA-420B-VD	G3PA-420B-VD-2	G3PA-430B-VD	G3PA-430B-VD-2	G3PA-450B-VD-2	
Operate time	1/2 of load power source cycle + 1 ms max. (DC Input, -B models) 1 1/2 of load power source cycle + 1 ms max. (AC Input) 1 ms max. (-BL models)									
Release time	1/2 of load power source cycle + 1 ms max. (DC Input) 1 1/2 of load power source cycle + 1 ms max. (AC Input)									
Output ON voltage drop	1.6 V (RMS) max.					1.8 V (RMS) max.				
Leakage current	5 mA max. (at 100 VAC) 10 mA max. (at 200 VAC)		10 mA max. (at 100 VAC) 20 mA max. (at 200 VAC)		20 mA max. (at 400 VAC)	20 mA max. (at 480 VAC)	20 mA max. (at 400 VAC)	20 mA max. (at 480 VAC)		
I ² t	260 A ² s		1,260 A ² s		260 A ² s	1,800 A ² s	1,800 A ² s		1,800 A ² s	
Insulation resistance	100 MΩ min. (at 500 VDC)									
Dielectric strength	4,000 VAC, 50/60 Hz for 1 min									
Vibration resistance	Destruction: 10 to 55 to 10 Hz, 0.375-mm single amplitude (Mounted to DIN track)									
Shock resistance	Destruction: 300 m/s ² (mounted to DIN track)									
Ambient temperature	Operating: -30°C to 80°C (with no icing or condensation) Storage: -30°C to 100°C (with no icing or condensation)									
Certified standards	UL508, CSA C22.2 (No.14, No.950), EN60950-1 File No. 5915ÜG				UL508, CSA C22.2 (No.14), EN60947-4-3 File No. 6642ÜG	UL508, CSA C22.2 (No.14), EN60947-4-3 File No. 133127ÜG	UL508, CSA C22.2 (No.14), EN60947-4-3 File No. 6642ÜG	UL508, CSA C22.2 (No.14), EN60947-4-3 File No. 133127ÜG		
EMC	Emission: EN55011 Group 1 Class A Immunity: EN61000-6-2									
Ambient humidity	Operating: 45% to 85%									
Weight	Approx. 260 g	Approx. 340 g	Approx. 460 g	Approx. 900 g	Approx. 290 g	Approx. 290 g	Approx. 410 g	Approx. 410 g	Approx. 900 g	

Operation

■ Replacement Parts

G32A-A Power Device Cartridge

The G32A-A Power Device Cartridge (a Triac Unit) can be replaced with a new one. When the temperature indicator has changed from pink to red, the triac circuitry may have malfunctioned possibly by an excessive flow of current, in which case, dismantle the damaged cartridge for replacement.

The damaged cartridge can be replaced with a new one without disconnecting the wires from the G3PA.

Improve the heat radiation efficiency of the G3PA before replacing the cartridge.

The G32A-A Power Device Cartridge can withstand an excessive current for a short period of time, such as may be caused accidentally by the short circuitry of the load, in which case the temperature indicator will not turn red.

Be sure to turn OFF the power supply when replacing the Cartridge. Supplying power with the Cartridge removed may result in malfunction.

To remove or replace the Power Device Cartridge for the G3PA-210B(L)-VD(-X), G3PA-220B(L)-VD(-X), or G3PA-420B-VD(-2), use the special tool provided with it for extraction. (No special tool is required for other models.)

The G3PA can be broadly divided into two series: Previous models and models with model numbers that end with "-VD." The Cartridge shown at the right cannot be mounted to models in the G3PA-□□□B(-US) Series.

Appearance

G32A-A10(L)-VD(-X)

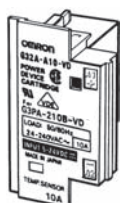

G32A-A20(L)-VD(-X)

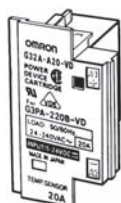

G32A-A40(L)-VD

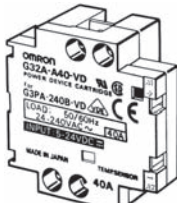

G32A-A60(L)-VD

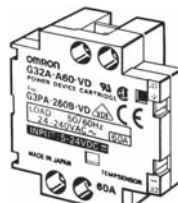

G32A-A420-VD(-2)

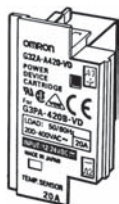

G32A-A430-VD(-2)

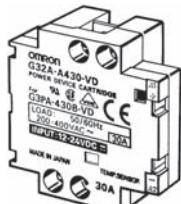

G32A-A450-VD-2

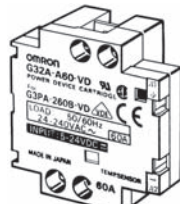

Replacing Power Device Cartridges

When replacing Power Device Cartridges, use the specified model. Using a Power Device Cartridge other than the specified one will result in faulty operation and destruction of the elements.

■ Replacement Procedure

G32A-A10(L)-VD(-X)/G32A-A20(L)-VD(-X)/G32-A420-VD(-2)

To remove or replace the Power Device Cartridge, use the special tool provided with it for extraction.
(Do not switch on the power without the Power Device Cartridge. For details, see the attached the instruction sheet with the product.)

Extraction

Follow the procedures below to dismantle the Power Device Cartridge from the G3PA.

1. Switch off the power.
2. Remove the terminal cover.
3. Hook the indented part of the cartridge with the tool and pull up on the cartridge to remove it.

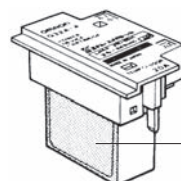
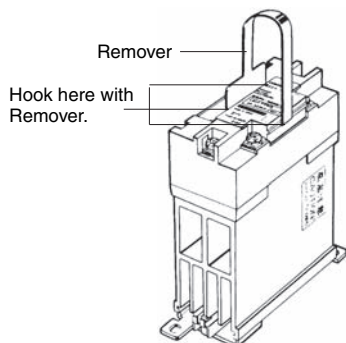

2. Make sure that there is no dust or pieces of wire on the heat sink of the G32A-A or the G3PA.
3. Insert the cartridge into the opening of the G3PA so that the letters on the cartridge and those on the G3PA are in the same direction and side A and side B are even.

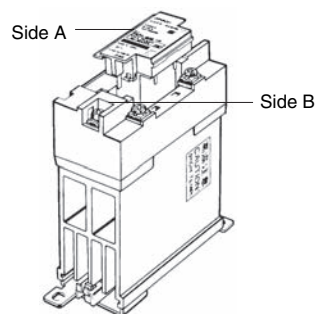

Mounting

Follow the procedures below to mount the Power Device Cartridge on the G3PA.

1. Apply silicone grease (provided with the G32A-A) to the entire surface of the heat sink.
4. Attach the terminal cover.
5. Switch on the power and check the G3PA to be sure it works properly.

G32A-A40(L)-VD/G32A-A60(L)-VD/G32A-A430-VD(-2)/G32A-A450-VD-2

The G32A Power Device Cartridge is mounted and secured with screws to the G3PA Unit. No special tool is required to remove the Cartridge.

Extraction

Follow the procedures below to dismantle the G32A-A Power Device Cartridge from the G3PA.

1. Switch off the power.
2. Remove the terminal cover.
3. Loosen the two centered screws on the sides to dismantle the cartridge. The screws are connected to terminals 1 and 2.

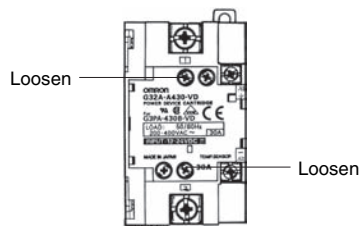

4. Loosen the screws on both the corners.

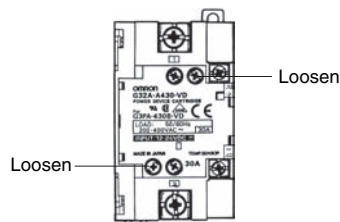

5. Hold the indented part of both the corners to dismantle the cartridge.

Mounting

1. Apply silicone grease to the entire surface of the heat sink.

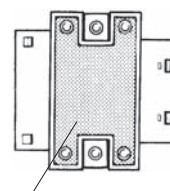

2. Make sure that there is no dust or pieces of wire on the heat sink of the G32A-A or the G3PA.

3. Insert the cartridge into the opening of the G3PA so that side A and side B are even.

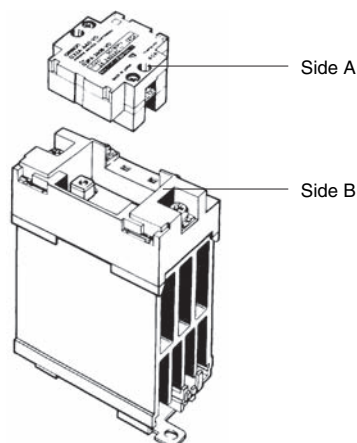

4. Tighten the screws on both the corners with a tightening torque of 0.59 to 0.78 N·m.
5. Tighten the screws on both the sides with a tightening torque of 0.59 to 0.78 N·m.
6. Attach the terminal cover.
7. Switch on the power and check the G3PA to be sure it works properly.

■ Linking Terminal Connection

- Connecting with linking terminal for G3PA-210B(L)-VD(-X), -220B(L)-VD(-X), -240B(L)-VD and G3PA-420B-VD(-2), G3PA-430B-VD(-2).

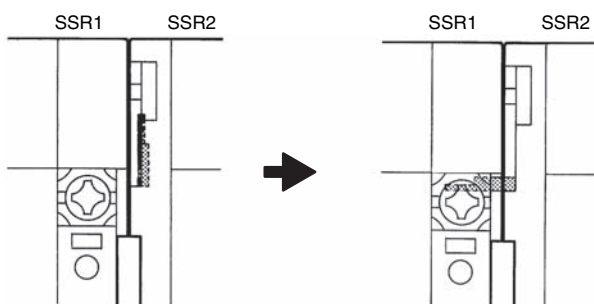

1. When SSRs are close mounted, loosen the M3.5 Sems screw and flip the linking terminal down.

2. Insert the linking terminal securely into the center of the screw and tighten the screw.

- Connecting with linking terminal for G32A.

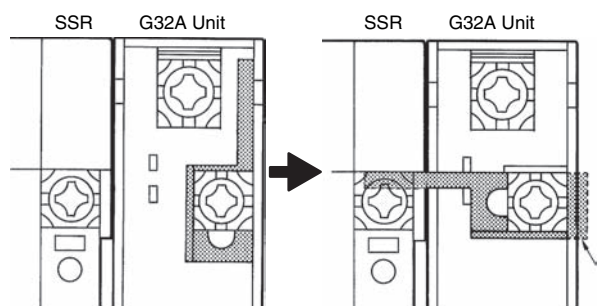

* The cover will not fit if the terminal protrudes.

1. When SSR are close mounted, loosen the M3.5 Sems screw on the G32A and flip the linking terminal down.

2. Insert the linking terminal securely into the center of the screw and tighten the screw. Ensure that the linking terminal does not protrude.

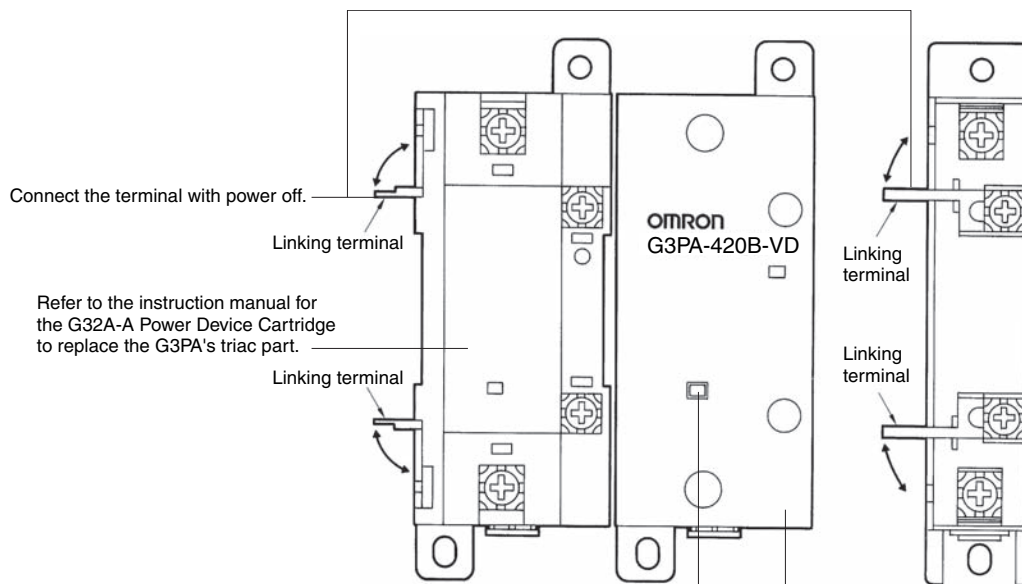

When the temperature indicator has turned from pink to red, the G32A-A Power Device Cartridge may have malfunctioned, in which case the cartridge must be replaced with a new one.

Use the terminal cover to prevent accidents due to electric shock.

Engineering Data

Load Current vs. Ambient Temperature

Vertical Mounting

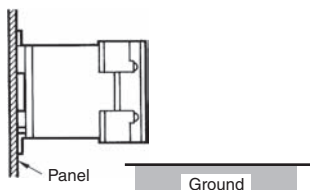

**G3PA-210B(L)-VD(-X),
G3PA-220B(L)-VD(-X)**

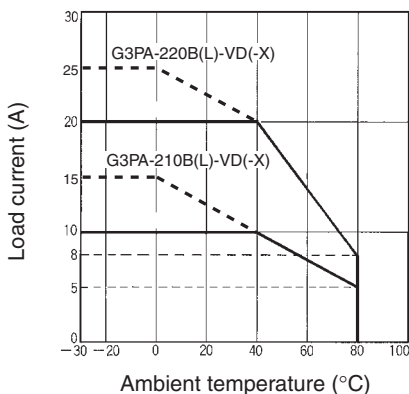

G3PA-240B(L)-VD

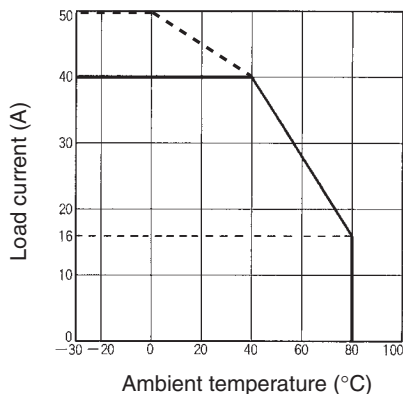

G3PA-260B(L)-VD

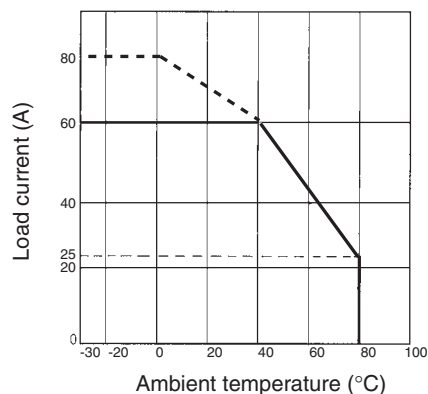

For close mounting of two or three SSRs, limit the load current to 90% or less.

G3PA-420B-VD, G3PA-420B-VD-2

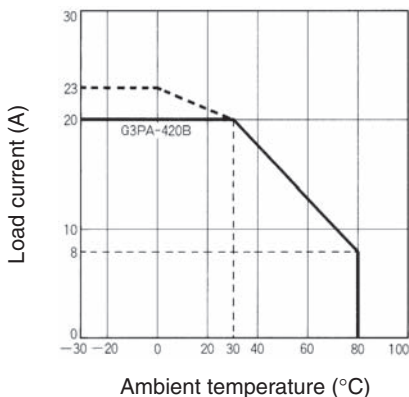

G3PA-430B-VD, G3PA-430B-VD-2

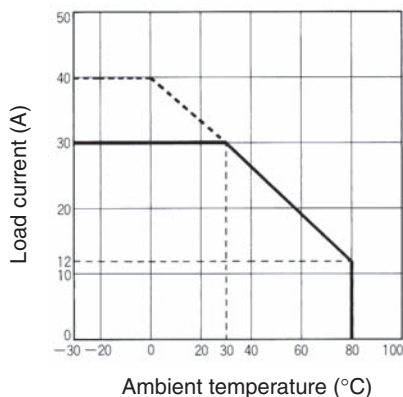

G3PA-450B-VD-2

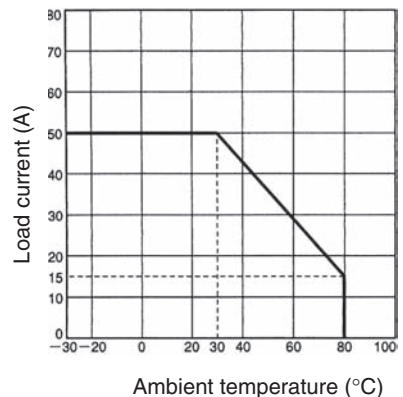

For close mounting of two or three SSRs, limit the load current to 80% or less.

Input Voltage vs. Input Current

G3PA-2□0B-VD(-X)

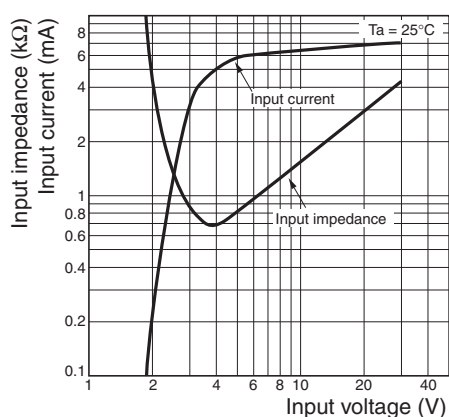

G3PA-4□0-VD, G3PA-4□-VD-2

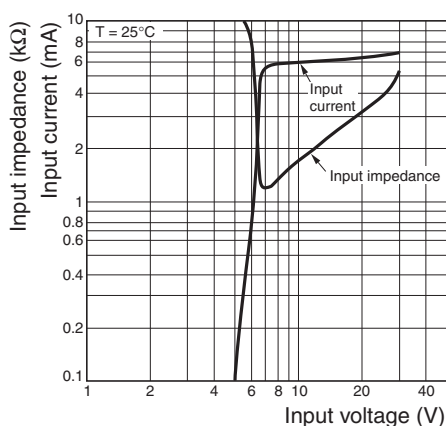

Horizontal Mounting

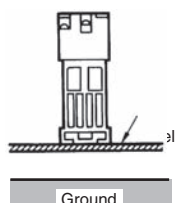

G3PA-210B(L)-VD(-X),
G3PA-220B(L)-VD(-X)

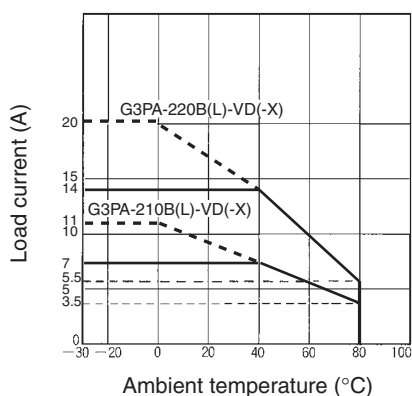

G3PA-240B(L)-VD

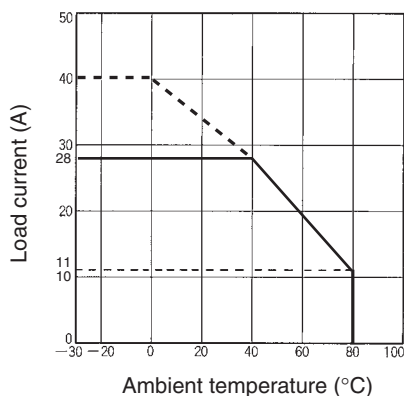

G3PA-260B(L)-VD

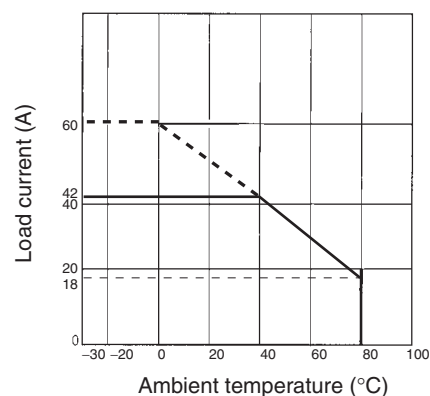

G3PA-420B-VD, G3PA-430B-VD
G3PA-420B-VD-2, G3PA-430B-VD-2

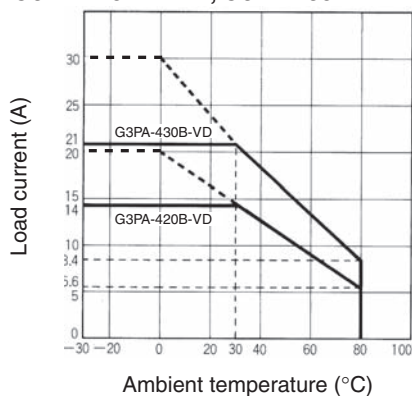

G3PA-450B-VD-2

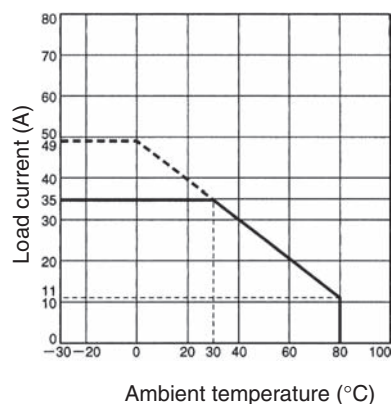

Close Mounting (Up to Three)

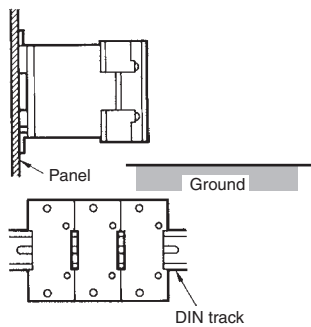

**G3PA-210B(L)-VD(-X),
G3PA-220B(L)-VD(-X)**

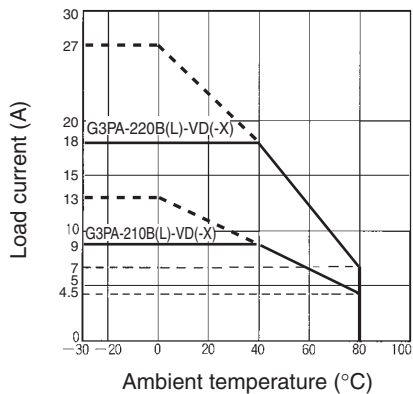

G3PA-240B(L)-VD

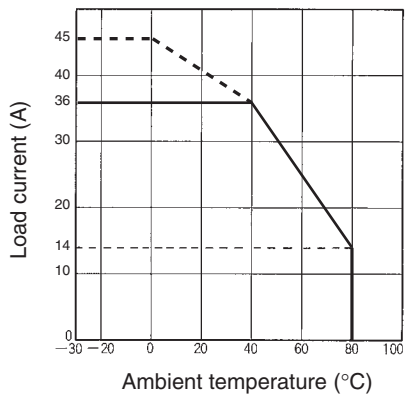

G3PA-260B(L)-VD

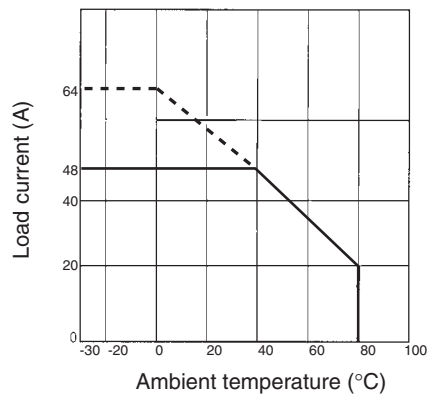

G3PA-420B-VD, G3PA-420B-VD-2

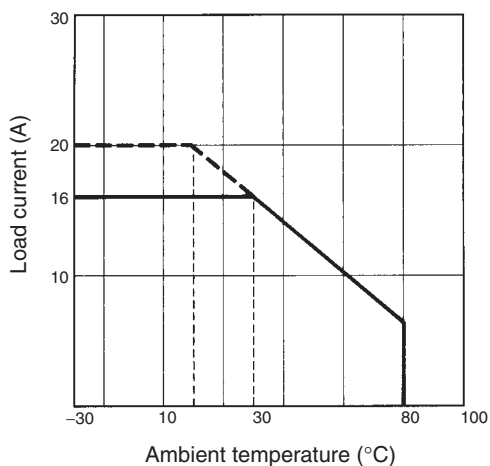

G3PA-430B-VD, G3PA-430B-VD-2

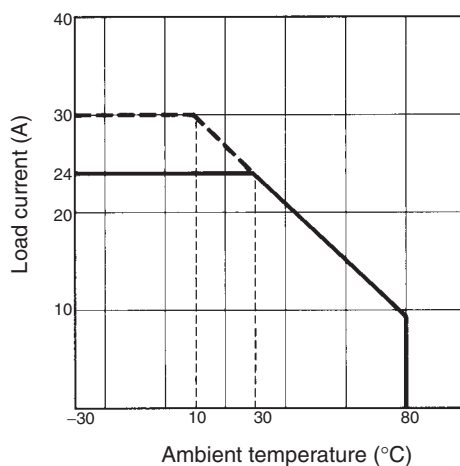

G3PA-450B-VD-2

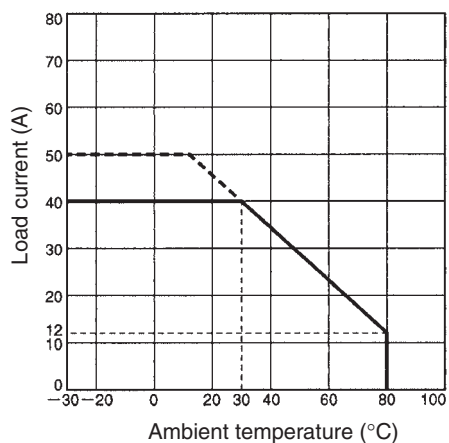

One Cycle Surge Current: Non-repetitive

Note: Keep the inrush current to half the rated value if it occurs repetitively.

G3PA-210B(L)-VD(-X)

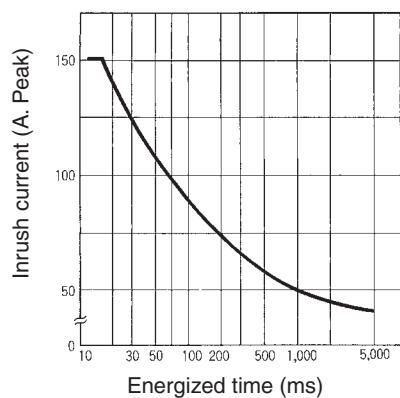

G3PA-220B(L)-VD(-X),
G3PA-420B-VD, G3PA-420B-VD-2

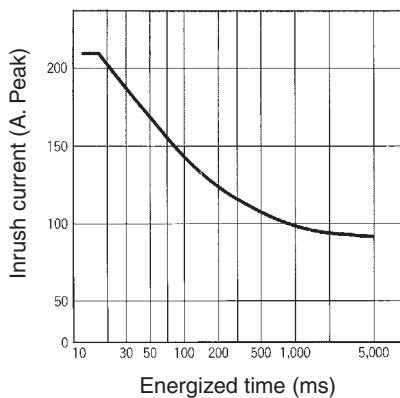

G3PA-240B(L)-VD/260B(L)-VD,
G3PA-430B-VD, G3PA-430B-VD-2,
G3PA-450B-VD-2

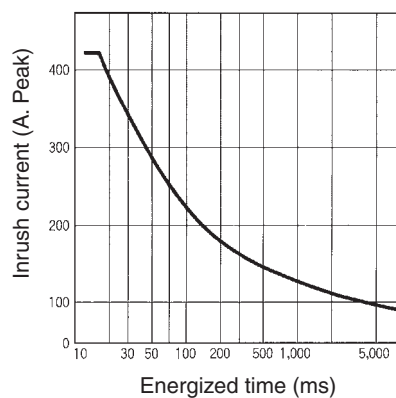

Dimensions

Note: All units are in millimeters unless otherwise indicated.

G3PA-210B(L)-VD(-X)

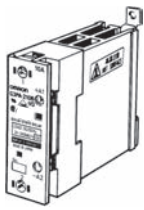

Without Terminal Cover

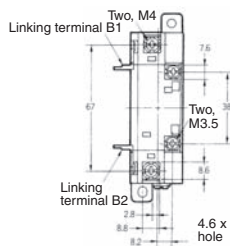

With Terminal Cover

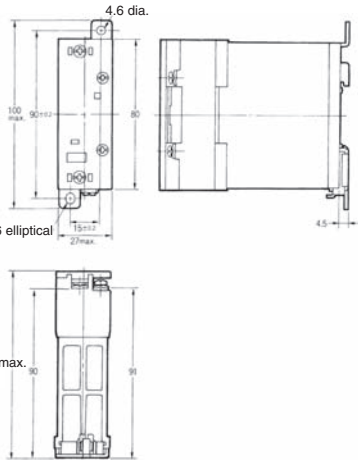

Mounting Holes

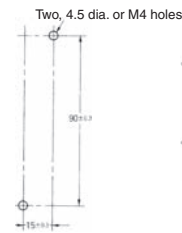

Terminal Arrangement/ Internal Connection:

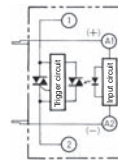

G3PA-220B(L)-VD(-X)

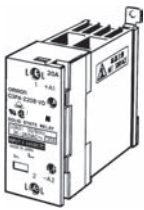

Without Terminal Cover

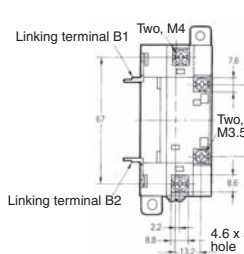

With Terminal Cover

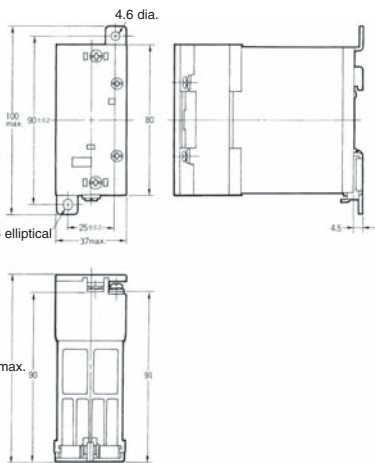

Mounting Holes

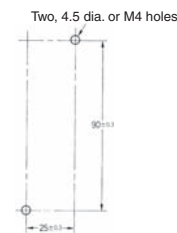

Terminal Arrangement/ Internal Connection:

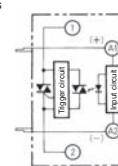

G3PA-240B(L)-VD

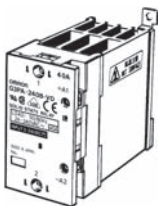

Without Terminal Cover

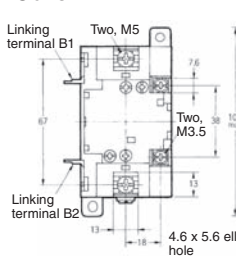

With Terminal Cover

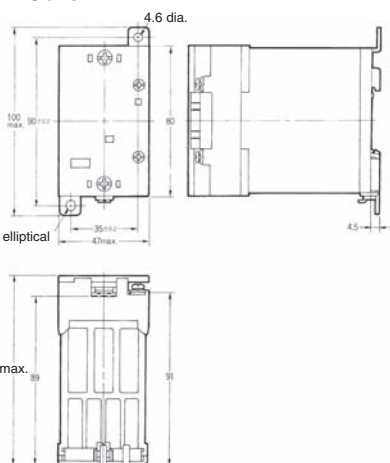

Mounting Holes

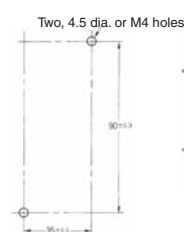

Terminal Arrangement/ Internal Connections

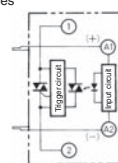

Safety Precautions

■ Precautions for Correct Use

Please observe the following precautions to prevent failure to operate, malfunction, or undesirable effect on product performance.

Load Connection

For an AC load, use a power supply rated at 50 or 60 Hz. The maximum operating frequency is 10 Hz. The G3PA-(VD) has a built-in varistor for overvoltage protection.

At a low applied voltage, such as 24 VAC, the load current is not fully supplied. When the Unit is switched ON, the voltage required to power the Unit deprives the output signal of the necessary voltage level and thus creates loss time. The lower the load voltage is, the greater the loss time is. This condition, however, will not create any serious problems.

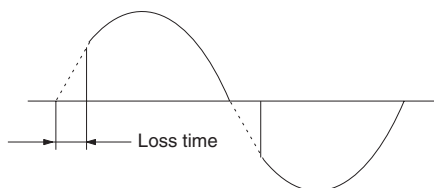

For a DC or L load, a diode should be connected in parallel the load to absorb the counter electromotive force of the load.

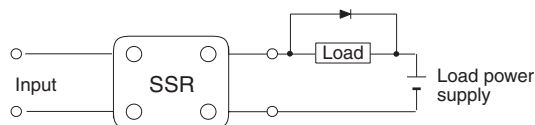

When attaching a heat sink to the G3PA-(VD), in order to facilitate heat dissipation, apply silicone grease or equivalent heat-conductive grease on the heat sink. (Toshiba Silicone, Shinetsu Silicone, etc.)

Tighten the mounting screws of the heat sink with a torque of 0.78 to 0.98 N·m.

Noise Terminal Voltage according to EN55011

The G3PA-(VD) complies with EN55011 standards when a capacitor is connected to the load power supply as shown in the following circuit diagram.

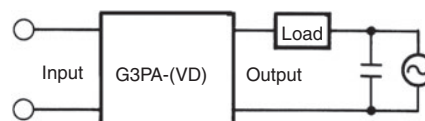

Recommended Capacitor: 1 μ F, 250 VAC

Mounting

The rated ambient temperature is 40°C. (30°C for 400 V.)

Vertical mounting

Close mounting

Horizontal mounting

- Screw or DIN track mounting is possible.
- Vertical mounting should usually be used.

- Close mounting cannot be used if the SSR is used at a 100% load current. Leave a gap of at least 10 mm on the left and right of each Unit.
- Close mounting can be used under the following conditions:
 1. Close mounting can be performed with no more than three SSRs (For four or more SSRs, leave a gap of at least 10 mm.)
 2. Use a load current of 80% or less (90% or less for the G3PA-210B-VD, G3PA-220B-VD, or G3PA-240B-VD).
 3. Leave a gap of at least 80 mm above and below the SSR.
 4. Leave a gap of at least 60 mm from wiring ducts to the top of the SSR and at least 30 mm from wiring ducts to the bottom of the SSR.

- With vertical mounting, reduce the load current by 30%. (Refer to the Load Current vs. Ambient Temperature graph.)

Note: Leave a distance of 60 mm min. between SSRs and ducts (especially above the SSR).

Close Mounting

SSR Mounting Pitch

Panel Mounting (At a rated ambient temperature of 40°C).

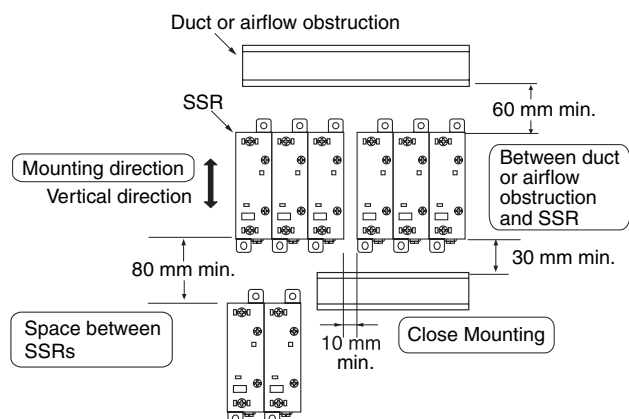

A heat exchanger, if used, should be located in front of the SSR Units to ensure the efficiency of the heat exchanger.

Please reduce the ambient temperature of SSRs.

The rated load current of an SSR is measured at an ambient temperature of 25 or 40 °C.

An SSR uses a semiconductor in the output element. This causes the temperature inside the control panel to increase due to heating resulting from the passage of electrical current through the load. To restrict heating, attach a fan to the ventilation outlet or air inlet of the control panel to ventilate the panel. This will reduce the ambient temperature of the SSRs and thus increase reliability. (Generally, each 10°C reduction in temperature will double the expected life.)

Load current (A)	10 A	20 A	30 A	40 A	60 A
Required number of fans per SSR	0.16	0.31	0.47	0.62	0.93

Example: For 10 SSRs with load currents of 20 A,
 $0.31 \times 10 = 3.1$
 Thus, 4 fans would be required.

Size of fans: 92 mm², Air volume: 0.7 m³/min,
 Ambient temperature of control panel: 30°C

Relationship between SSRs and Ducts

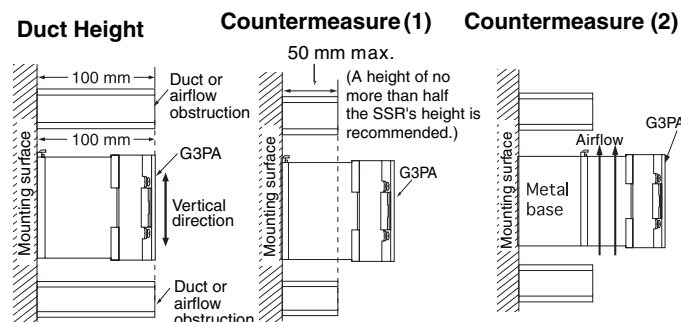

Do not surround the SSR with ducts, otherwise the heat radiation of the SSR will be adversely affected.

Use short ducts.

If the ducts cannot be shortened, place the SSR on a metal base so that it is not surrounded by the ducts.

If there are other instruments that generate heat in the control panel other than SSRs, additional ventilation will be required.

Ventilation

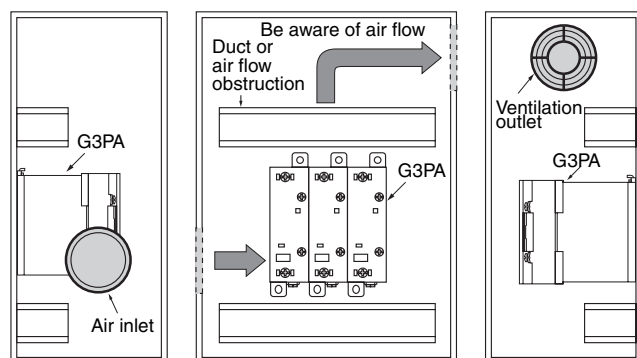

If the air inlet or air outlet has a filter, clean the filter regularly to prevent it from clogging and ensure an efficient flow of air.

Do not locate any objects around the air inlet or air outlet, otherwise the objects may obstruct the proper ventilation of the control panel.

ALL DIMENSIONS SHOWN ARE IN MILLIMETERS.
 To convert millimeters into inches, multiply by 0.03937. To convert grams into ounces, multiply by 0.03527.

In the interest of product improvement, specifications are subject to change without notice.

Terms and Conditions of Sale

1. **Offer; Acceptance.** These terms and conditions (these "**Terms**") are deemed part of all quotes, agreements, purchase orders, acknowledgments, price lists, catalogs, manuals, brochures and other documents, whether electronic or in writing, relating to the sale of products or services (collectively, the "**Products**") by Omron Electronics LLC and its subsidiary companies ("**Omron**"). Omron objects to any terms or conditions proposed in Buyer's purchase order or other documents which are inconsistent with, or in addition to, these Terms.
2. **Prices; Payment Terms.** All prices stated are current, subject to change without notice by Omron. Omron reserves the right to increase or decrease prices on any unshipped portions of outstanding orders. Payments for Products are due net 30 days unless otherwise stated in the invoice.
3. **Discounts.** Cash discounts, if any, will apply only on the net amount of invoices sent to Buyer after deducting transportation charges, taxes and duties, and will be allowed only if (i) the invoice is paid according to Omron's payment terms and (ii) Buyer has no past due amounts.
4. **Interest.** Omron, at its option, may charge Buyer 1-1/2% interest per month or the maximum legal rate, whichever is less, on any balance not paid within the stated terms.
5. **Orders.** Omron will accept no order less than \$200 net billing.
6. **Governmental Approvals.** Buyer shall be responsible for, and shall bear all costs involved in, obtaining any government approvals required for the importation or sale of the Products.
7. **Taxes.** All taxes, duties and other governmental charges (other than general real property and income taxes), including any interest or penalties thereon, imposed directly or indirectly on Omron or required to be collected directly or indirectly by Omron for the manufacture, production, sale, delivery, importation, consumption or use of the Products sold hereunder (including customs duties and sales, excise, use, turnover and license taxes) shall be charged to and remitted by Buyer to Omron.
8. **Financial.** If the financial position of Buyer at any time becomes unsatisfactory to Omron, Omron reserves the right to stop shipments or require satisfactory security or payment in advance. If Buyer fails to make payment or otherwise comply with these Terms or any related agreement, Omron may (without liability and in addition to other remedies) cancel any unshipped portion of Products sold hereunder and stop any Products in transit until Buyer pays all amounts, including amounts payable hereunder, whether or not then due, which are owing to it by Buyer. Buyer shall in any event remain liable for all unpaid accounts.
9. **Cancellation; Etc.** Orders are not subject to rescheduling or cancellation unless Buyer indemnifies Omron against all related costs or expenses.
10. **Force Majeure.** Omron shall not be liable for any delay or failure in delivery resulting from causes beyond its control, including earthquakes, fires, floods, strikes or other labor disputes, shortage of labor or materials, accidents to machinery, acts of sabotage, riots, delay in or lack of transportation or the requirements of any government authority.
11. **Shipping; Delivery.** Unless otherwise expressly agreed in writing by Omron:
 - a. Shipments shall be by a carrier selected by Omron; Omron will not drop ship except in "break down" situations.
 - b. Such carrier shall act as the agent of Buyer and delivery to such carrier shall constitute delivery to Buyer;
 - c. All sales and shipments of Products shall be FOB shipping point (unless otherwise stated in writing by Omron), at which point title and risk of loss shall pass from Omron to Buyer; provided that Omron shall retain a security interest in the Products until the full purchase price is paid;
 - d. Delivery and shipping dates are estimates only; and
 - e. Omron will package Products as it deems proper for protection against normal handling and extra charges apply to special conditions.
12. **Claims.** Any claim by Buyer against Omron for shortage or damage to the Products occurring before delivery to the carrier must be presented in writing to Omron within 30 days of receipt of shipment and include the original transportation bill signed by the carrier noting that the carrier received the Products from Omron in the condition claimed.
13. **Warranties.** (a) **Exclusive Warranty.** Omron's exclusive warranty is that the Products will be free from defects in materials and workmanship for a period of twelve months from the date of sale by Omron (or such other period expressed in writing by Omron). Omron disclaims all other warranties, express or implied. (b) **Limitations.** OMRON MAKES NO WARRANTY OR REPRESENTATION, EXPRESS OR IMPLIED, ABOUT NON-INFRINGEMENT, MERCHANTABILITY OR FITNESS FOR A PARTICULAR PURPOSE OF THE PRODUCTS. BUYER ACKNOWLEDGES THAT IT ALONE HAS DETERMINED THAT THE PRODUCTS WILL SUITABLY MEET THE REQUIREMENTS OF THEIR INTENDED USE. Omron further disclaims all warranties and responsibility of any type for claims or expenses based on infringement by the Products or otherwise of any intellectual property right. (c) **Buyer Remedy.** Omron's sole obligation hereunder shall be, at Omron's election, to (i) replace (in the form originally shipped with Buyer responsible for labor charges for removal or replacement thereof) the non-complying Product, (ii) repair the non-complying Product, or (iii) repay or credit Buyer an amount equal to the purchase price of the non-complying Product; provided that in no event shall Omron be responsible for warranty, repair, indemnity or any other claims or expenses regarding the Products unless Omron's analysis confirms that the Products were properly handled, stored, installed and maintained and not subject to contamination, abuse, misuse or inappropriate modification. Return of any Products by Buyer must be approved in writing by Omron before shipment. Omron Companies shall not be liable for the suitability or unsuitability or the results from the use of Products in combination with any electrical or electronic components, circuits, system assemblies or any other materials or substances or environments. Any advice, recommendations or information given orally or in writing, are not to be construed as an amendment or addition to the above warranty. See <http://www.omron247.com> or contact your Omron representative for published information.
14. **Limitation on Liability; Etc.** OMRON COMPANIES SHALL NOT BE LIABLE FOR SPECIAL, INDIRECT, INCIDENTAL, OR CONSEQUENTIAL DAMAGES, LOSS OF PROFITS OR PRODUCTION OR COMMERCIAL LOSS IN ANY WAY CONNECTED WITH THE PRODUCTS, WHETHER SUCH CLAIM IS BASED IN CONTRACT, WARRANTY, NEGLIGENCE OR STRICT LIABILITY. Further, in no event shall liability of Omron Companies exceed the individual price of the Product on which liability is asserted.
15. **Indemnities.** Buyer shall indemnify and hold harmless Omron Companies and their employees from and against all liabilities, losses, claims, costs and expenses (including attorney's fees and expenses) related to any claim, investigation, litigation or proceeding (whether or not Omron is a party) which arises or is alleged to arise from Buyer's acts or omissions under these Terms or in any way with respect to the Products. Without limiting the foregoing, Buyer (at its own expense) shall indemnify and hold harmless Omron and defend or settle any action brought against such Companies to the extent based on a claim that any Product made to Buyer specifications infringed intellectual property rights of another party.
16. **Property; Confidentiality.** Any intellectual property in the Products is the exclusive property of Omron Companies and Buyer shall not attempt to duplicate it in any way without the written permission of Omron. Notwithstanding any charges to Buyer for engineering or tooling, all engineering and tooling shall remain the exclusive property of Omron. All information and materials supplied by Omron to Buyer relating to the Products are confidential and proprietary, and Buyer shall limit distribution thereof to its trusted employees and strictly prevent disclosure to any third party.
17. **Export Controls.** Buyer shall comply with all applicable laws, regulations and licenses regarding (i) export of products or information; (ii) sale of products to "forbidden" or other proscribed persons; and (iii) disclosure to non-citizens of regulated technology or information.
18. **Miscellaneous.** (a) **Waiver.** No failure or delay by Omron in exercising any right and no course of dealing between Buyer and Omron shall operate as a waiver of rights by Omron. (b) **Assignment.** Buyer may not assign its rights hereunder without Omron's written consent. (c) **Law.** These Terms are governed by the law of the jurisdiction of the home office of the Omron company from which Buyer is purchasing the Products (without regard to conflict of law principles). (d) **Amendment.** These Terms constitute the entire agreement between Buyer and Omron relating to the Products, and no provision may be changed or waived unless in writing signed by the parties. (e) **Severability.** If any provision hereof is rendered ineffective or invalid, such provision shall not invalidate any other provision. (f) **Setoff.** Buyer shall have no right to set off any amounts against the amount owing in respect of this invoice. (g) **Definitions.** As used herein, "including" means "including without limitation"; and "Omron Companies" (or similar words) mean Omron Corporation and any direct or indirect subsidiary or affiliate thereof.

Certain Precautions on Specifications and Use

1. **Suitability of Use.** Omron Companies shall not be responsible for conformity with any standards, codes or regulations which apply to the combination of the Product in the Buyer's application or use of the Product. At Buyer's request, Omron will provide applicable third party certification documents identifying ratings and limitations of use which apply to the Product. This information by itself is not sufficient for a complete determination of the suitability of the Product in combination with the end product, machine, system, or other application or use. Buyer shall be solely responsible for determining appropriateness of the particular Product with respect to Buyer's application, product or system. Buyer shall take application responsibility in all cases but the following is a non-exhaustive list of applications for which particular attention must be given: (i) Outdoor use, uses involving potential chemical contamination or electrical interference, or conditions or uses not described in this document. (ii) Use in consumer products or any use in significant quantities. (iii) Energy control systems, combustion systems, railroad systems, aviation systems, medical equipment, amusement machines, vehicles, safety equipment, and installations subject to separate industry or government regulations. (iv) Systems, machines and equipment that could present a risk to life or property. Please know and observe all prohibitions of use applicable to this Product. NEVER USE THE PRODUCT FOR AN APPLICATION INVOLVING SERIOUS RISK TO LIFE OR PROPERTY OR IN LARGE QUANTITIES WITHOUT ENSURING THAT THE SYSTEM AS A WHOLE HAS BEEN DESIGNED TO ADDRESS THE RISKS, AND THAT THE OMRON'S PRODUCT IS PROPERLY RATED AND INSTALLED FOR THE INTENDED USE WITHIN THE OVERALL EQUIPMENT OR SYSTEM.
2. **Programmable Products.** Omron Companies shall not be responsible for the user's programming of a programmable Product, or any consequence thereof.
3. **Performance Data.** Data presented in Omron Company websites, catalogs and other materials is provided as a guide for the user in determining suitability and does not constitute a warranty. It may represent the result of Omron's test conditions, and the user must correlate it to actual application requirements. Actual performance is subject to the Omron's Warranty and Limitations of Liability.
4. **Change in Specifications.** Product specifications and accessories may be changed at any time based on improvements and other reasons. It is our practice to change part numbers when published ratings or features are changed, or when significant construction changes are made. However, some specifications of the Product may be changed without any notice. When in doubt, special part numbers may be assigned to fix or establish key specifications for your application. Please consult with your Omron's representative at any time to confirm actual specifications of purchased Product.
5. **Errors and Omissions.** Information presented by Omron Companies has been checked and is believed to be accurate; however, no responsibility is assumed for clerical, typographical or proofreading errors or omissions.

OMRON AUTOMATION AMERICAS HEADQUARTERS • Chicago, IL USA • 847.843.7900 • 800.556.6766 • www.omron247.com

OMRON CANADA, INC. • HEAD OFFICE

Toronto, ON, Canada • 416.286.6465 • 866.986.6766 • www.omron247.com

OMRON ELECTRONICS DE MEXICO • HEAD OFFICE

México DF • 52.55.59.01.43.00 • 01-800-226-6766 • mela@omron.com

OMRON ELECTRONICS DE MEXICO • SALES OFFICE

Apodaca, N.L. • 52.81.11.56.99.20 • 01-800-226-6766 • mela@omron.com

OMRON ELETRÔNICA DO BRASIL LTDA • HEAD OFFICE

São Paulo, SP, Brasil • 55.11.2101.6300 • www.omron.com.br

OMRON ARGENTINA • SALES OFFICE

Cono Sur • 54.11.4783.5300

OMRON CHILE • SALES OFFICE

Santiago • 56.9.9917.3920

OTHER OMRON LATIN AMERICA SALES

54.11.4783.5300

OMRON EUROPE B.V. • Wegalaan 67-69, NL-2132 JD, Hoofddorp, The Netherlands. • +31 (0) 23 568 13 00 • www.industrial.omron.eu

Authorized Distributor:

Controllers & I/O

- Machine Automation Controllers (MAC) • Motion Controllers
- Programmable Logic Controllers (PLC) • Temperature Controllers • Remote I/O

Robotics

- Industrial Robots • Mobile Robots

Operator Interfaces

- Human Machine Interface (HMI)

Motion & Drives

- Machine Automation Controllers (MAC) • Motion Controllers • Servo Systems
- Frequency Inverters

Vision, Measurement & Identification

- Vision Sensors & Systems • Measurement Sensors • Auto Identification Systems

Sensing

- Photoelectric Sensors • Fiber-Optic Sensors • Proximity Sensors
- Rotary Encoders • Ultrasonic Sensors

Safety

- Safety Light Curtains • Safety Laser Scanners • Programmable Safety Systems
- Safety Mats and Edges • Safety Door Switches • Emergency Stop Devices
- Safety Switches & Operator Controls • Safety Monitoring/Force-guided Relays

Control Components

- Power Supplies • Timers • Counters • Programmable Relays
- Digital Panel Meters • Monitoring Products

Switches & Relays

- Limit Switches • Pushbutton Switches • Electromechanical Relays
- Solid State Relays

Software

- Programming & Configuration • Runtime