

Revision Level			Revision Record	Changed	Date	Approved	Date
Drawing	State	Part					
00.2	Design Release	-	SEE ECN# 014774	TAT	12/3/2018	EJH	12/3/2018

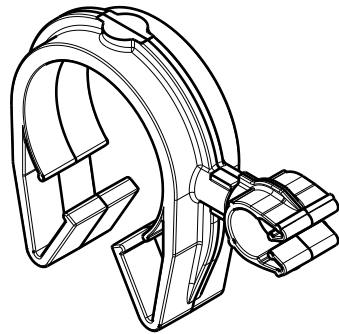

ISOMETRIC VIEW

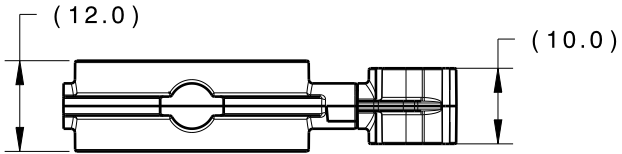
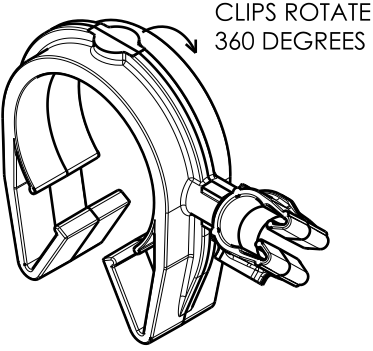
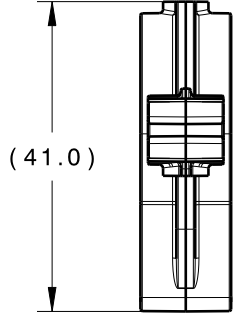
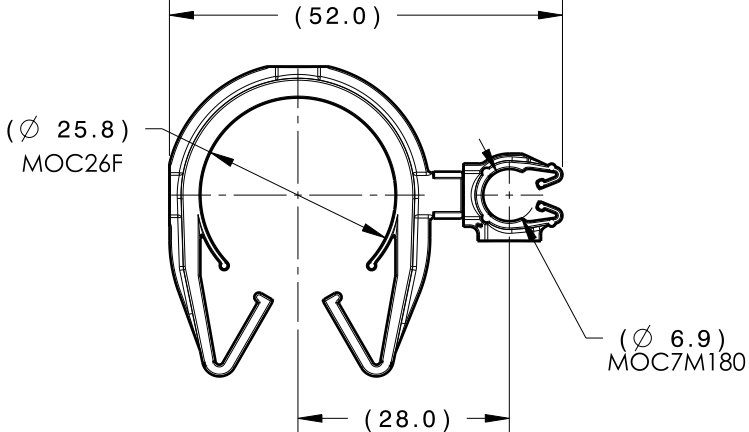

ISOMETRIC VIEW ROTATED

TYPE	MOC26F	MOC7M180
HARNESS	24.5MM - 28.5MM	6.5MM - 7.5MM
HOSE	23.0MM - 28.5MM	6.0MM - 7.5MM
HARD PIPE/TUBE	25.9MM - 29.0MM	7.0MM - 8.0MM

*RECOMMENDED SIZES MAY DIFFER DEPENDING ON THE APPLICATION , PRODUCT REQUIREMENTS AND MATERIALS USED

**PATENT PENDING 29/582,271

GLOBAL PART DESCRIPTION	MOC26F**			MOC7M180		
	DRAWING	MATERIAL	COLOR	DRAWING	MATERIAL	COLOR
MOC26FMOC7M180-PA66HIRHSUV-BK	16-0325-000-CSU	PA66HIRHSUV	BLACK	16-0315-000-CSU	PA66HIRHSUV	BLACK

Material SEE CHART COLOR: SEE CHART	Units	millimeters	The copyright of this drawing is reserved by HellermannTyton. It is issued on condition that it is not reproduced, copied or disclosed to a third party, either wholly or in part, without the consent of HellermannTyton.	Drawn	CJR	10/1/18	Article/Type-No	MOC26FMOC7M180		Scale	1:1
	Tolerance defined on each dimension	Approved		TAT	10/1/18	Title		26MM MOC COUPLED TO A 7MM MOC M180		Project Number	16-0330
		 North America Email: corp@htamericas.com Web: www.hellermann.tyton.com			Drawing-No		PRODUCTION : Phase		Format	AH	
							16-0330-824-CSU		Sheet	1/1	