

PTVA120252MT

Thermally-Enhanced High Power RF LDMOS FET
25 W, 48 V, 500 – 1400 MHz

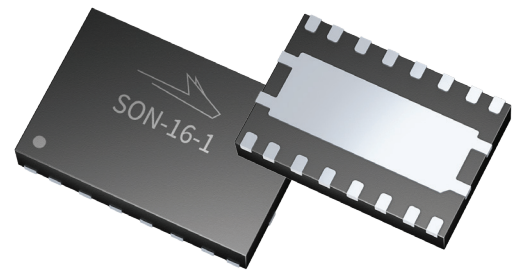

Description

The PTVA120252MT LDMOS FET is a 25-watt LDMOS FET designed for use in power amplifier applications in the 500 MHz to 1400 MHz frequency band. Features include high gain and a thermally-enhanced, surface-mount package. Manufactured with WolfSpeed’s advanced LDMOS process, this device provides excellent thermal performance and superior reliability.

Package Types: PG-SON-16

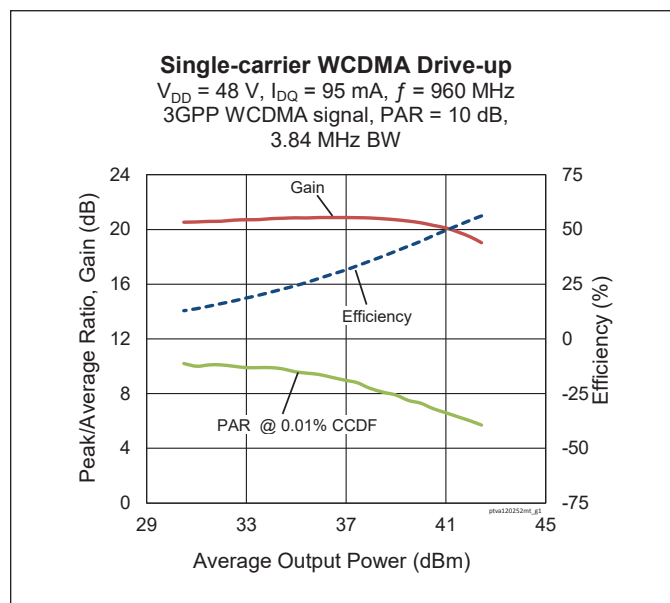

Features

- Unmatched
- Target CW performance 960 MHz, 48 V, combined outputs
 - Output power at $P_{1dB} = 25\text{ W}$
 - Gain = 19.8 dB
 - Efficiency = 64%
- Capable of handling 10:1 VSWR @ 48 V, 20 W CW output power
- Integrated ESD protection
- Human Body Model class 1C (per ANSI/ESDA/ JEDEC JS-001)
- Low thermal resistance
- Pb-free and RoHS compliant

RF Characteristics

Single-carrier WCDMA Specifications (tested in a WolfSpeed production test fixture)

$V_{DD} = 48\text{ V}$, $I_{DQ} = 87\text{ mA}$, $P_{OUT} = 5.5\text{ W}$ average, $f = 960\text{ MHz}$, 3GPP WCDMA signal, 3.84 MHz bandwidth, 10 dB PAR @ 0.01% CCDF

Characteristic	Symbol	Min.	Typ.	Max.	Unit
Linear Gain	G_{ps}	18.5	19.5	—	dB
Drain Efficiency	η_D	28	31.5	—	%
Adjacent Channel Power Ratio	ACPR	—	-33.5	-31	dBc

Note:

All published data at $T_{CASE} = 25^\circ\text{C}$ unless otherwise indicated

ESD: Electrostatic discharge sensitive device—observe handling precautions!





DC Characteristics (each side)

Characteristic	Symbol	Min.	Typ.	Max.	Unit	Conditions
Drain-Source Breakdown Voltage	$V_{BR(DSS)}$	105	—	—	V	$V_{GS} = 0\text{ V}, I_{DS} = 10\text{ mA}$
Drain Leakage Current	I_{DSS}	—	—	1	μA	$V_{DS} = 50\text{ V}, V_{GS} = 0\text{ V}$
		—	—	10		$V_{DS} = 105\text{ V}, V_{GS} = 0\text{ V}$
Gate Leakage Current	I_{GSS}	—	—	1		$V_{GS} = 10\text{ V}, V_{DS} = 0\text{ V}$
On-State Resistance	$R_{DS(on)}$	—	2.8	—	Ω	$V_{GS} = 10\text{ V}, V_{DS} = 0.1\text{ V}$
Operating Gate Voltage	V_{GS}	3	3.65	4	V	$V_{DS} = 48\text{ V}, I_{DQ} = 85\text{ mA}$

Maximum Ratings

Parameter	Symbol	Value	Unit
Drain-source Voltage	V_{DSS}	105	V
Gate-source Voltage	V_{GS}	-6 to +12	
Operating Voltage	V_{DD}	0 to +55	
Junction Temperature	T_J	225	$^{\circ}\text{C}$
Storage Temperature Range	T_{STG}	-65 to +150	

Thermal Characteristics

Parameter	Symbol	Value	Unit	Conditions
Thermal Resistance	$R_{\theta JC}$	2.6	$^{\circ}\text{C}/\text{W}$	$T_{CASE} = 70^{\circ}\text{C}, 25\text{ W CW}$

Ordering Information

Type and Version	Order Code	Package Description	Shipping
PTVA120252MT V1 R1K	PTVA120252MT-V1-R1K	PG-SON-16, plastic package	Tape & Reel, 1000 pcs

Typical RF Performance (data taken in production test fixture)

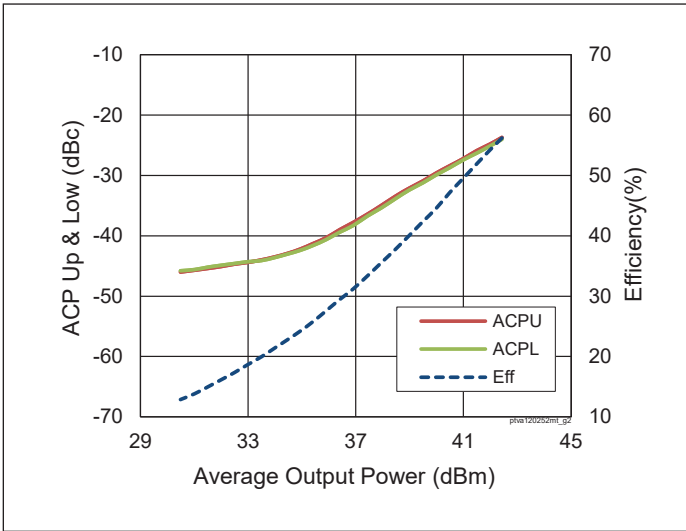

Figure 1. Single-carrier WCDMA Drive-up

$V_{DD} = 48\text{ V}$, $I_{DQ} = 95\text{ mA}$, $f = 960\text{ MHz}$,
3GPP WCDMA signal, PAR = 10 dB,
BW = 3.84 MHz

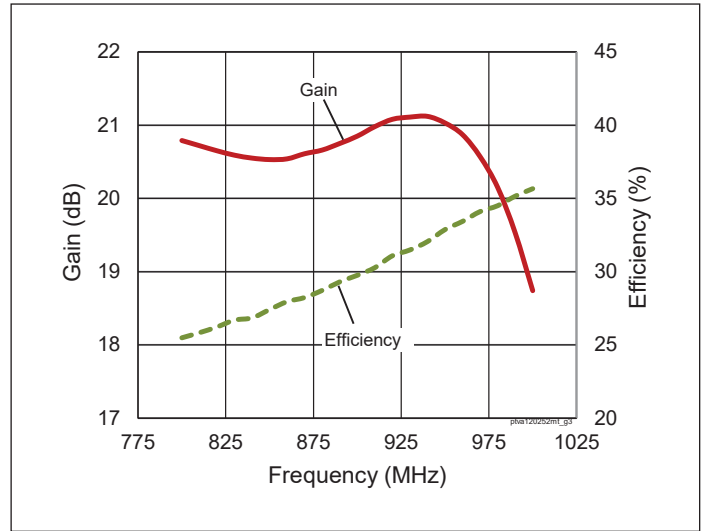

Figure 2. Single-carrier WCDMA Broadband Performance

$V_{DD} = 48\text{ V}$, $I_{DQ} = 95\text{ mA}$, $P_{OUT} = 37.4\text{ dBm}$,
3GPP WCDMA signal, PAR = 10 dB

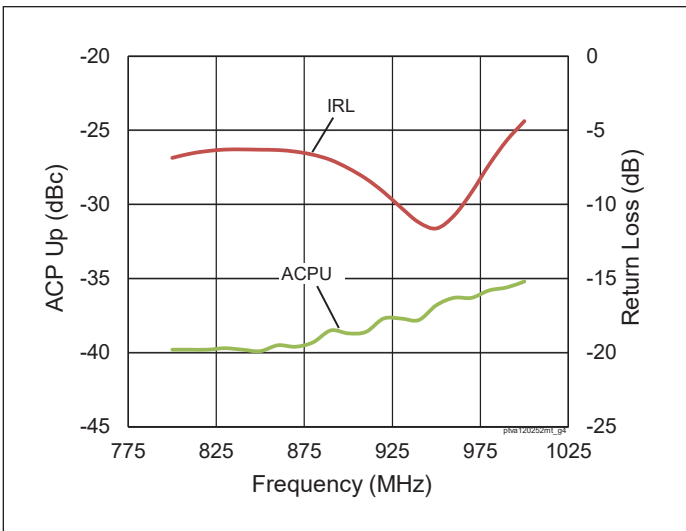

Figure 3. Single-carrier WCDMA Broadband Performance

$V_{DD} = 48\text{ V}$, $I_{DQ} = 95\text{ mA}$, $P_{OUT} = 37.4\text{ dBm}$,
3GPP WCDMA signal, PAR = 10 dB

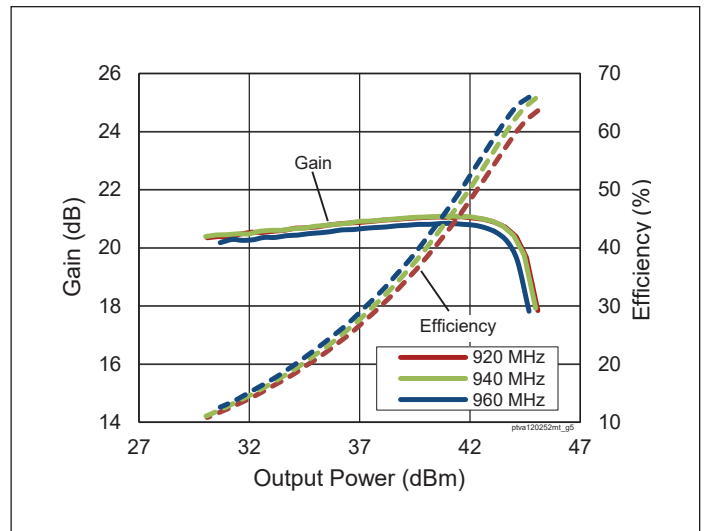

Figure 4. CW Performance

$V_{DD} = 48\text{ V}$, $I_{DQ} = 95\text{ mA}$



Typical Performance (cont.)

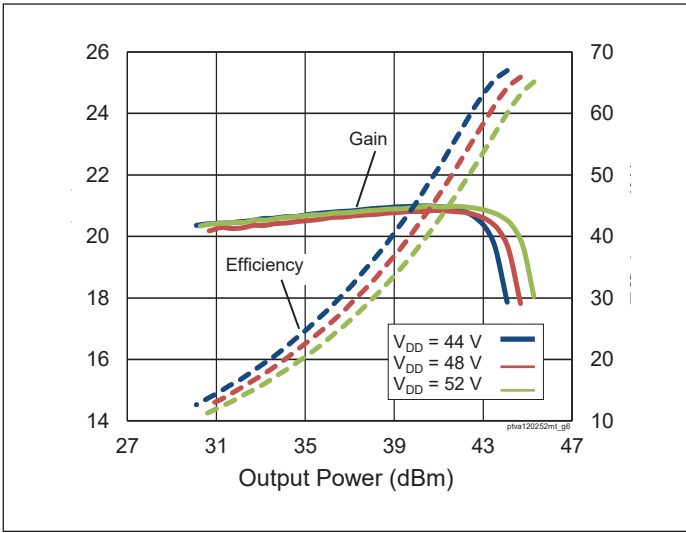

Figure 5. CW Performance at various V_{DD}
 $I_{DQ} = 95 \text{ mA}$, $f = 960 \text{ MHz}$

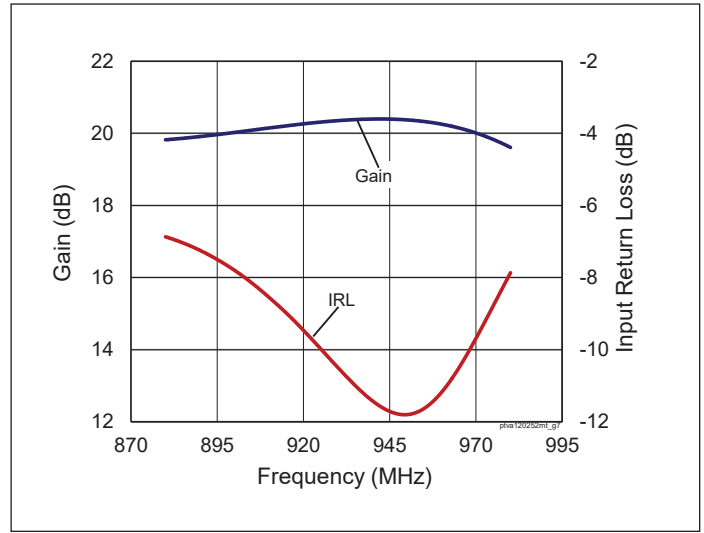

Figure 6. Small Signal CW Gain & Input Return Loss
 $V_{DD} = 48 \text{ V}$, $I_{DQ} = 95 \text{ mA}$

Load Pull Performance

Load Pull Performance – Pulsed CW signal: 10 μs , 10% duty cycle, 48 V, $I_{DQ} = 40 \text{ mA}$

Freq [MHz]	$Z_S [\Omega]$	P_{1dB}									
		Max Output Power					Max PAE				
		$Z_L [\Omega]$	Gain [dB]	$P_{OUT} [\text{dBm}]$	$P_{OUT} [\text{W}]$	PAE [%]	$Z_L [\Omega]$	Gain [dB]	$P_{OUT} [\text{dBm}]$	$P_{OUT} [\text{W}]$	PAE [%]
791	3.12+j7.44	18.94+j8.73	20.85	45.06	32.06	60.1	10.67+j26.27	23.27	41.79	15.10	70.8
821	3.2+j7	18.77+j9.38	20.54	45.03	31.84	59.7	10+j25.7	22.94	41.76	15.00	69.8
869	3.08+j6.56	20.14+j8.78	19.75	44.95	31.26	58.0	14.39+j21	21.46	43.59	22.86	68.0
894	3.02+j6.56	19.72+j9.41	19.41	44.79	30.13	57.5	9.22+j25.02	21.61	41.69	14.76	68.2
925	2.9+j6.12	20.67+j9.26	18.85	45.06	32.06	57.6	14.61+j21.69	20.44	43.55	22.65	66.0
960	2.86+j5.68	18.72+j9.45	18.2	44.80	30.20	55.6	9.75+j23.93	20.24	42.07	16.11	65.5



Evaluation Board, 925 – 960 MHz

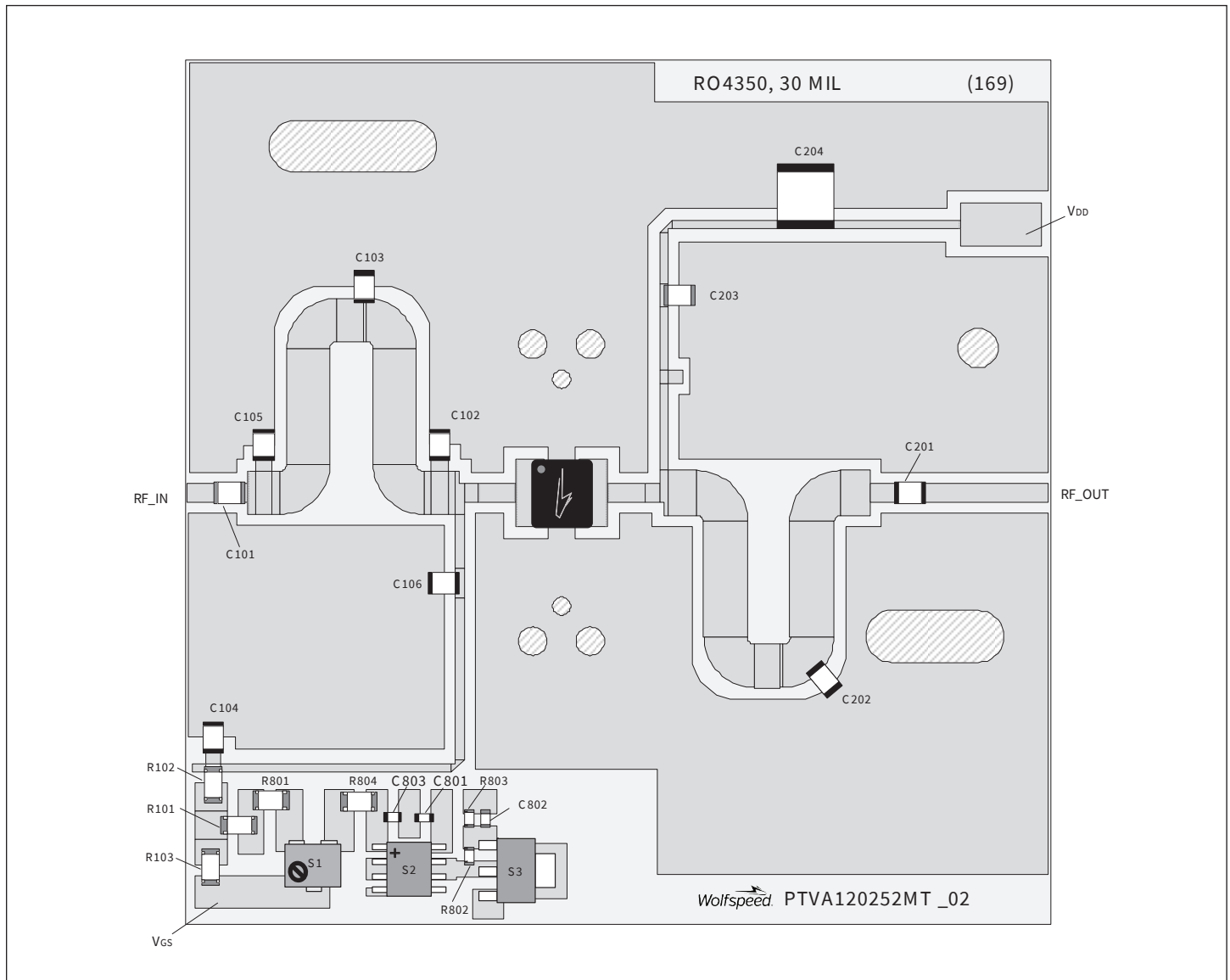

Reference circuit assembly diagram (not to scale)

Evaluation Board Part Number	LTN/PTVA120252MT-V1
PCB Information	Rogers 4350, 0.762 mm [0.030"] thick, 2 oz. copper, $\epsilon_r = 3.66$, $f = 925 - 960$ MHz

Find Gerber files for this test fixture on the Wolfspeed Web site at www.wolfspeed.com/RF



Components Information

Component	Description	Manufacturer	P/N
Input			
C101, C104, C106	Capacitor, 75 pF	ATC	ATC100B750JW500XB
C102	Capacitor, 14 pF	ATC	ATC100B140KW500XB
C103	Capacitor, 2.2 pF	ATC	ATC100B2R2DW500XB
C105	Capacitor, 2.5 pF	ATC	ATC100B2R5CW500XB
R101, R103	Resistor, 200 ohms	Panasonic Electronic Components	ERJ-8GEYJ201V
R102	Resistor, 10 ohms	Panasonic Electronic Components	ERJ-8GEYJ100V
Output			
C201, C203	Capacitor, 75 pF	ATC	ATC100B750JW500XB
C202	Capacitor, 2.0 pF	ATC	ATC100B2R0CW500XB
C204	Capacitor, 10 μ F	TDK Corporation	C5750X5R1H106K230KA
C801, C802, C803	Capacitor, 1000 pF	Panasonic Electronic Components	ECJ-1VB1H102K
R801	Resistor, 10 ohms	Panasonic Electronic Components	ERJ-8GEYJ100V
R802	Resistor, 1.2K ohms	Panasonic Electronic Components	ERJ-3GEYJ122V
R803	Resistor, 1.3K ohms	Panasonic Electronic Components	ERJ-3GEYJ132V
R804	Resistor, 100 ohms	Panasonic Electronic Components	ERJ-8GEYJ101V
S1	Potentiometer 2K ohms	Bourns Inc.	3224W-1-202E
S2	Voltage Regulator	Texas Instruments	LM78L05ACM
S3	Transistor	Infineon Technologies	BCP56



Pinout Diagram (top view)

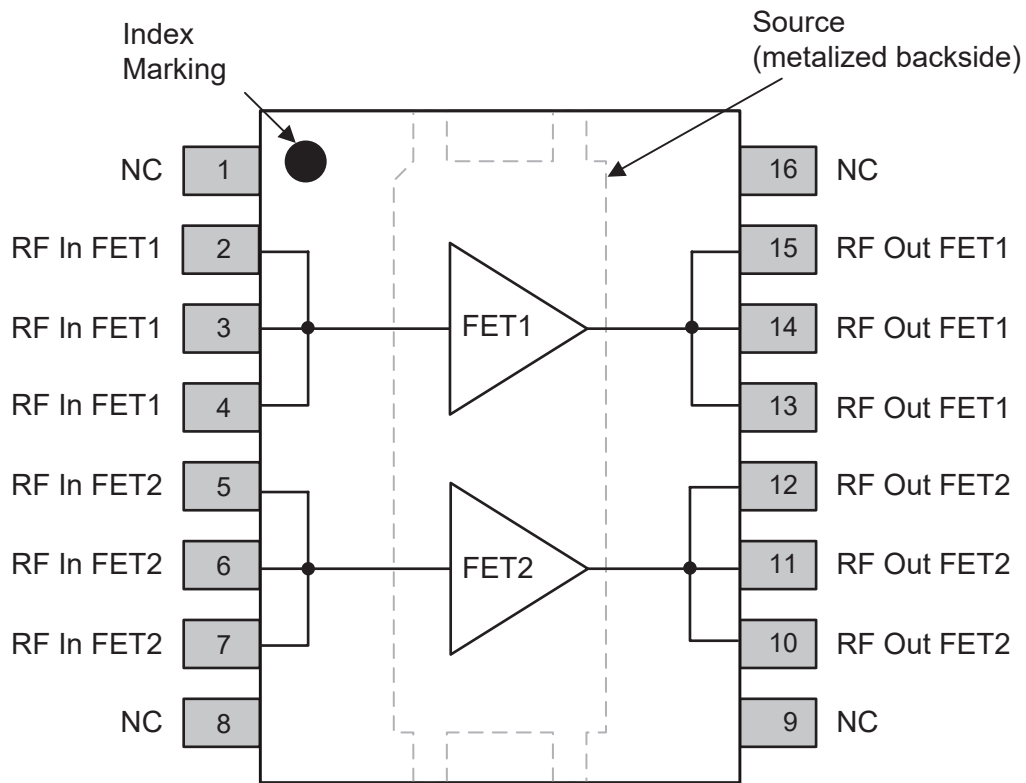

TOP VIEW

Description	Pin
Gate	2 - 7
Drain	10 - 15
Source	bottom metalization not connected 1, 8, 9, 16

Package Outline Specifications – Package PG-SON-16

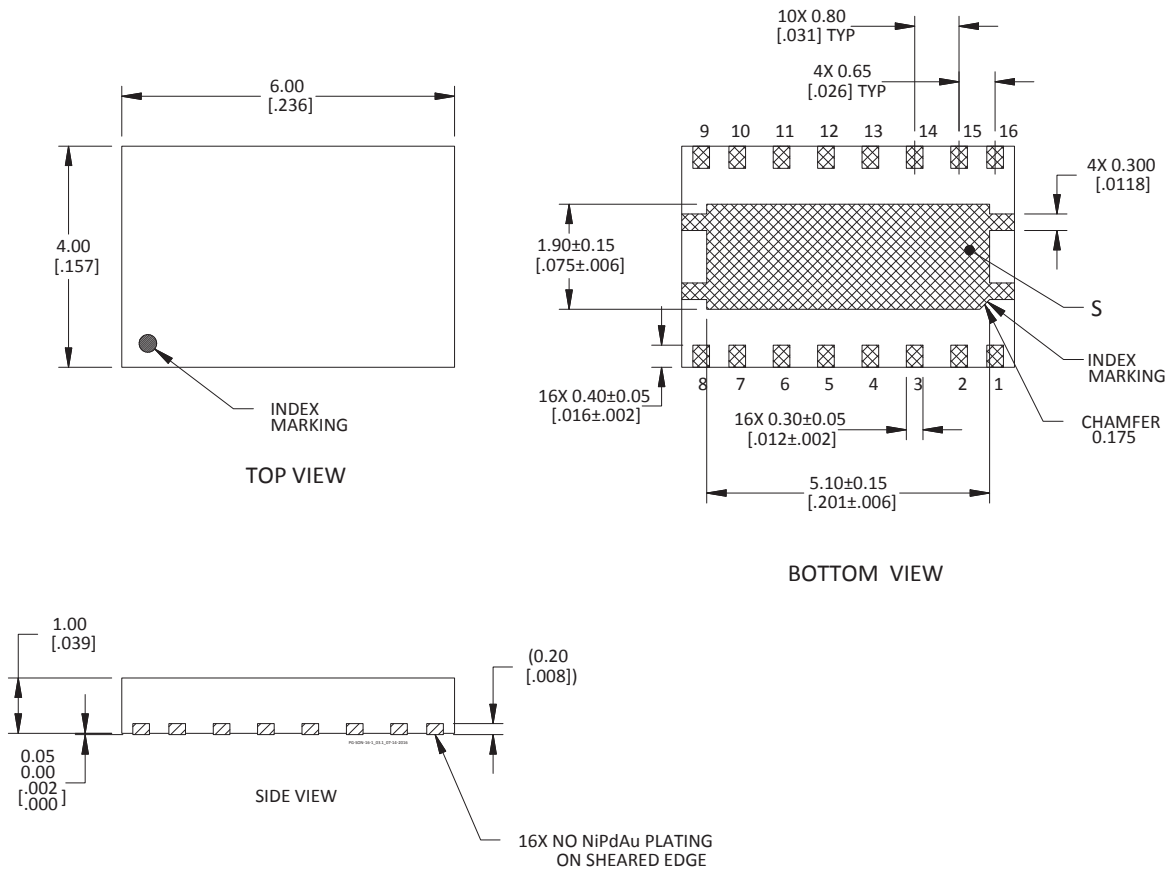

Diagram Notes—unless otherwise specified:

1. Interpret dimensions and tolerances per ASME Y14.5M-1994.
2. Primary dimensions are mm. Alternate dimensions are inches.
3. All tolerances ± 0.1 [.004].
4. Package dimensions 4.00 mm X 6.00 mm X 1.00 mm.
5. Pins: 2 – 7, gate; 10 – 15, drain; S, source (bottom metalization); 1, 8, 9, 16, not connected.
6. Gold plating thickness: 0.025 – 0.127 micron [1 – 5 microinch].

**For more information, please contact:**

4600 Silicon Drive
Durham, NC 27703 USA
Tel: +1.919.313.5300
www.wolfspeed.com/RF

Sales Contact
RFSales@wolfspeed.com

RF Product Marketing Contact
RFMarketing@wolfspeed.com

Notes & Disclaimer

Specifications are subject to change without notice. “Typical” parameters are the average values expected by Wolfspeed in large quantities and are provided for information purposes only. Wolfspeed products are not warranted or authorized for use as critical components in medical, life-saving, or life-sustaining applications, or other applications where a failure would reasonably be expected to cause severe personal injury or death. No responsibility is assumed by Wolfspeed for any infringement of patents or other rights of third parties which may result from use of the information contained herein. No license is granted by implication or otherwise under any patent or patent rights of Wolfspeed.

© 2022 Wolfspeed, Inc. All rights reserved. Wolfspeed® and the Wolfstreak logo are registered trademarks and the Wolfspeed logo is a trademark of Wolfspeed, Inc.
PATENT: <https://www.wolfspeed.com/legal/patents>

The information in this document is subject to change without notice.