

Wirewound, Surface Mount, Shielded Inductor

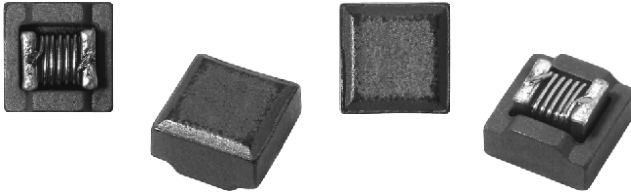

FEATURES

- Excellent solderability and resistance to soldering heat
- Suitable for reflow soldering
- High reliability and easy surface mount assembly
- Wide range of inductance values available
- Tape and reel packaging for automatic handling, 750/reel, EIA-481
- Compliant to RoHS directive 2002/95/EC



RoHS
COMPLIANT

STANDARD ELECTRICAL SPECIFICATIONS

IND. AT 100 kHz (μH)	TOL.	Q MIN. AT 1 MHz	SRF MIN. (MHz)	DCR MAX. (Ω)	RATED DC CURRENT (mA) ⁽¹⁾
1.0	± 20 %	35	344	0.05	1000
1.5	± 20 %	35	260	0.06	800
1.8	± 20 %	35	225	0.09	680
2.7	± 20 %	38	185	0.14	650
3.9	± 20 %	38	175	0.26	650
4.7	± 20 %	38	160	0.35	500
5.6	± 20 %	38	150	0.40	450
6.8	± 20 %	38	120	0.60	400
10	± 20 %	38	100	0.95	250
15	± 20 %	38	35	1.15	220
22	± 20 %	40	26	1.40	180
33	± 20 %	45	20	1.60	150
39	± 20 %	45	14	1.85	130
47	± 20 %	45	14	2.50	110
68	± 20 %	45	12	3.80	100
82	± 20 %	45	9.0	4.20	100
100	± 20 %	45	7.0	5.80	80
120	± 20 %	45	6.0	6.20	60
150	± 20 %	40	5.6	7.50	50
220	± 20 %	40	4.0	10.0	50
330	± 20 %	40	3.8	11.5	50
470	± 20 %	35	2.0	16.5	50
560	± 20 %	35	2.0	18.0	30
680	± 20 %	30	1.8	24.0	30
820	± 20 %	30	1.5	26.0	30
1000	± 20 %	30	1.3	30.0	30

Note
⁽¹⁾ For 15 °C rise

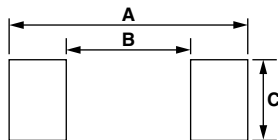
RECOMMENDED PATTERN



LENGTH (L)	WIDTH (W)	HEIGHT (H)	TERMINAL (S)
0.142 ± 0.008 [3.60 ± 0.2]	0.142 ± 0.008 [3.60 ± 0.2]	0.098 ± 0.008 [2.50 ± 0.2]	0.020 ± 0.004 [0.50 ± 0.1]

ELECTRICAL SPECIFICATIONS

Inductance Range: 1 μH to 1000 μH

Operating Temperature: - 40 °C to + 85 °C

Storage Temperature: - 40 °C to + 125 °C

Material: Ferrite with magnetic shield

TEST EQUIPMENT

- Inductance and Q is measured in HP-4286A RF LCR meter with HP-16193 fixture
- SRF is measured in HP-8753E RF network analyzer
- DCR is measured in HP-4338B milliohmeter

DIMENSIONS in inches [millimeters]

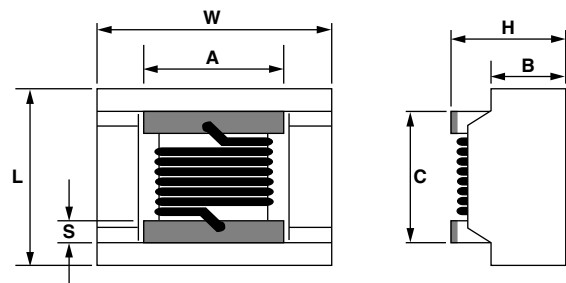

LENGTH (L)	WIDTH (W)	HEIGHT (H)	TERMINAL (S)
0.142 ± 0.008 [3.60 ± 0.2]	0.142 ± 0.008 [3.60 ± 0.2]	0.098 ± 0.008 [2.50 ± 0.2]	0.020 ± 0.004 [0.50 ± 0.1]
A		B	C
0.080 ± 0.004 [2.00 ± 0.1]		0.063 ± 0.008 [1.60 ± 0.2]	0.098 ± 0.004 [2.50 ± 0.1]

DESCRIPTION

ISC-1008	10 μH	± 20 %	ER	e3
MODEL	INDUCTANCE VALUE	INDUCTANCE TOLERANCE	PACKAGE CODE	JEDEC LEAD (Pb)-FREE STANDARD

GLOBAL PART NUMBER

I	S	C	1	0	0	8	E	R	1	0	0	M
PRODUCT FAMILY			SIZE				PACKAGE CODE		INDUCTANCE VALUE			TOL.

PERFORMANCE GRAPHS ISC-1008

Q vs. FREQUENCY

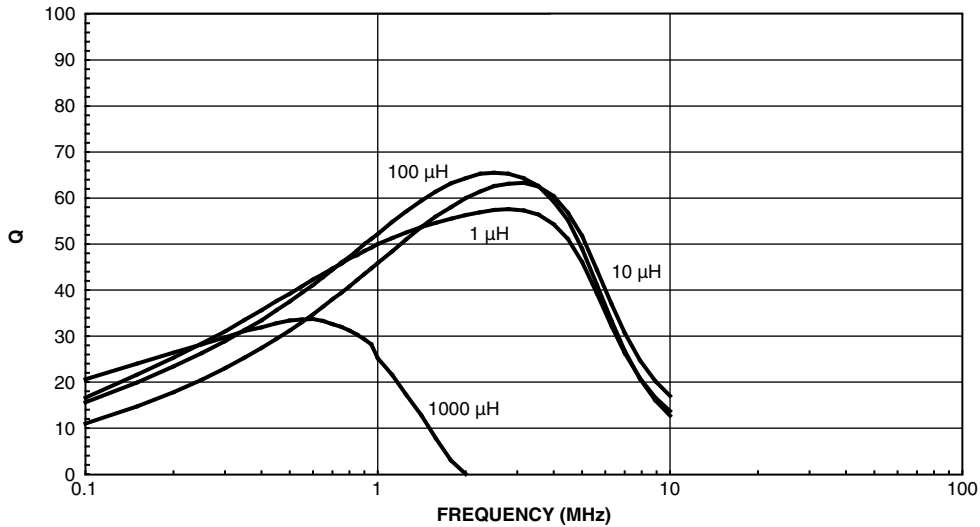

INDUCTANCE vs. FREQUENCY

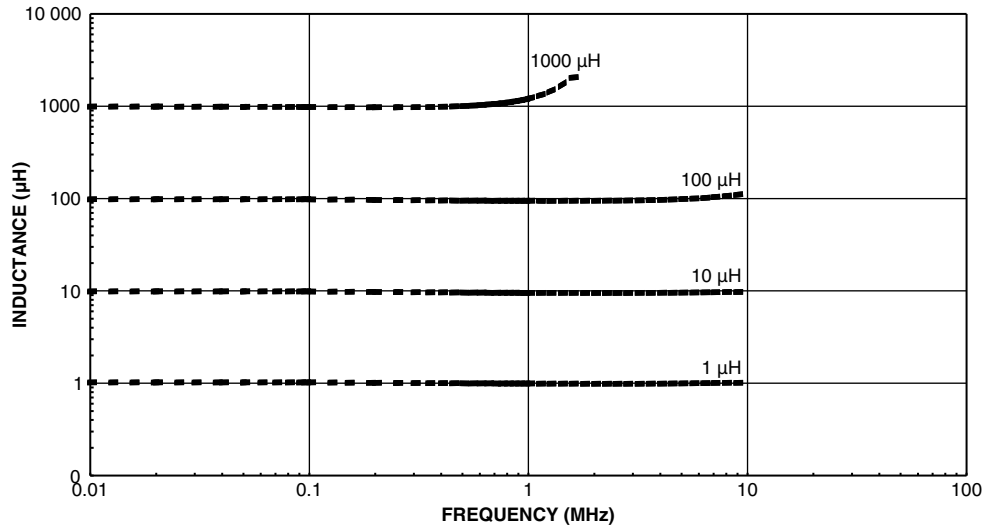

TAPE AND REEL SPECIFICATIONS in inches [millimeters]

REEL DIMENSIONS

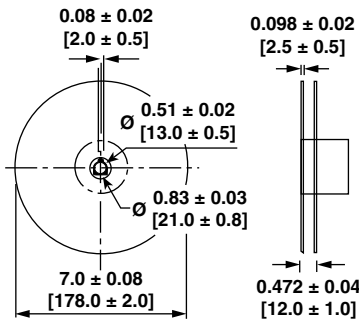

TAPE DIMENSIONS

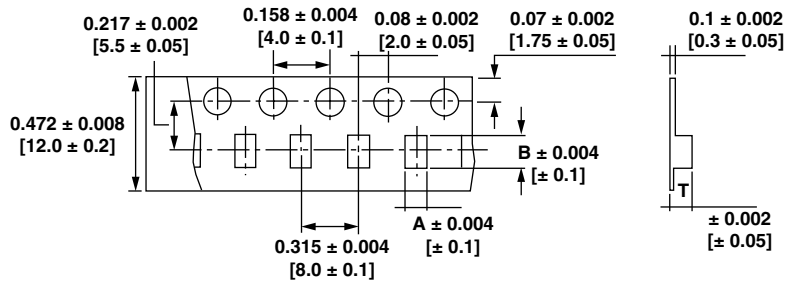

MODEL	UNITS PER REEL	MODEL	A	B	T
ISC-1008	750	ISC-1008	0.150 [3.8]	0.157 [4.0]	0.098 [2.5]



Disclaimer

ALL PRODUCT, PRODUCT SPECIFICATIONS AND DATA ARE SUBJECT TO CHANGE WITHOUT NOTICE TO IMPROVE RELIABILITY, FUNCTION OR DESIGN OR OTHERWISE.

Vishay Intertechnology, Inc., its affiliates, agents, and employees, and all persons acting on its or their behalf (collectively, "Vishay"), disclaim any and all liability for any errors, inaccuracies or incompleteness contained in any datasheet or in any other disclosure relating to any product.

Vishay makes no warranty, representation or guarantee regarding the suitability of the products for any particular purpose or the continuing production of any product. To the maximum extent permitted by applicable law, Vishay disclaims (i) any and all liability arising out of the application or use of any product, (ii) any and all liability, including without limitation special, consequential or incidental damages, and (iii) any and all implied warranties, including warranties of fitness for particular purpose, non-infringement and merchantability.

Statements regarding the suitability of products for certain types of applications are based on Vishay's knowledge of typical requirements that are often placed on Vishay products in generic applications. Such statements are not binding statements about the suitability of products for a particular application. It is the customer's responsibility to validate that a particular product with the properties described in the product specification is suitable for use in a particular application. Parameters provided in datasheets and / or specifications may vary in different applications and performance may vary over time. All operating parameters, including typical parameters, must be validated for each customer application by the customer's technical experts. Product specifications do not expand or otherwise modify Vishay's terms and conditions of purchase, including but not limited to the warranty expressed therein.

Hyperlinks included in this datasheet may direct users to third-party websites. These links are provided as a convenience and for informational purposes only. Inclusion of these hyperlinks does not constitute an endorsement or an approval by Vishay of any of the products, services or opinions of the corporation, organization or individual associated with the third-party website. Vishay disclaims any and all liability and bears no responsibility for the accuracy, legality or content of the third-party website or for that of subsequent links.

Except as expressly indicated in writing, Vishay products are not designed for use in medical, life-saving, or life-sustaining applications or for any other application in which the failure of the Vishay product could result in personal injury or death. Customers using or selling Vishay products not expressly indicated for use in such applications do so at their own risk. Please contact authorized Vishay personnel to obtain written terms and conditions regarding products designed for such applications.

No license, express or implied, by estoppel or otherwise, to any intellectual property rights is granted by this document or by any conduct of Vishay. Product names and markings noted herein may be trademarks of their respective owners.