

Data sheet | Item number: 2092-1112/000-5000

1-conductor female connector; push-button; Push-in CAGE CLAMP®; 2.5 mm²; Pin spacing 5 mm; 12-pole; Gripping plate; direct marking; 2,50 mm²; light gray

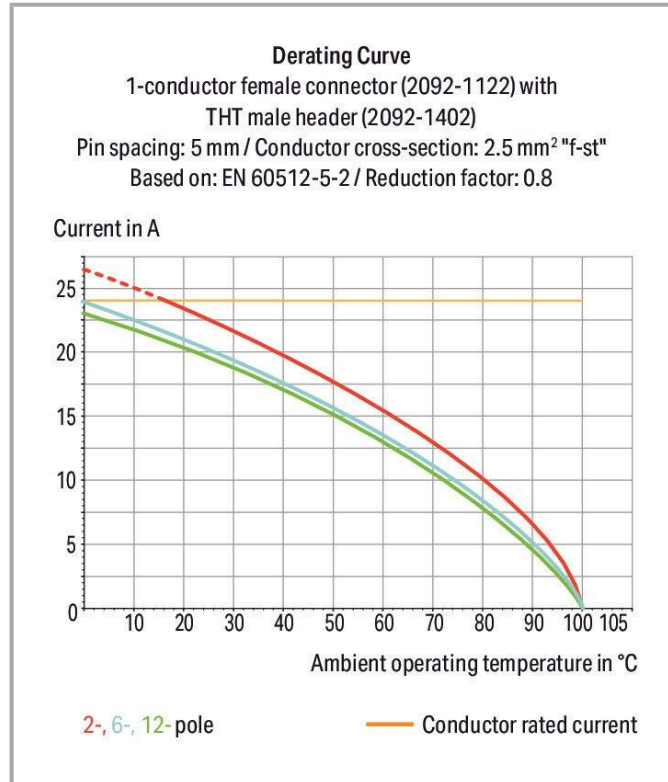

www.wago.com/2092-1112/000-5000

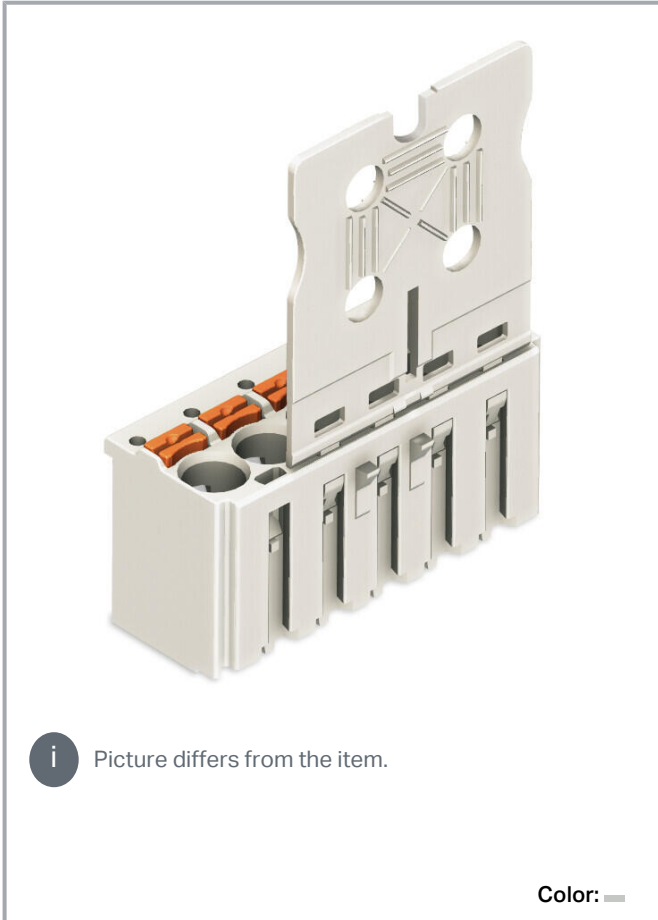

Subject to changes. Please also observe the further product documentation!

WAGO GmbH & Co. KG
Hansastr. 27
32423 Minden
Phone: +49571 887-0 | Fax: +49571 887-169
Email: info.de@wago.com | Web: www.wago.com

Do you have any questions about our products?
We are always happy to take your call at +49 (571) 887-44222.

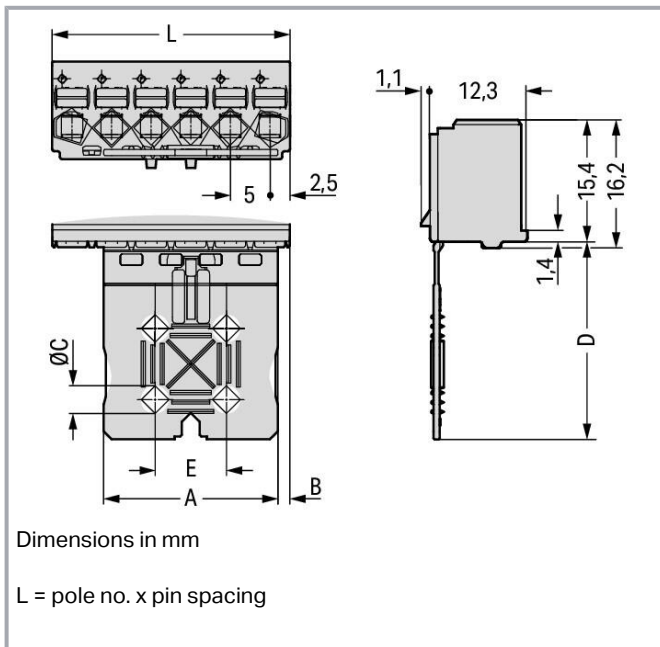

Item description

- Universal connection for all conductor types
- Simple, push-in termination of solid and ferruled conductors
- Easy-to-use design does not require specialty tools
- Ability to wire while mated or unmated
- Test port parallel to conductor entry – touch contact
- Integrated locking latches prevent accidental disconnection

Data

Notes

Safety information

The **picoMAX® Pluggable Connection System** includes connectors without breaking capacity in accordance with DIN EN 61984. When used as intended, these connectors must not be connected /disconnected when live or under load. The circuit design should ensure header pins, which can be touched, are not live when unmated.

Variants:

Direct marking

Other versions (or variants) can be requested from WAGO Sales or configured at <https://configurator.wago.com/>.

Electrical data

Subject to changes. Please also observe the further product documentation!

WAGO GmbH & Co. KG
Hansastr. 27
32423 Minden
Phone: +49571 887-0 | Fax: +49571 887-169
Email: info.de@wago.com | Web: www.wago.com

Do you have any questions about our products?
We are always happy to take your call at +49 (571) 887-44222.



Ratings per IEC/EN

Ratings per	IEC/EN 60664-1
Nominal voltage (III/3)	250 V
Rated impulse voltage (III/3)	4 kV
Rated voltage (III/2)	320 V
Rated impulse voltage (III/2)	4 kV
Nominal voltage (II/2)	630 V
Rated surge voltage (II/2)	4 kV
Rated current	16 A
Legend (ratings)	(III / 2) \triangleq Overvoltage category III / Pollution degree 2

Ratings per UL 1059

Approvals per	UL 1059
Rated voltage UL (Use Group B)	300 V
Rated current UL (Use Group B)	15 A
Rated voltage UL (Use Group D)	300 V
Rated current UL (Use Group D)	10 A

Connection data

Connection points	12
Total number of potentials	12
Number of connection types	1
Number of levels	1

Connection 1

Connection technology	Push-in CAGE CLAMP [®]
Actuation type	Push-button
Actuation direction 1	Operation parallel to conductor entry
Solid conductor	0.2 ... 2.5 mm ² / 24 ... 12 AWG
Fine-stranded conductor	0.2 ... 2.5 mm ² / 24 ... 12 AWG
Fine-stranded conductor; with insulated ferrule	0.25 ... 1.5 mm ²
Fine-stranded conductor; with uninsulated ferrule	0.25 ... 2.5 mm ²
Strip length	9 ... 10 mm / 0.35 ... 0.39 inches
Pole number	12

Subject to changes. Please also observe the further product documentation!



Physical data

Pin spacing	5 mm / 0.197 inches
Width	60 mm / 2.362 inches
Height	40.4 mm / 1.591 inches
Depth	13.4 mm / 0.528 inches

Mechanical Data

Variable coding	Yes
Design	with gripping plate
Anti-rotation protection	Yes

Plug-in connection

Contact type (pluggable connector)	Female connector/socket
Connector (connection type)	for conductor
Mismating protection	No
Plugging without loss of pin spacing	Yes
Locking of plug-in connection	none

Material Data

Note (material data)	Information on material specifications can be found here
Color	light gray
Material group	I
Insulation material	Polyphthalamide (PPA GF)
Flammability class per UL94	V0
Clamping spring material	Chrome-nickel spring steel (CrNi)
Contact material	Electrolytic copper (E_{Cu})
Contact plating	Tin
Fire load	0.07 MJ
Weight	12.6 g

Environmental requirements

Limit temperature range	-60 ... +100 °C
Processing temperature	-35 ... +60 °C

Subject to changes. Please also observe the further product documentation!

Commercial data





eCl@ss 10.0	27-14-11-06
eCl@ss 9.0	27-14-11-06
ETIM 8.0	EC001284
ETIM 7.0	EC001284
PU (SPU)	50 pcs
Packaging type	Box
Country of origin	DE
GTIN	4050821353867
Customs tariff number	85366990990

Environmental Product Compliance

RoHS Compliance Status	Compliant, No Exemption
------------------------	-------------------------

Approvals / Certificates

General approvals

Logo	Approval	Additional Approval Text	Certificate name
	CB DEKRA Certification B.V.	IEC 61984	NL-49737 /A1
	CSA DEKRA Certification B.V.	C22.2	2362521
	cURus Underwriters Laboratories Inc.	UL 1059	E45172
	KEMA/KEUR DEKRA Certification B.V.	EN 61984	71- 102261 REV.2
	UL Underwriters Laboratories Inc.	UL 1977	E45171

Subject to changes. Please also observe the further product documentation!

Counterpart



Item no.2092-1432

THT male header; 1.4 mm Ø solder pin; angled; Pin spacing 5 mm; 12-pole; light gray

www.wago.com/2092-1432



Item no.2092-1412

THT male header; 1.4 mm Ø solder pin; straight; Pin spacing 5 mm; 12-pole; light gray

www.wago.com/2092-1412

Optional accessories

Testing and measuring

Testing accessories



Item no.: 735-500

WAGO Test pin; 1 mm Ø; 30 V AC / 60 V DC; CAT0; 1 A; 6 mm uninsulated; Test lead for soldering up to 0,5mm²

www.wago.com/735-500

Tool

Operating tool



Item no.: 210-719

Operating tool; Blade: 2.5 x 0.4 mm; with a partially insulated shaft

www.wago.com/210-719

Downloads

Documentation

Additional Information

Technical Section	2019 Apr 3	pdf	Download
Technical explanations		2.0 MB	

Environmental Product Compliance

Compliance Search

Environmental Product Compliance 2092-1112/000-5000	URL	Download
1-conductor female connector; push-button; Push-in CAGE CLAMP®; 2.5 mm ² ; Pin spacing 5 mm; 12-pole; Gripping plate; direct marking; 2,50 mm ² ; light gray		

Installation Notes

Subject to changes. Please also observe the further product documentation!

WAGO GmbH & Co. KG
 Hansastr. 27
 32423 Minden
 Phone: +49571 887-0 | Fax: +49571 887-169
 Email: info.de@wago.com | Web: www.wago.com

Do you have any questions about our products?
 We are always happy to take your call at +49 (571) 887-44222.

Locking system

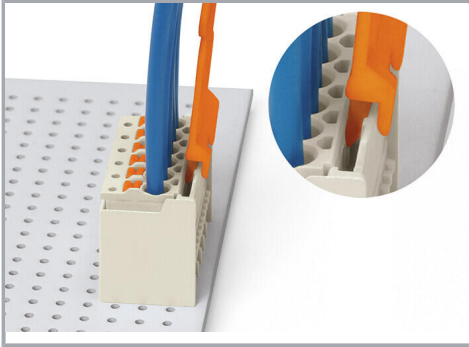

Disconnecting a female connector via unlocking tool. Plug unlocking tool into the male header's locking latch.

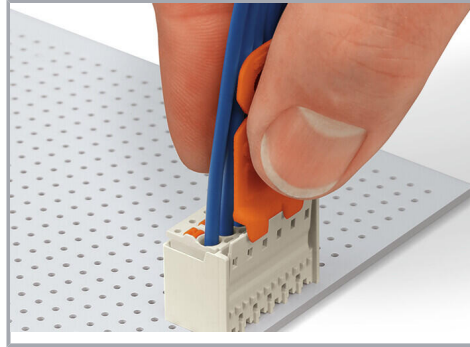

Insert unlocking tool until it hits the backstop. Wedge opens locking latches.

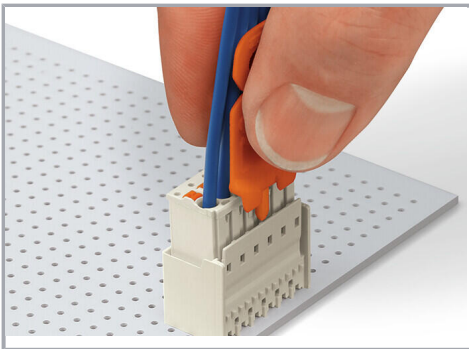

Pull on both unlocking tool and conductors to remove female connector from male header.

Conductor termination

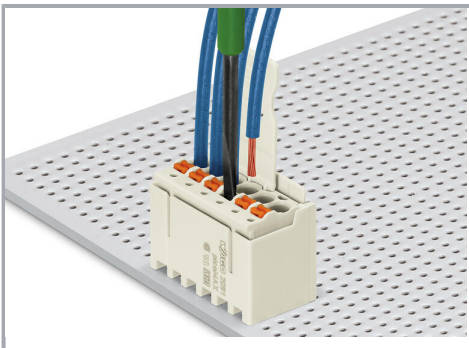

Inserting fine-stranded conductor into mated female connector via push-button.

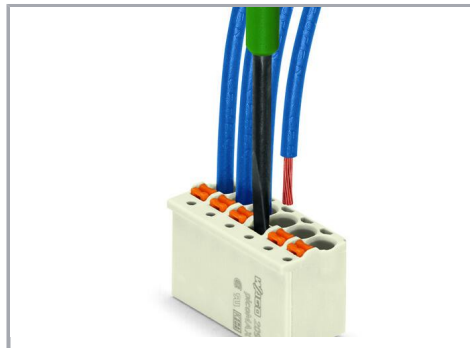

Inserting a fine-stranded conductor into an unmated female connector via push-button.

Subject to changes. Please also observe the further product documentation!

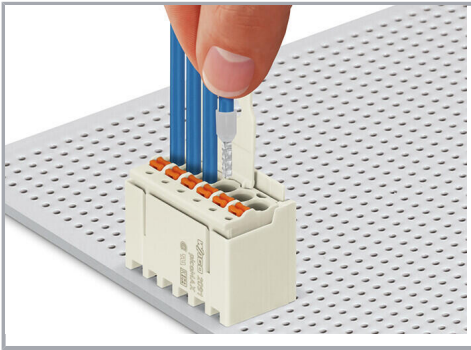

Inserting solid and ferruled conductors via push-in termination.

Marking



Pole marking via factory direct marking.

Coding

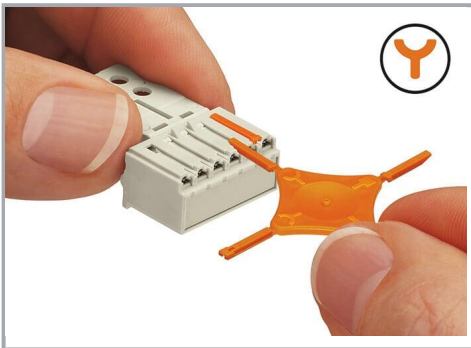

Coding a female connector (via coding key carrier and two keys for female connector, see symbol).

Testing

Subject to changes. Please also observe the further product documentation!

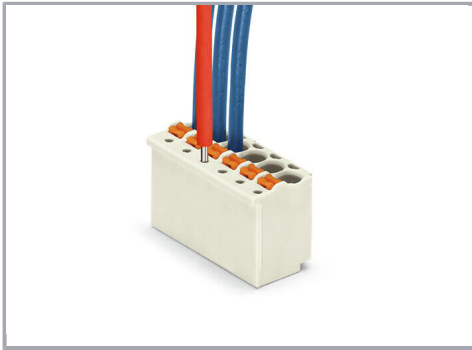

Testing via 1 mm Ø test pin – touch contact.

Subject to changes. Please also observe the further product documentation!