

Data sheet | Item number: 880-832

4-conductor through terminal block; 4 mm²; with test port; without shield contact; center marking; for DIN-rail 35 x 15 and 35 x 7.5; CAGE CLAMP®; 4,00 mm²; orange

www.wago.com/880-832

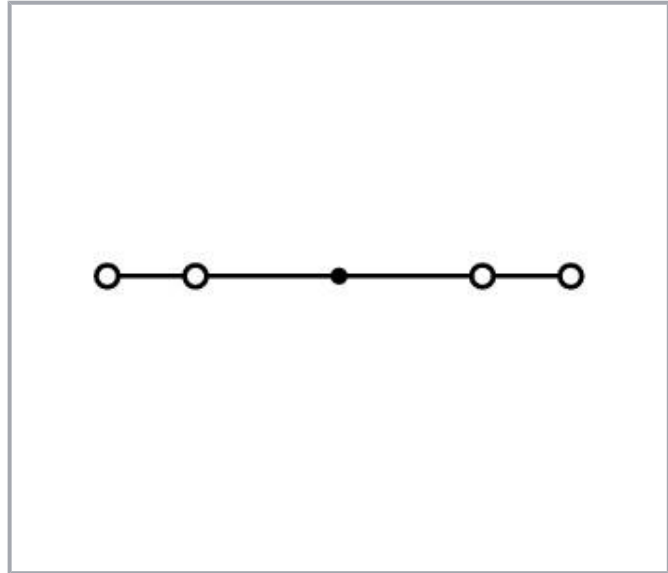
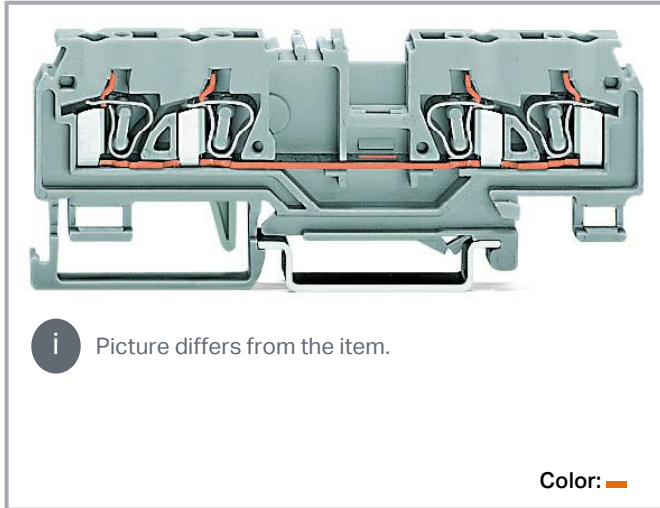

Data

Electrical data

Ratings per IEC/EN

| Ratings per | IEC/EN 60947-7-1 |
|-------------------------------|---|
| Nominal voltage (III/3) | 800 V |
| Rated impulse voltage (III/3) | 8 kV |
| Rated current | 20 A |
| Legend (ratings) | (III / 3) ≙ Overvoltage category III / Pollution degree 3 |

Power loss

| | |
|--|---------|
| Power loss, per pole (potential) | 0.4 W |
| Rated current I_N for specified power loss | 20 A |
| Resistance value for specified, current-dependent power loss | 0.001 Ω |

Connection data

| | |
|-------------------|---|
| Connection points | 4 |
|-------------------|---|

Subject to changes. Please also observe the further product documentation!

WAGO GmbH & Co. KG
Hansastr. 27
32423 Minden
Phone: +49571 887-0 | Fax: +49571 887-169
Email: info.de@wago.com | Web: www.wago.com

Do you have any questions about our products?
We are always happy to take your call at +49 (571) 887-44222.



| | |
|----------------------------|---|
| Total number of potentials | 1 |
| Number of levels | 1 |

Connection 1

| | |
|---------------------------------|--|
| Connection technology | CAGE CLAMP® |
| Actuation type | Operating tool |
| Connectable conductor materials | Copper |
| Solid conductor | 0.08 ... 4 mm ² / 28 ... 12 AWG |
| Fine-stranded conductor | 0.08 ... 4 mm ² / 28 ... 12 AWG |
| Strip length | 8 ... 9 mm / 0.31 ... 0.35 inches |
| Wiring direction | Front-entry wiring |

Physical data

| | |
|-----------------------------------|----------------------|
| Width | 5 mm / 0.197 inches |
| Height | 87 mm / 3.425 inches |
| Depth from upper-edge of DIN-rail | 29 mm / 1.142 inches |

Mechanical Data

| | |
|---------------|----------------|
| Mounting type | DIN-35 rail |
| Marking level | Center marking |

Material Data

| | |
|-----------------------------|--|
| Note (material data) | Information on material specifications can be found here |
| Color | orange |
| Material group | I |
| Insulation material | Polyamide (PA66) |
| Flammability class per UL94 | V0 |
| Fire load | 0.176 MJ |
| Weight | 10.8 g |

Environmental requirements

| | |
|----------------------------------|-----------------|
| Processing temperature | -35 ... +85 °C |
| Continuous operating temperature | -60 ... +105 °C |

Subject to changes. Please also observe the further product documentation!

WAGO GmbH & Co. KG
 Hansastr. 27
 32423 Minden
 Phone: +49571 887-0 | Fax: +49571 887-169
 Email: info.de@wago.com | Web: www.wago.com

Do you have any questions about our products?
 We are always happy to take your call at +49 (571) 887-44222.

Commercial data



| | |
|-----------------------|----------------------------------|
| Product Group | 1 (Rail Mounted Terminal Blocks) |
| eCl@ss 10.0 | 27-14-11-20 |
| eCl@ss 9.0 | 27-14-11-20 |
| ETIM 8.0 | EC000897 |
| ETIM 7.0 | EC000897 |
| PU (SPU) | 50 pcs |
| Packaging type | box |
| Country of origin | PL |
| GTIN | 4044918560788 |
| Customs tariff number | 85369010000 |

Environmental Product Compliance

| | |
|------------------------|-------------------------|
| RoHS Compliance Status | Compliant, No Exemption |
|------------------------|-------------------------|

Approvals / Certificates

General approvals

| Logo | Approval | Additional Approval Text | Certificate name |
|--|--------------------------------------|--------------------------|------------------|
|  | CCA DEKRA Certification B.V. | EN 60947 | NTR-NL 7339 |
|  | CCA DEKRA Certification B.V. | EN 60947 | 2174152.01 |
|  | UL Underwriters Laboratories Inc. | UL 1059 | E45172 |

Declarations of conformity and manufacturer's declarations

| Logo | Approval | Additional Approval Text | Certificate name |
|--|--|--------------------------|------------------|
|  | EU-Declaration of Conformity WAGO GmbH & Co. KG | - | - |
| | UK-Declaration of Conformity | - | - |

Subject to changes. Please also observe the further product documentation!



WAGO GmbH & Co. KG
 Hansastr. 27
 32423 Minden
 Phone: +49571 887-0 | Fax: +49571 887-169
 Email: info.de@wago.com | Web: www.wago.com

Do you have any questions about our products?
 We are always happy to take your call at +49 (571) 887-44222.





WAGO GmbH & Co. KG

Approvals for marine applications

| Logo | Approval | Additional Approval Text | Certificate name |
|--|---|--------------------------|--------------------------|
|  | ABS American Bureau of Shipping | EN 60947 | 20- HG1941090- PDA |
|  | DNV GL Det Norske Veritas, Germanischer Lloyd | - | TAE00001V2 |



Required accessories

End plate

| End plate | | |
|--|--|--|
|  | Item no.: 880-344 End and intermediate plate; 2.5 mm thick; gray | www.wago.com/880-344 |
|  | Item no.: 880-346 End and intermediate plate; 2.5 mm thick; orange | www.wago.com/880-346 |

Optional accessories



















Insulation stop

| Insulation stop | | |
|--|--|--|
|  | Item no.: 280-472 Insulation stop; 0.75 - 1 mm ² ; 5 pieces/strip; black | www.wago.com/280-472 |
|  | Item no.: 280-470 Insulation stop; 0.08 - 0.2 mm ² "s" (0.14 mm ² "f-st"); 5 pieces/strip; white | www.wago.com/280-470 |
|  | Item no.: 280-471 Insulation stop; 0.25 - 0.5 mm ² ; 5 pieces/strip; light gray | www.wago.com/280-471 |

Ferrule

| Ferrule | | |
|---|---|--|
|  | Item no.: 216-106 Ferrule; Sleeve for 2.5 mm ² / AWG 14; uninsulated; electro-tin plated; silver-colored | www.wago.com/216-106 |













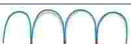

Subject to changes. Please also observe the further product documentation!

| | | |
|---|---|--|
|  | Item no.: 216-107 Ferrule; Sleeve for 4 mm ² / AWG 12; uninsulated; electro-tin plated | www.wago.com/216-107 |
|  | Item no.: 216-108 Ferrule; Sleeve for 6 mm ² / AWG 10; uninsulated; electro-tin plated; silver-colored | www.wago.com/216-108 |
|  | Item no.: 216-109 Ferrule; Sleeve for 10 mm ² / AWG 8; uninsulated; electro-tin plated | www.wago.com/216-109 |
|  | Item no.: 216-110 Ferrule; Sleeve for 16 mm ² / AWG 6; uninsulated; electro-tin plated; brown metallic | www.wago.com/216-110 |
|  | Item no.: 216-123 Ferrule; Sleeve for 1 mm ² / AWG 18; uninsulated; electro-tin plated; silver-colored | www.wago.com/216-123 |
|  | Item no.: 216-122 Ferrule; Sleeve for 0.75 mm ² / AWG 20; uninsulated; electro-tin plated; silver-colored | www.wago.com/216-122 |
|  | Item no.: 216-124 Ferrule; Sleeve for 1.5 mm ² / AWG 16; uninsulated; electro-tin plated | www.wago.com/216-124 |
|  | Item no.: 216-142 Ferrule; Sleeve for 0.75 mm ² / 18 AWG; uninsulated; electro-tin plated; electrolytic copper; gastight crimped; acc. to DIN 46228, Part 1/08.92 | www.wago.com/216-142 |
|  | Item no.: 216-132 Ferrule; Sleeve for 0.34 mm ² / AWG 24; uninsulated; electro-tin plated | www.wago.com/216-132 |
|  | Item no.: 216-121 Ferrule; Sleeve for 0.5 mm ² / AWG 22; uninsulated; electro-tin plated; silver-colored | www.wago.com/216-121 |
|  | Item no.: 216-143 Ferrule; Sleeve for 1 mm ² / AWG 18; uninsulated; electro-tin plated; electrolytic copper; gastight crimped; acc. to DIN 46228, Part 1/08.92 | www.wago.com/216-143 |
|  | Item no.: 216-131 Ferrule; Sleeve for 0.25 mm ² / AWG 24; uninsulated; electro-tin plated; silver-colored | www.wago.com/216-131 |
|  | Item no.: 216-141 Ferrule; Sleeve for 0.5 mm ² / 20 AWG; uninsulated; electro-tin plated; electrolytic copper; gastight crimped; acc. to DIN 46228, Part 1/08.92 | www.wago.com/216-141 |
|  | Item no.: 216-152 Ferrule; Sleeve for 0.34 mm ² / AWG 24; uninsulated; electro-tin plated | www.wago.com/216-152 |
|  | Item no.: 216-207 Ferrule; Sleeve for 4 mm ² / AWG 12; insulated; electro-tin plated; gray | www.wago.com/216-207 |
|  | Item no.: 216-151 Ferrule; Sleeve for 0.25 mm ² / AWG 24; uninsulated; electro-tin plated | www.wago.com/216-151 |
|  | Item no.: 216-209 Ferrule; Sleeve for 10 mm ² / AWG 8; insulated; electro-tin plated; red | www.wago.com/216-209 |
|  | Item no.: 216-144 Ferrule; Sleeve for 1.5 mm ² / AWG 16; uninsulated; electro-tin plated; electrolytic copper; gastight crimped; acc. to DIN 46228, Part 1/08.92; silver-colored | www.wago.com/216-144 |







Subject to changes. Please also observe the further product documentation!

| | | |
|---|--|--|
|  | Item no.: 216-208 Ferrule; Sleeve for 6 mm ² / AWG 10; insulated; electro-tin plated; electrolytic copper; gastight crimped; acc. to DIN 46228, Part 4/09.90; yellow | www.wago.com/216-208 |
|  | Item no.: 216-223 Ferrule; Sleeve for 1 mm ² / AWG 18; insulated; electro-tin plated; red | www.wago.com/216-223 |
|  | Item no.: 216-210 Ferrule; Sleeve for 16 mm ² / AWG 6; insulated; electro-tin plated; electrolytic copper; gastight crimped; acc. to DIN 46228, Part 4/09.90; blue | www.wago.com/216-210 |
|  | Item no.: 216-241 Ferrule; Sleeve for 0.5 mm ² / 20 AWG; insulated; electro-tin plated; electrolytic copper; gastight crimped; acc. to DIN 46228, Part 4/09.90; white | www.wago.com/216-241 |
|  | Item no.: 216-242 Ferrule; Sleeve for 0.75 mm ² / 18 AWG; insulated; electro-tin plated; electrolytic copper; gastight crimped; acc. to DIN 46228, Part 4/09.90; gray | www.wago.com/216-242 |
|  | Item no.: 216-222 Ferrule; Sleeve for 0.75 mm ² / 18 AWG; insulated; electro-tin plated; gray | www.wago.com/216-222 |
|  | Item no.: 216-221 Ferrule; Sleeve for 0.5 mm ² / 20 AWG; insulated; electro-tin plated; white | www.wago.com/216-221 |
|  | Item no.: 216-224 Ferrule; Sleeve for 1.5 mm ² / AWG 16; insulated; electro-tin plated; black | www.wago.com/216-224 |
|  | Item no.: 216-243 Ferrule; Sleeve for 1 mm ² / AWG 18; insulated; electro-tin plated; electrolytic copper; gastight crimped; acc. to DIN 46228, Part 4/09.90; red | www.wago.com/216-243 |
|  | Item no.: 216-244 Ferrule; Sleeve for 1.5 mm ² / AWG 16; insulated; electro-tin plated; electrolytic copper; gastight crimped; acc. to DIN 46228, Part 4/09.90; black | www.wago.com/216-244 |
|  | Item no.: 216-263 Ferrule; Sleeve for 1 mm ² / AWG 18; insulated; electro-tin plated; electrolytic copper; gastight crimped; acc. to DIN 46228, Part 4/09.90; red | www.wago.com/216-263 |
|  | Item no.: 216-246 Ferrule; Sleeve for 2.5 mm ² / AWG 14; insulated; electro-tin plated; electrolytic copper; gastight crimped; acc. to DIN 46228, Part 4/09.90; blue | www.wago.com/216-246 |
|  | Item no.: 216-266 Ferrule; Sleeve for 2.5 mm ² / AWG 14; insulated; electro-tin plated; electrolytic copper; gastight crimped; acc. to DIN 46228, Part 4/09.90; blue | www.wago.com/216-266 |
|  | Item no.: 216-264 Ferrule; Sleeve for 1.5 mm ² / AWG 16; insulated; electro-tin plated; electrolytic copper; gastight crimped; acc. to DIN 46228, Part 4/09.90; black | www.wago.com/216-264 |
|  | Item no.: 216-284 Ferrule; Sleeve for 1.5 mm ² / AWG 16; insulated; electro-tin plated; electrolytic copper; gastight crimped; acc. to DIN 46228, Part 4/09.90; black | www.wago.com/216-284 |
|  | Item no.: 216-286 Ferrule; Sleeve for 2.5 mm ² / AWG 14; insulated; electro-tin plated; electrolytic copper; gastight crimped; acc. to DIN 46228, Part 4/09.90; blue | www.wago.com/216-286 |
| | Item no.: 216-287 | |









Subject to changes. Please also observe the further product documentation!

| | | |
|--|--|--|
|  | Ferrule; Sleeve for 4 mm ² / AWG 12; insulated; electro-tin plated; electrolytic copper; gastight crimped; acc. to DIN 46228, Part 4/09.90; gray | www.wago.com/216-287 |
|  | Item no.: 216-262 Ferrule; Sleeve for 0.75 mm ² / 18 AWG; insulated; electro-tin plated; electrolytic copper; gastight crimped; acc. to DIN 46228, Part 4/09.90; gray | www.wago.com/216-262 |
|  | Item no.: 216-288 Ferrule; Sleeve for 6 mm ² / AWG 10; insulated; electro-tin plated; electrolytic copper; gastight crimped; acc. to DIN 46228, Part 4/09.90; yellow | www.wago.com/216-288 |
|  | Item no.: 216-289 Ferrule; Sleeve for 10 mm ² / AWG 8; insulated; electro-tin plated; electrolytic copper; gastight crimped; acc. to DIN 46228, Part 4/09.90; red | www.wago.com/216-289 |
|  | Item no.: 216-321 Ferrule; Sleeve for 0.25 mm ² / AWG 24; insulated; electro-tin plated; yellow | www.wago.com/216-321 |
|  | Item no.: 216-322 Ferrule; Sleeve for 0.34 mm ² / 22 AWG; insulated; electro-tin plated; light turquoise | www.wago.com/216-322 |
|  | Item no.: 216-267 Ferrule; Sleeve for 4 mm ² / AWG 12; insulated; electro-tin plated; electrolytic copper; gastight crimped; acc. to DIN 46228, Part 4/09.90; gray | www.wago.com/216-267 |
| Jumpers | | |
| Jumper | | |
|  | Item no.: 210-123 Wire commoning chain; insulated; blue | www.wago.com/210-123 |
|  | Item no.: 280-402 Jumper; insulated; gray | www.wago.com/280-402 |
|  | Item no.: 210-103 Wire commoning chain; insulated; black | www.wago.com/210-103 |
|  | Item no.: 280-409 Jumper; insulated; gray | www.wago.com/280-409 |
|  | Item no.: 280-422 Jumper; insulated; yellow-green | www.wago.com/280-422 |
|  | Item no.: 709-110 Wire commoning chain; 2.5 mm ² ; insulated; black | www.wago.com/709-110 |
|  | Item no.: 709-112 Wire commoning chain; 2.5 mm ² ; insulated; black | www.wago.com/709-112 |
|  | Item no.: 709-111 Wire commoning chain; 2.5 mm ² ; insulated; black | www.wago.com/709-111 |
|  | Item no.: 780-454 Staggered jumper; from 1 to 4; insulated; gray | www.wago.com/780-454 |







Subject to changes. Please also observe the further product documentation!

| | | |
|--|--|--|
|  | Item no.: 780-452 Staggered jumper; from 1 to 2; insulated; gray | www.wago.com/780-452 |
|  | Item no.: 780-453 Staggered jumper; from 1 to 3; insulated; gray | www.wago.com/780-453 |
|  | Item no.: 780-457 Staggered jumper; from 1 to 7; insulated; gray | www.wago.com/780-457 |
|  | Item no.: 780-456 Staggered jumper; from 1 to 6; insulated; gray | www.wago.com/780-456 |
|  | Item no.: 780-455 Staggered jumper; from 1 to 5; insulated; gray | www.wago.com/780-455 |
|  | Item no.: 780-458 Staggered jumper; from 1 to 8; insulated; gray | www.wago.com/780-458 |

Marking accessories

| Marker | | |
|--|---|--|
|  | Item no.: 2009-115/000-002 WMB-Inline; for Smart Printer; 1500 pieces on roll; stretchable 5 - 5.2 mm; plain; snap-on type; yellow | www.wago.com/2009-115/000-002 |
|  | Item no.: 2009-115/000-007 WMB-Inline; for Smart Printer; 1500 pieces on roll; stretchable 5 - 5.2 mm; plain; snap-on type; gray | www.wago.com/2009-115/000-007 |
|  | Item no.: 2009-115/000-017 WMB-Inline; for Smart Printer; 1500 pieces on roll; stretchable 5 - 5.2 mm; plain; snap-on type; light green | www.wago.com/2009-115/000-017 |
|  | Item no.: 2009-115/000-023 WMB-Inline; for Smart Printer; 1500 pieces on roll; stretchable 5 - 5.2 mm; plain; snap-on type; green | www.wago.com/2009-115/000-023 |
|  | Item no.: 2009-115/000-024 WMB-Inline; for Smart Printer; 1500 pieces on roll; stretchable 5 - 5.2 mm; plain; snap-on type; violet | www.wago.com/2009-115/000-024 |
|  | Item no.: 2009-145/000-006 Mini-WSB Inline; for Smart Printer; 1700 pieces on roll; stretchable 5 - 5.2 mm; plain; snap-on type; blue | www.wago.com/2009-145/000-006 |
|  | Item no.: 2009-145 Mini-WSB Inline; for Smart Printer; 1700 pieces on roll; stretchable 5 - 5.2 mm; plain; snap-on type; white | www.wago.com/2009-145 |
|  | Item no.: 2009-145/000-002 Mini-WSB Inline; for Smart Printer; 1700 pieces on roll; stretchable 5 - 5.2 mm; plain; snap-on type; yellow | www.wago.com/2009-145/000-002 |

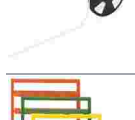
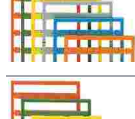
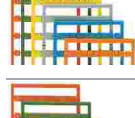
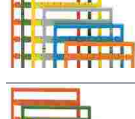
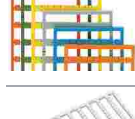
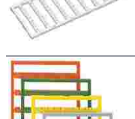
Subject to changes. Please also observe the further product documentation!

| | | |
|--|---|--|
|  | Item no.: 2009-145/000-007 Mini-WSB Inline; for Smart Printer; 1700 pieces on roll; stretchable 5 - 5.2 mm; plain; snap-on type; gray | www.wago.com/2009-145/000-007 |
|  | Item no.: 2009-145/000-005 Mini-WSB Inline; for Smart Printer; 1700 pieces on roll; stretchable 5 - 5.2 mm; plain; snap-on type; red | www.wago.com/2009-145/000-005 |
|  | Item no.: 2009-145/000-012 Mini-WSB Inline; for Smart Printer; 1700 pieces on roll; stretchable 5 - 5.2 mm; plain; snap-on type; orange | www.wago.com/2009-145/000-012 |
|  | Item no.: 2009-145/000-023 Mini-WSB Inline; for Smart Printer; 1700 pieces on roll; stretchable 5 - 5.2 mm; plain; snap-on type; green | www.wago.com/2009-145/000-023 |
|  | Item no.: 2009-145/000-024 Mini-WSB Inline; for Smart Printer; 1700 pieces on roll; stretchable 5 - 5.2 mm; plain; snap-on type; violet | www.wago.com/2009-145/000-024 |
|  | Item no.: 2009-115 WMB-Inline; for Smart Printer; 1500 pieces on roll; stretchable 5 - 5.2 mm; plain; snap-on type; white | www.wago.com/2009-115 |
|  | Item no.: 248-501/000-006 Mini-WSB marking card; as card; not stretchable; plain; snap-on type; blue | www.wago.com/248-501/000-006 |
|  | Item no.: 248-501/000-007 Mini-WSB marking card; as card; not stretchable; plain; snap-on type; gray | www.wago.com/248-501/000-007 |
|  | Item no.: 248-501/000-002 Mini-WSB marking card; as card; not stretchable; plain; snap-on type; yellow | www.wago.com/248-501/000-002 |
|  | Item no.: 248-501/000-012 Mini-WSB marking card; as card; not stretchable; plain; snap-on type; orange | www.wago.com/248-501/000-012 |
|  | Item no.: 248-501 Mini-WSB marking card; as card; not stretchable; plain; snap-on type; white | www.wago.com/248-501 |
|  | Item no.: 248-501/000-017 Mini-WSB marking card; as card; not stretchable; plain; snap-on type; light green | www.wago.com/248-501/000-017 |

Subject to changes. Please also observe the further product documentation!



Item no.: 248-501/000-005
Mini-WSB marking card; as card; not stretchable; plain; snap-on type; red

www.wago.com/248-501/000-005



Item no.: 248-501/000-024
Mini-WSB marking card; as card; not stretchable; plain; snap-on type; violet

www.wago.com/248-501/000-024



Item no.: 248-501/000-023
Mini-WSB marking card; as card; not stretchable; plain; snap-on type; green

www.wago.com/248-501/000-023



Item no.: 793-5501/000-007
WMB marking card; as card; for terminal block width 5 - 17.5 mm; stretchable 5 - 5.2 mm; plain; snap-on type; gray

www.wago.com/793-5501/000-007



Item no.: 793-5501/000-012
WMB marking card; as card; for terminal block width 5 - 17.5 mm; stretchable 5 - 5.2 mm; plain; snap-on type; orange

www.wago.com/793-5501/000-012



Item no.: 793-5501/000-017
WMB marking card; as card; for terminal block width 5 - 17.5 mm; stretchable 5 - 5.2 mm; plain; snap-on type; light green

www.wago.com/793-5501/000-017



Item no.: 793-5501/000-023
WMB marking card; as card; for terminal block width 5 - 17.5 mm; stretchable 5 - 5.2 mm; plain; snap-on type; green

www.wago.com/793-5501/000-023



Item no.: 793-5501/000-024
WMB marking card; as card; for terminal block width 5 - 17.5 mm; stretchable 5 - 5.2 mm; plain; snap-on type; violet

www.wago.com/793-5501/000-024



Item no.: 793-501/000-002
WMB marking card; as card; not stretchable; plain; snap-on type; yellow

www.wago.com/793-501/000-002



Item no.: 793-501/000-007
WMB marking card; as card; not stretchable; plain; snap-on type; gray

www.wago.com/793-501/000-007

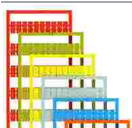

Item no.: 793-501/000-017
WMB marking card; as card; not stretchable; plain; snap-on type; light green

www.wago.com/793-501/000-017

Subject to changes. Please also observe the further product documentation!



Item no.: 793-501/000-012
WMB marking card; as card; not stretchable; plain; snap-on type; orange

www.wago.com/793-501/000-012



Item no.: 793-501/000-023
WMB marking card; as card; not stretchable; plain; snap-on type; green

www.wago.com/793-501/000-023



Item no.: 793-501/000-006
WMB marking card; as card; not stretchable; plain; snap-on type; blue

www.wago.com/793-501/000-006



Item no.: 793-501/000-005
WMB marking card; as card; not stretchable; plain; snap-on type; red

www.wago.com/793-501/000-005



Item no.: 793-501
WMB marking card; as card; not stretchable; plain; snap-on type; white

www.wago.com/793-501



Item no.: 793-501/000-024
WMB marking card; as card; not stretchable; plain; snap-on type; violet

www.wago.com/793-501/000-024



Item no.: 793-5501/000-005
WMB marking card; as card; for terminal block width 5 - 17.5 mm; stretchable 5 - 5.2 mm; plain; snap-on type; red

www.wago.com/793-5501/000-005



Item no.: 793-5501/000-002
WMB marking card; as card; for terminal block width 5 - 17.5 mm; stretchable 5 - 5.2 mm; plain; snap-on type; yellow

www.wago.com/793-5501/000-002



Item no.: 793-5501/000-006
WMB marking card; as card; for terminal block width 5 - 17.5 mm; stretchable 5 - 5.2 mm; plain; snap-on type; blue

www.wago.com/793-5501/000-006



Item no.: 793-5501
WMB marking card; as card; for terminal block width 5 - 17.5 mm; stretchable 5 - 5.2 mm; plain; snap-on type; white













www.wago.com/793-5501



Item no.: 2009-115/000-012
WMB-Inline; for Smart Printer; 1500 pieces on roll; stretchable 5 - 5.2 mm; plain; snap-on type; orange

www.wago.com/2009-115/000-012

Subject to changes. Please also observe the further product documentation!

| | | |
|--|--|--|
|  | Item no.: 2009-115/000-006 WMB-Inline; for Smart Printer; 1500 pieces on roll; stretchable 5 - 5.2 mm; plain; snap-on type; blue | www.wago.com/2009-115/000-006 |
| Group marker carrier | | |
|  | Item no.: 249-105 Group marker carrier; gray | www.wago.com/249-105 |
| Mounting | | |
| Cover carrier | | |
|  | Item no.: 709-167 Cover carrier; Type 1; incl. fixing/retaining screws and knurled nut; suitable for 279 to 282 and 880 Series rail-mounted terminal blocks; suitable for 264 Series miniature rail-mounted terminal blocks; suitable for 270 Series sensor and actuator terminal blocks; gray | www.wago.com/709-167 |
| Cover | | |
|  | Item no.: 709-153 Cover; Type 1; suitable for cover carrier, type 1; 1 m long; transparent | www.wago.com/709-153 |
| Mounting accessories | | |
|  | Item no.: 209-106 Mounting carrier; for isolated mounting on DIN 35 rails; gray | www.wago.com/209-106 |
|  | Item no.: 249-116 Screwless end stop; 6 mm wide; for DIN-rail 35 x 15 and 35 x 7.5; gray | www.wago.com/249-116 |
| Testing and measuring | | |
| Testing accessories | | |
|  | Item no.: 209-170 Test plug adapter; 8.3 mm wide; for 4 mm Ø test plugs; suitable for 1.5 mm ² - 10 mm ² tbs; gray | www.wago.com/209-170 |
|  | Item no.: 210-136 Test plug; 2 mm Ø; with 500 mm cable; red | www.wago.com/210-136 |
|  | Item no.: 281-407 Test plug; 6 mm wide; Nominal current 24 A; for 0.08 mm ² - 2.5 mm ² ; 2,50 mm ² ; gray | www.wago.com/281-407 |
|  | Item no.: 249-106 B-type test plug module; modular; 1,50 mm ² ; gray | www.wago.com/249-106 |
|  | Item no.: 249-107 B-type spacer module; modular; e.g., for bridging commoned terminal blocks; gray | www.wago.com/249-107 |
|  | Item no.: 280-418 Test plug module; modular; suitable for all WAGO 280 and 780 Series rail-mounted terminal blocks with jumper slots in the current bar; gray | www.wago.com/280-418 |
|  | Item no.: 280-404 | |

Subject to changes. Please also observe the further product documentation!

Test plug adapter; 5 mm wide; for test plug (2.3 mm Ø); suitable for 1.5 mm² - 4 mm² tbs; gray

www.wago.com/280-404



Item no.: 280-419

Spacer module; modular; bridging commoned terminal blocks; gray

www.wago.com/280-419

Protective warning marker

Cover



Item no.: 280-415

Protective warning marker; for 5 terminal blocks; with high-voltage symbol, black; yellow

www.wago.com/280-415

Carrier rail

Mounting accessories



Item no.: 210-197

Steel carrier rail; 35 x 15 mm; 1.5 mm thick; 2 m long; slotted; similar to EN 60715; silver-colored

www.wago.com/210-197



Item no.: 210-198

Copper carrier rail; 35 x 15 mm; 2.3 mm thick; 2 m long; unslotted; according to EN 60715; copper-colored

www.wago.com/210-198



Item no.: 210-504

Steel carrier rail; 35 x 7.5 mm; 1 mm thick; 2 m long; slotted; galvanized; according to EN 60715; silver-colored

www.wago.com/210-504



Item no.: 210-505

Steel carrier rail; 35 x 7.5 mm; 1 mm thick; 2 m long; unslotted; galvanized; according to EN 60715; silver-colored

www.wago.com/210-505



Item no.: 210-506

Steel carrier rail; 35 x 15 mm; 1.5 mm thick; 2 m long; unslotted; galvanized; similar to EN 60715; silver-colored

www.wago.com/210-506



Item no.: 210-508

Steel carrier rail; 35 x 15 mm; 1.5 mm thick; 2 m long; slotted; galvanized; similar to EN 60715; silver-colored

www.wago.com/210-508

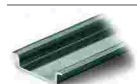

Item no.: 210-113

Steel carrier rail; 35 x 7.5 mm; 1 mm thick; 2 m long; unslotted; according to EN 60715; silver-colored

www.wago.com/210-113

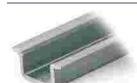

Item no.: 210-118

Steel carrier rail; 35 x 15 mm; 2.3 mm thick; 2 m long; unslotted; according to EN 60715; silver-colored

www.wago.com/210-118



Item no.: 210-112

Steel carrier rail; 35 x 7.5 mm; 1 mm thick; 2 m long; slotted; according to EN 60715; "Hole width 25 mm; silver-colored

www.wago.com/210-112



Item no.: 210-114

Steel carrier rail; 35 x 15 mm; 1.5 mm thick; 2 m long; unslotted; similar to EN 60715; silver-colored

www.wago.com/210-114



Item no.: 210-115

Steel carrier rail; 35 x 7.5 mm; 1 mm thick; 2 m long; slotted; according to EN 60715; "Hole width 18 mm; silver-colored

www.wago.com/210-115

Subject to changes. Please also observe the further product documentation!

WAGO GmbH & Co. KG

Hansastr. 27

32423 Minden

Phone: +49571 887-0 | Fax: +49571 887-169

Email: info.de@wago.com | Web: www.wago.com

Do you have any questions about our products?

We are always happy to take your call at +49 (571) 887-44222.



Item no.: 210-196

Aluminum carrier rail; 35 x 8.2 mm; 1.6 mm thick; 2 m long; unslotted; similar to EN 60715; silver-colored

www.wago.com/210-196

End plate

End plate



Item no.: 880-345

Separator plate; 2 mm thick; oversized; gray

www.wago.com/880-345



Item no.: 880-347

Separator plate; 2 mm thick; oversized; orange

www.wago.com/880-347

Push-in type wire jumper

Jumper



Item no.: 249-123

Push-in type wire jumper; 0.75 mm²; insulated; 180 mm long; black

www.wago.com/249-123



Item no.: 249-126

Push-in type wire jumper; 0.75 mm²; insulated; 110 mm long; black

www.wago.com/249-126



Item no.: 249-127

Push-in type wire jumper; 0.75 mm²; insulated; 250 mm long; black

www.wago.com/249-127



Item no.: 249-125

Push-in type wire jumper; insulated; 60 mm long; black

www.wago.com/249-125

Downloads

Documentation

Additional Information

Technical Section

pdf

Download

Technical explanations

2.2 MB

CAD/CAE-Data

CAD data

2D/3D Models 880-832

URL

Download

CAE data

EPLAN Data Portal 880-832

URL

Download

ZUKEN Portal 880-832

URL

Download

WSCAD Universe 880-832

URL

Download

Subject to changes. Please also observe the further product documentation!

WAGO GmbH & Co. KG

Hansastr. 27

32423 Minden

Phone: +49571 887-0 | Fax: +49571 887-169

Email: info.de@wago.com | Web: www.wago.com

Do you have any questions about our products?

We are always happy to take your call at +49 (571) 887-44222.

Environmental Product Compliance

Compliance Search

Environmental Product Compliance 880-832

URL

Download

4-conductor through terminal block; 4 mm²; with test port; without shield contact; center marking; for DIN-rail 35 x 15 and 35 x 7.5; CAGE CLAMP®; 4,00 mm²; orange

Installation Notes

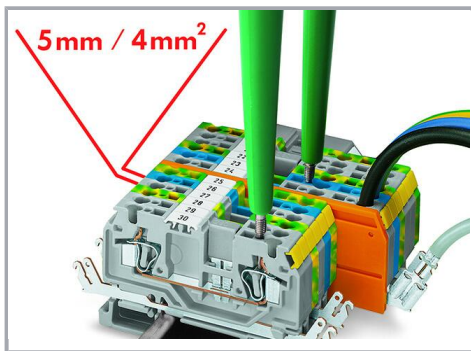

Features

- 2-, 3- and 4-conductor terminal blocks, just 5 mm wide
- Conductor cross-sections up to 4 mm² (per VDE 0281) or 12 AWG with ferrule (Item No. 216-206) 2.5 mm² rubber-insulated conductors with outer diameter up to 4.4 mm
- Shield contact via 6.3 (2 x 2.8) mm solder/crimp quick disconnect terminal
- Test plug, red, 2 mm Ø
- WMB markers
- Mini-WSB markers, on both sides
- Commoning with WAGO jumper systems

Conductor termination

Subject to changes. Please also observe the further product documentation!

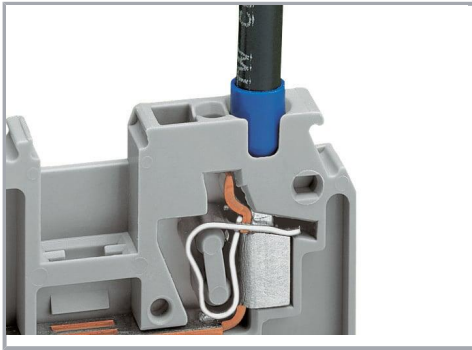

Using a 12 AWG conductor with ferrule (Item No. 216-206).

Testing

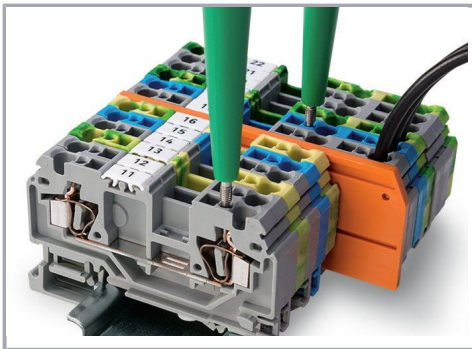

880 Series Terminal Blocks have an additional test slot for voltage tester.

Product family

Classic

EPSITRON® CLASSIC POWER: The Robust Power Supply – with Integrated TopBoost (Optional)

[Show all products from the family](#)

Subject to changes. Please also observe the further product documentation!