

Counter nut - A-INL-PG21-P-BK - 1424563

Please be informed that the data shown in this PDF Document is generated from our Online Catalog. Please find the complete data in the user's documentation. Our General Terms of Use for Downloads are valid (<http://phoenixcontact.com/download>)

Counter nut, material: PA 6 GF 30, connecting thread: Pg21, color: jet black RAL 9005



Key Commercial Data

Packing unit	5 pc
GTIN	
GTIN	4055626374673

Technical data

Dimensions

Length	7 mm
Connecting thread diameter	28.3 mm
Wrench size, counter nut	36 mm
Hexagon angular dimension	39 mm

Ambient conditions

Ambient temperature (operation)	-40 °C ... 100 °C
---------------------------------	-------------------

General

Material	PA 6 GF 30
Flammability rating according to UL 94	V2
Thread type connection side	Pg21
Thread type on connection side	Pg21
Color	jet black RAL 9005

Standards and Regulations

Halogen-free	yes
Flammability rating according to UL 94	V2

Environmental Product Compliance

Counter nut - A-INL-PG21-P-BK - 1424563

Technical data

Environmental Product Compliance

China RoHS	Environmentally friendly use period: unlimited = EFUP-e
	No hazardous substances above threshold values

Drawings

Dimensional drawing

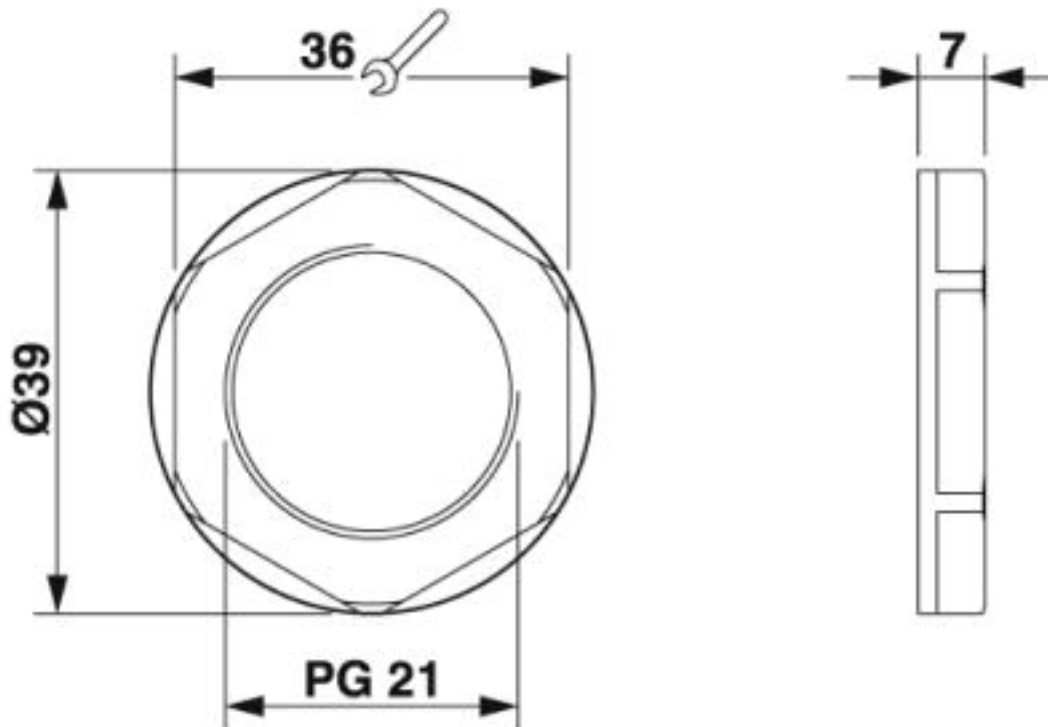

Phoenix Contact 2019 © - all rights reserved
<http://www.phoenixcontact.com>

PHOENIX CONTACT GmbH & Co. KG
Flachsmarktstr. 8
32825 Blomberg
Germany
Tel. +49 5235 300
Fax +49 5235 3 41200
<http://www.phoenixcontact.com>