

02310QDT-C-C

Huawei 02310QDT-C (SFP-10G-BXD) Compatible TAA 10GBase-BX SFP+ Transceiver (SMF, 1330nmTx/1270nmRx, 10km, LC, DOM)

Features:

- SFF-8432 and SFF-8472 Compliance
- Simplex LC Connector
- Uncooled DFB transmitter and PIN receiver
- Single-mode Fiber
- Commercial Temperature 0 to 70 Celsius
- Hot Pluggable
- Metal with Lower EMI
- Excellent ESD Protection
- RoHS Compliant and Lead Free

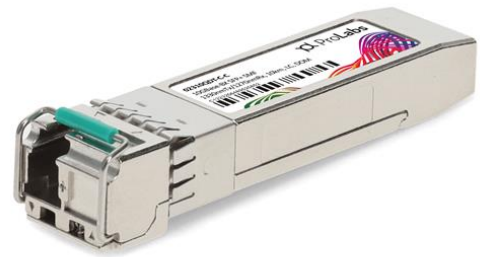

Applications:

- 10GBase-BX Ethernet
- 8x/10x Fibre Channel
- Access, Metro and Enterprise

Product Description

This Huawei® SFP+ transceiver provides 10GBase-BX throughput up to 10km over single-mode fiber (SMF) using a wavelength of 1330nmTx/1270nmRx via an LC connector. It is guaranteed to be 100% compatible with the equivalent Huawei® transceiver. This easy to install, hot swappable transceiver has been programmed, uniquely serialized and data-traffic and application tested to ensure that it will initialize and perform identically. Digital optical monitoring (DOM) support is also present to allow access to real-time operating parameters. This transceiver is Trade Agreements Act (TAA) compliant. We stand behind the quality of our products and proudly offer a limited lifetime warranty.

ProLabs's transceivers are RoHS compliant and lead-free.

TAA refers to the Trade Agreements Act (19 U.S.C. & 2501-2581), which is intended to foster fair and open international trade. TAA requires that the U.S. Government may acquire only "U.S. – made or designated country end products."



Regulatory Compliance

- ESD to the Electrical PINs: compatible with MIL-STD-883E Method 3015.4.
- ESD to the LC Receptacle: compatible with IEC 61000-4-3.
- EMI/EMC: compatible with FCC Part 15 Subpart B Rules, EN55022:2010.
- Laser Eye Safety: compatible with FDA 21CFR, EN60950-1& EN (IEC) 60825-1, 2.
- RoHS: compliant with EU RoHS 2.0 directive 2015/863/EU.

Absolute Maximum Ratings

| Parameter | Symbol | Min. | Typ. | Max. | Unit | Notes |
|----------------------------|--------|------|------|-------------------|------|-------|
| Maximum Supply Voltage | Vcc | -0.5 | | 4.0 | V | 1 |
| Storage Temperature | Tstg | -40 | | 85 | °C | 2 |
| Operating Case Temperature | Tc | 0 | | 70 | °C | 3 |
| Data Rate | DR | 9.83 | | 11.3 | Gbps | 4 |
| Bit Error Rate | BER | | | 10 ⁻¹² | | |
| Supply Current | Icc | | 200 | 350 | mA | 1 |

Notes:

1. For electrical power interface.
2. Ambient temperature.
3. Case Temperature.
4. IEEE 802.3ae.

Electrical Characteristics

| Parameter | Symbol | Min. | Typ. | Max. | Unit | Notes |
|--|-------------------|------|------|----------|------|-------|
| Power Supply Voltage | Vcc | 3.14 | 3.3 | 3.46 | V | |
| Power Dissipation | P _{DISS} | | 0.65 | 1.2 | W | |
| Transmitter | | | | | | |
| Input Differential Impedance | RIN | | 100 | | Ω | |
| Differential Data Input Swing | VIN,pp | 180 | | 700 | mV | |
| Transmit Disable Voltage | VD | 2.0 | | Vcc | V | |
| Transmit Enable Voltage | VEN | Vee | | Vee+0.8 | V | |
| Receiver | | | | | | |
| Differential Data Output Swing | VOUT,pp | 300 | | 850 | mV | |
| Data Output Rise Time/Fall Time (20-80%) | Tr/Tf | 28 | | | ps | |
| LOS Assert | LOSA | 2 | | Host_Vcc | V | |
| LOS De-Assert | LOSD | Vee | | Vee+0.5 | V | |

Optical Characteristics

| Parameter | Symbol | Min. | Typ. | Max. | Unit | Notes |
|---------------------------------|---------------------------------------|------|------|-------|-------|-------|
| Transmitter | | | | | | |
| Output Optical Power | Ptx | -8.2 | | 0.5 | dBm | 1 |
| Optical Center Wavelength | λ_C | 1320 | 1330 | 1340 | nm | |
| Extinction Ratio | ER | 3.5 | | | dB | |
| Spectral Width (-20dB) | $\Delta\lambda$ | | | 0.6 | nm | |
| Side-Mode Suppression Ratio | SMSR | 30 | | | dB | |
| Relative Intensity Noise | RIN | | | -128 | dB/Hz | |
| Transmitter Dispersion Penalty | TDP | | | 3.2 | dB | |
| Launch Power of Off Transmitter | Poff | | | -30 | dBm | 1 |
| Transmitter Jitter | According to IEEE 802.3ae Requirement | | | | | |
| Receiver | | | | | | |
| Receiver Overload | | 0.5 | | | dBm | |
| Optical Center Wavelength | λ_C | 1260 | 1270 | 1280 | nm | |
| Receiver Sensitivity | S | | | -14.4 | dBm | 2 |
| Receiver Reflectance | TRrx | | | -12 | dB | |
| LOS Assert | LOSA | -30 | | | dBm | |
| LOS De-Assert | LOSD | | | -17 | dBm | |
| LOS Hysteresis | LOSH | 0.5 | | | dB | |

Notes:

1. Average.
2. Average. Measured with worst ER: BER < 10^{-12} and $2^{31}-1$ PRBS.

Pin Descriptions

| Pin | Symbol | Name/Descriptions | Notes |
|-----|------------|--|-------|
| 1 | VeeT | Transmitter Ground. Common with receiver ground. | 1 |
| 2 | Tx_Fault | Transmitter Fault. | 2 |
| 3 | Tx_Disable | Transmitter Disable. Laser output disabled on "high" or "open." | 3 |
| 4 | SDA | 2-Wire Serial Interface Data. | 4 |
| 5 | SCL | 2-Wire Serial Interface Clock. | 4 |
| 6 | MOD_ABS | Module Absent. Grounded within the module. | 4 |
| 7 | RS0 | No connection required. | |
| 8 | LOS | Loss of Signal indication. "Logic 0" indicates normal operation. | 5 |
| 9 | RS1 | No connection required. | 1 |
| 10 | VeeR | Receiver Ground. Common with transmitter ground. | 1 |
| 11 | VeeR | Receiver Ground. Common with transmitter ground. | 1 |
| 12 | RD- | Receiver Inverted Data Out. AC coupled. | |
| 13 | RD+ | Receiver Non-Inverted Data Out. AC coupled. | |
| 14 | VeeR | Receiver Ground. Common with transmitter ground. | 1 |
| 15 | VccR | Receiver Power Supply. | |
| 16 | VccT | Transmitter Power Supply. | |
| 17 | VeeT | Transmitter Ground. Common with receiver ground. | 1 |
| 18 | TD+ | Transmitter Non-Inverted Data In. AC coupled. | |
| 19 | TD- | Transmitter Inverted Data In. AC coupled. | |
| 20 | VeeT | Transmitter Ground. Common with receiver ground. | 1 |

Notes:

1. Circuit ground is isolated from the chassis ground.
2. Tx_Fault is the open collector output and should be pulled up with 4.7k Ω -10k Ω on the host board to a voltage between 2V and Vcc+0.3V.
3. Disabled: TDIS>2V or open. Enabled TDIS<0.8V.
4. Should be pulled up with the 4.7k Ω -10k Ω on the host board to a voltage between 2V and Vcc+0.3V.
5. LOS is open collector output and should be pulled with 4.7k Ω -10k Ω on the host board to a voltage between 2V and Vcc+0.3V. The logic "0" indicated normal operation, and the logic "1" indicates that the receiver signal is lost.

Transceiver Block Diagram

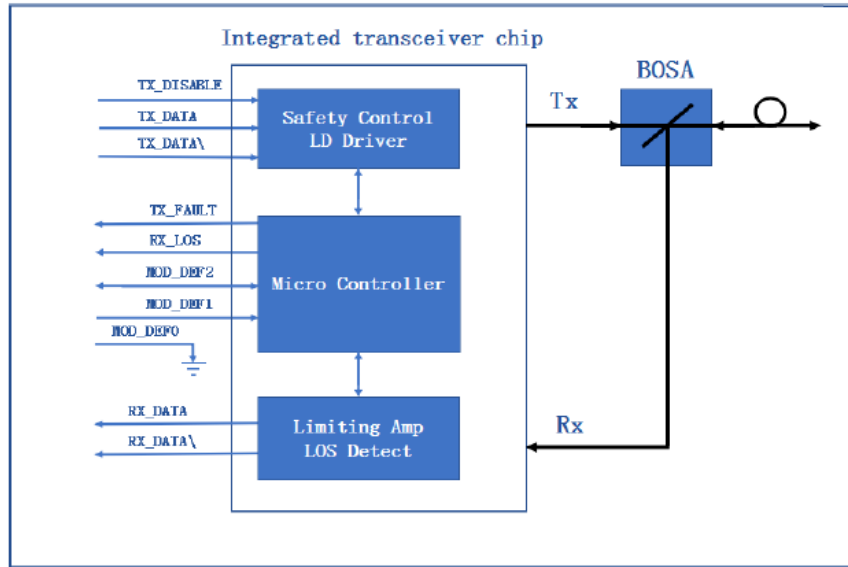

Electical Pad Layout

Top view

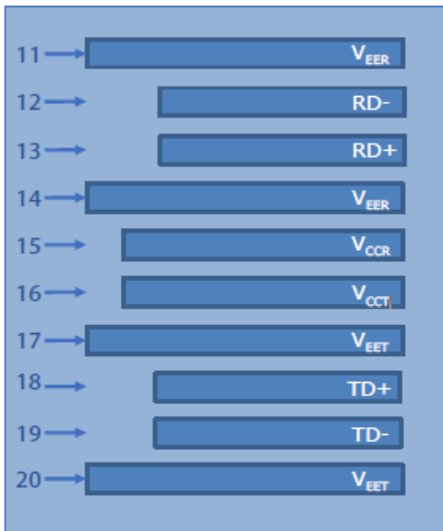

Bottom view

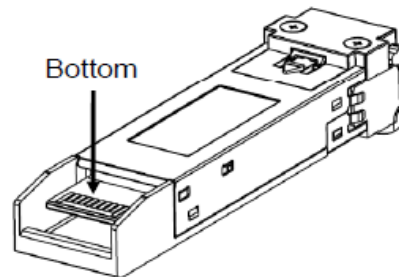
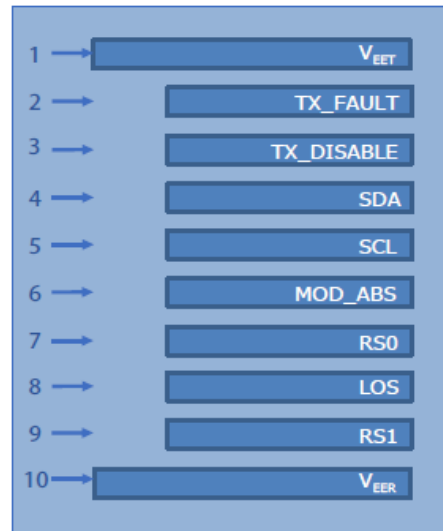

Mechanical Specifications

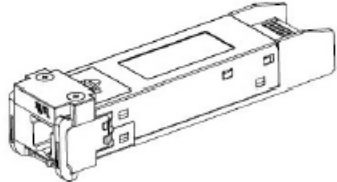
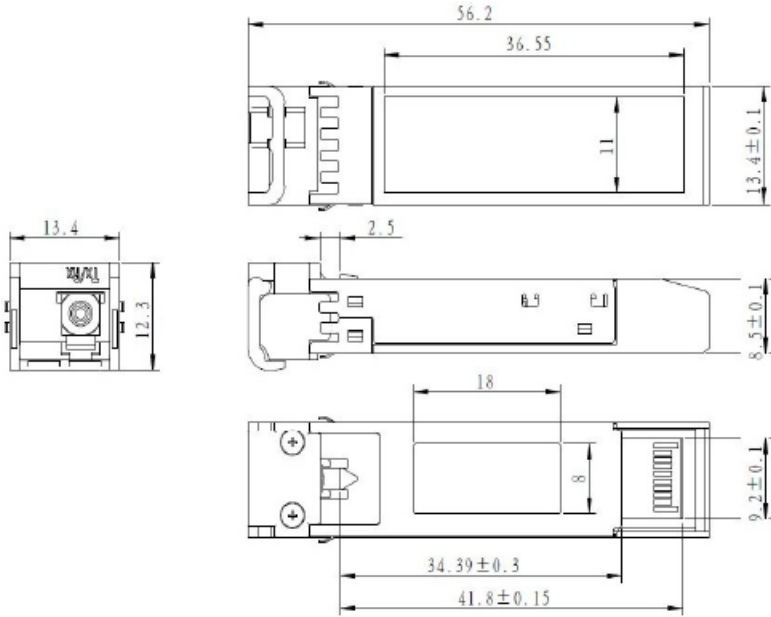

LATCHED

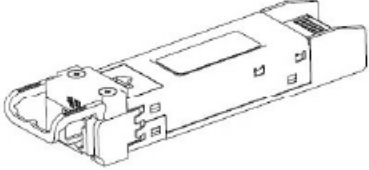

UNLATCHED

About ProLabs

Our experience comes as standard; for over 15 years ProLabs has delivered optical connectivity solutions that give our customers freedom and choice through our ability to provide seamless interoperability. At the heart of our company is the ability to provide state-of-the-art optical transport and connectivity solutions that are compatible with over 90 optical switching and transport platforms.

Complete Portfolio of Network Solutions

ProLabs is focused on innovations in optical transport and connectivity. The combination of our knowledge of optics and networking equipment enables ProLabs to be your single source for optical transport and connectivity solutions from 100Mb to 400G while providing innovative solutions that increase network efficiency. We provide the optical connectivity expertise that is compatible with and enhances your switching and transport equipment.

Trusted Partner

Customer service is our number one value. ProLabs has invested in people, labs and manufacturing capacity to ensure that you get immediate answers to your questions and compatible product when needed. With Engineering and Manufacturing offices in the U.K. and U.S. augmented by field offices throughout the U.S., U.K. and Asia, ProLabs is able to be our customers best advocate 24 hours a day.

Contact Information

ProLabs US

Email: sales@prolabs.com

Telephone: 952-852-0252

ProLabs UK

Email: salessupport@prolabs.com

Telephone: +44 1285 719 600