

Optocoupler, Phototriac Output, 400 V_{DRM}

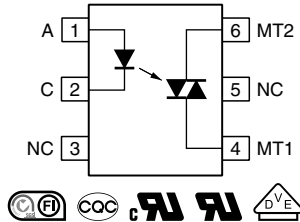

23043



FEATURES

- 400 V blocking voltage
- Isolation test voltage, 5000 V_{RMS}, t = 1 min
- Material categorization: for definitions of compliance please see www.vishay.com/doc?99912



RoHS
COMPLIANT
HALOGEN
FREE
GREEN
(5-2008)

APPLICATIONS

- High current triac driver
- Solid-state relay
- Switch small AC loads

AGENCY APPROVALS

- [UL](#)
- [cUL](#)
- [DIN EN 60747-5-5 \(VDE 0884-5\)](#), available with option "1"
- [CQC GB8898-2011](#)
- [CQC GB4943.1-2011](#)
- [FIMKO](#)

LINKS TO ADDITIONAL RESOURCES



3D Models



Design Tools



Related Documents



SPICE Models



Footprints



Schematics

DESCRIPTION

The VO302x series consists of a phototriac optically coupled to a gallium arsenide infrared-emitting diode in a 6-lead plastic dual inline package

ORDERING INFORMATION

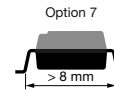
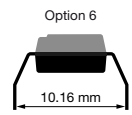
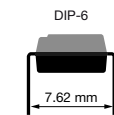
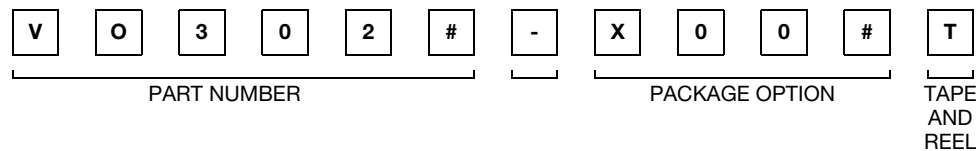

AGENCY CERTIFIED / PACKAGE	TRIGGER CURRENT, I _{FT}		
	5 mA	10 mA	15 mA
UL, cUL, CQC			
DIP-6	VO3023	-	-
DIP-6, 400 mil, option 6	-	-	VO3021-X006
VDE, UL, cUL, FIMKO, CQC			
DIP-6	VO3023-X001	VO3022-X001	-
SMD-6, option 7	VO3023-X017T	-	-

Note

- Additional options may be possible, please contact sales office

ABSOLUTE MAXIMUM RATINGS ($T_{amb} = 25\text{ }^{\circ}\text{C}$, unless otherwise specified)				
PARAMETER	TEST CONDITION	SYMBOL	VALUE	UNIT
INPUT				
Reverse voltage		V_R	6	V
Forward current		I_F	50	mA
Peak surge current	100 μs , 200 pps	I_{FSM}	0.5	A
Power dissipation		P_{diss}	70	mW
OUTPUT				
Peak off-state voltage		V_{DRM}	400	V
RMS on-state current		$I_{T(RMS)}$	0.1	A
Peak non-repetitive surge current	PW = 100 ms, 120 pps	I_{TSM}	1	A
Power dissipation		P_{diss}	300	mW
COUPLER				
Total power dissipation		P_{diss}	330	mW
Storage temperature range		T_{stg}	-55 to +150	$^{\circ}\text{C}$
Ambient temperature		T_{amb}	-40 to +100	$^{\circ}\text{C}$
Lead soldering temperature	2 mm from case, $t < 10\text{ s}$	T_{sld}	260	$^{\circ}\text{C}$
Junction temperature		T_J	125	$^{\circ}\text{C}$

Note

- Stresses in excess of the absolute maximum ratings can cause permanent damage to the device. Functional operation of the device is not implied at these or any other conditions in excess of those given in the operational sections of this document. Exposure to absolute maximum ratings for extended periods of the time can adversely affect reliability

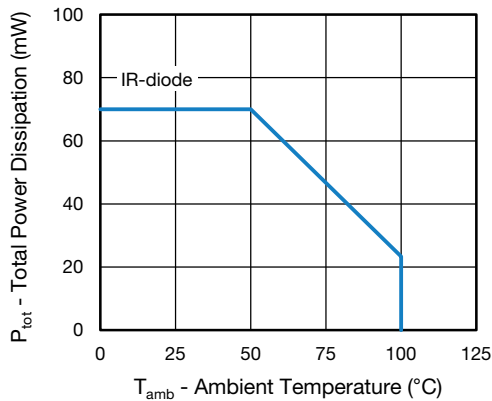

Fig. 1 - Total Power Dissipation vs. Ambient Temperature (IR diode)

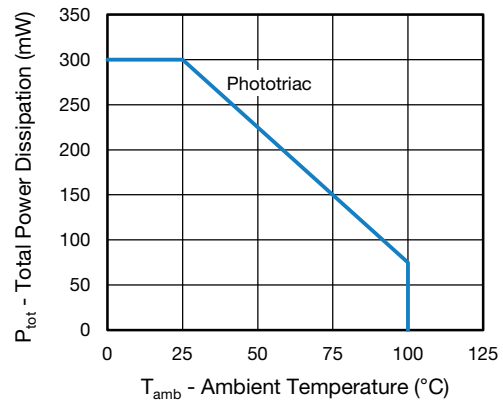

Fig. 2 - Total Power Dissipation vs. Ambient Temperature (Phototriac)



ELECTRICAL CHARACTERISTICS ($T_{amb} = 25\text{ }^{\circ}\text{C}$, unless otherwise specified)							
PARAMETER	TEST CONDITION	PART	SYMBOL	MIN.	TYP.	MAX.	UNIT
INPUT							
Forward voltage	$I_F = 20\text{ mA}$		V_F	-	1.3	1.5	V
Reverse voltage	$I_R = 10\text{ }\mu\text{A}$		V_R	6	-	-	V
Reverse current	$V_R = 6\text{ V}$		I_R	-	-	10	μA
Junction capacitance	$V_R = 0\text{ V}$, $f = 1\text{ MHz}$		C_j	-	50	-	pF
OUTPUT							
Peak off-state current, either direction	$V_{DRM} = 400\text{ V}^{(1)}$		I_{DRM}	-	10	100	nA
Peak off-state voltage, either direction	$I_{TM} = 100\text{ mA}$		V_{TM}	-	1.7	3	V
Critical rate of rise of off-state voltage	$I_F = 0\text{ A}$, $V_D = 0.67\text{ }V_{DRM}$		dV/dt_{cr}	100	-	-	V/ μs
COUPLER ⁽²⁾							
Emitting diode trigger current	$V_T = 3\text{ V}$, $R_L = 150\text{ }\Omega$	VO3021	I_{FT}	-	8	15	mA
		VO3022	I_{FT}	-	5	10	mA
		VO3023	I_{FT}	-	3	5	mA
Holding current	$I_F = 10\text{ mA}$, $V_T \geq 3\text{ V}$		I_H	-	200	-	μA

Notes

- Minimum and maximum values are testing requirements. Typical values are characteristics of the device and are the result of engineering evaluation. Typical values are for information only and are not part of the testing requirements

(1) Test voltage must be applied within dV/dt ratings

(2) I_{FT} is defined as a minimum trigger current

SAFETY AND INSULATION RATINGS			
PARAMETER		SYMBOL	UNIT
MAXIMUM SAFETY RATINGS			
Output safety power		P_{SO}	mW
Input safety current		I_{si}	mA
Safety temperature		T_S	$^{\circ}\text{C}$
Comparative tracking index		CTI	175
INSULATION RATED PARAMETERS			
Maximum withstanding isolation voltage		V_{ISO}	V_{RMS}
Maximum transient isolation voltage		V_{IOTM}	V_{peak}
Maximum repetitive peak isolation voltage		V_{IORM}	V_{peak}
		V_{IORM}	1140 ⁽¹⁾
Insulation resistance	$T_{amb} = 25\text{ }^{\circ}\text{C}$, $V_{DC} = 500\text{ V}$	R_{IO}	Ω
Isolation resistance	$T_{amb} = 100\text{ }^{\circ}\text{C}$, $V_{DC} = 500\text{ V}$	R_{IO}	Ω
Climatic classification (according to IEC 68 part 1)			55 / 115 / 21
Environment (pollution degree in accordance to DIN VDE 0109)			2
Creepage distance (standard DIP-6)			≥ 7 mm
Creepage distance (400 mil DIP-6)			≥ 8 mm
Clearance distance (standard DIP-6)			≥ 7 mm
Clearance distance (400 mil DIP-6)			≥ 8 mm
Insulation thickness		DTI	≥ 0.4 mm

Notes

- As per DIN EN 60747-5-5, § 7.4.3.8.2, this optocoupler is suitable for "safe electrical insulation" only within the safety ratings. Compliance with the safety ratings shall be ensured by means of protective circuits

(1) 400 mil, option 6 only

TYPICAL CHARACTERISTICS ($T_{amb} = 25\text{ }^{\circ}\text{C}$, unless otherwise specified)

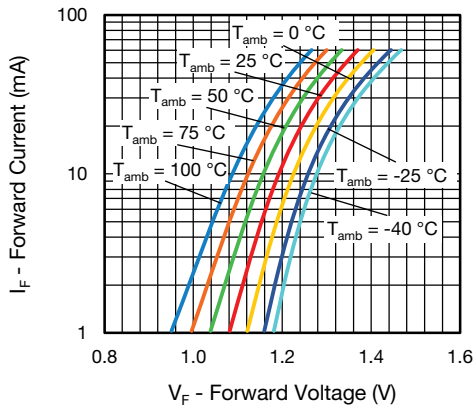

Fig. 3 - Forward Current vs. Forward Voltage

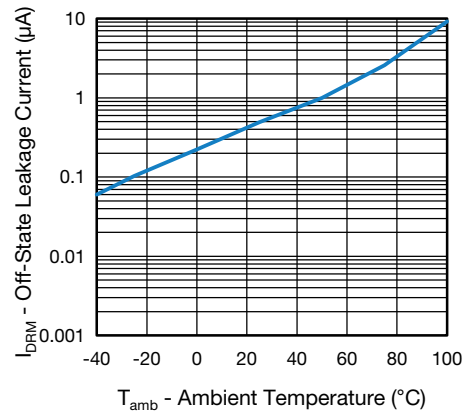

Fig. 6 - Off-State Leakage Current vs. Ambient Temperature

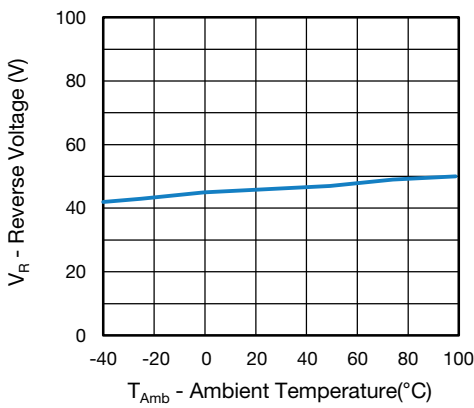

Fig. 4 - Reverse Voltage vs. Ambient Temperature

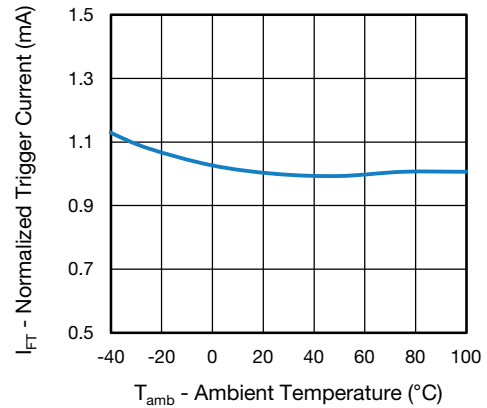

Fig. 7 - Normalized Trigger Current vs. Ambient Temperature

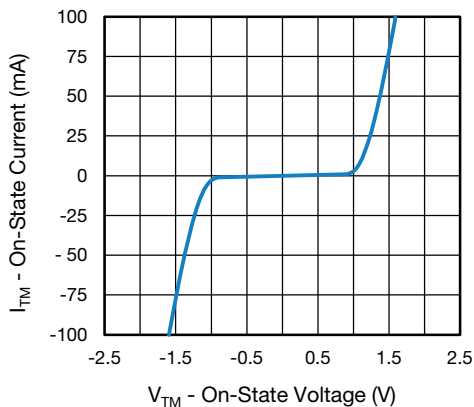

Fig. 5 - On-State Current vs. On-State Voltage

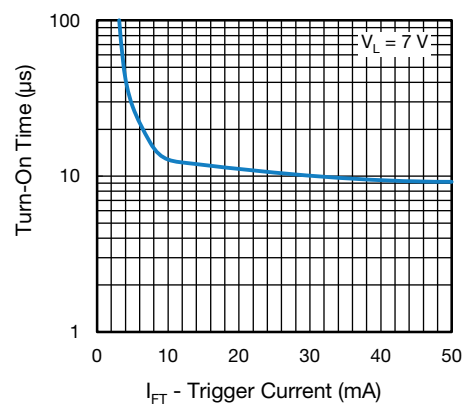

Fig. 8 - Turn-On Time vs. Trigger Current

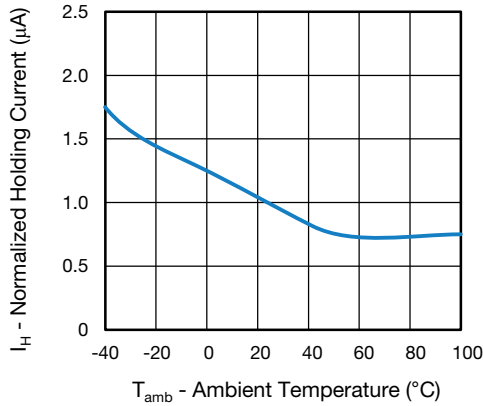

Fig. 9 - Normalized Holding Current vs. Ambient Temperature

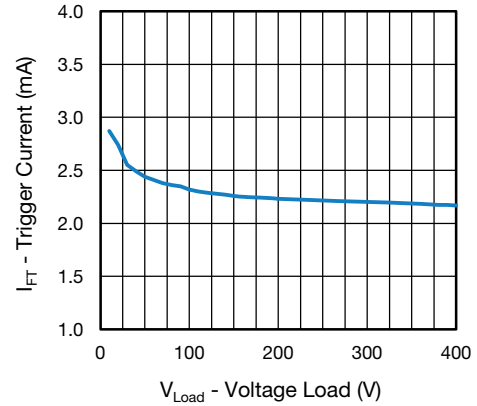

Fig. 12 - Trigger Current vs. Voltage Load

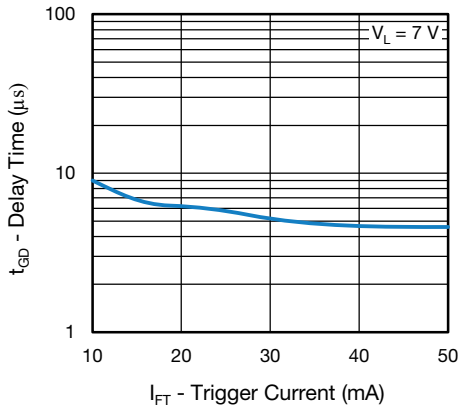

Fig. 10 - Delay Time vs. Trigger Current

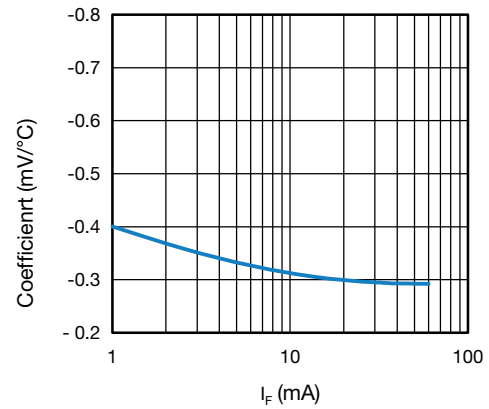

Fig. 13 - Coefficient vs. Forward Current

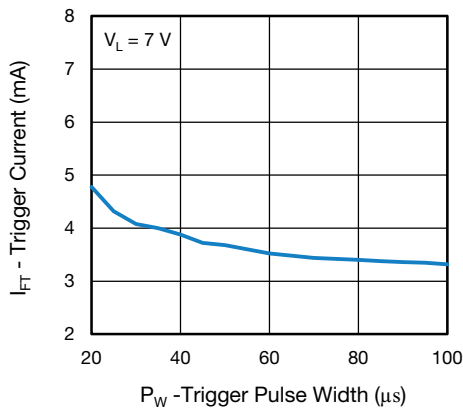

Fig. 11 - Trigger Current vs. Trigger Pulse Width

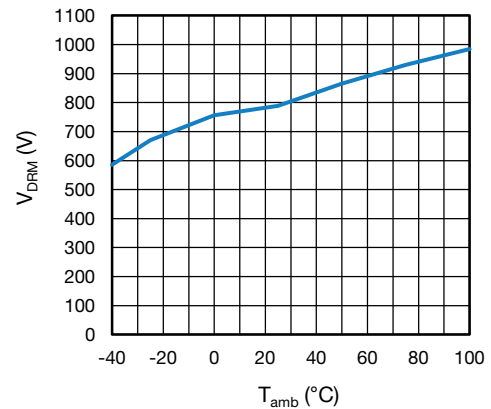

Fig. 14 - Peak Off-State Voltage vs. Ambient Temperature

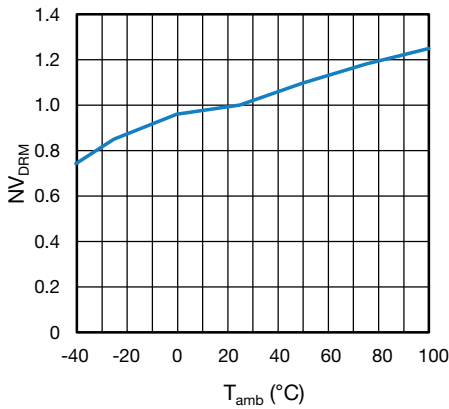

Fig. 15 - Normalized Off-State Voltage M2/M1 vs. Ambient Temperature

PACKAGE DIMENSIONS (in millimeters)

DIP-6

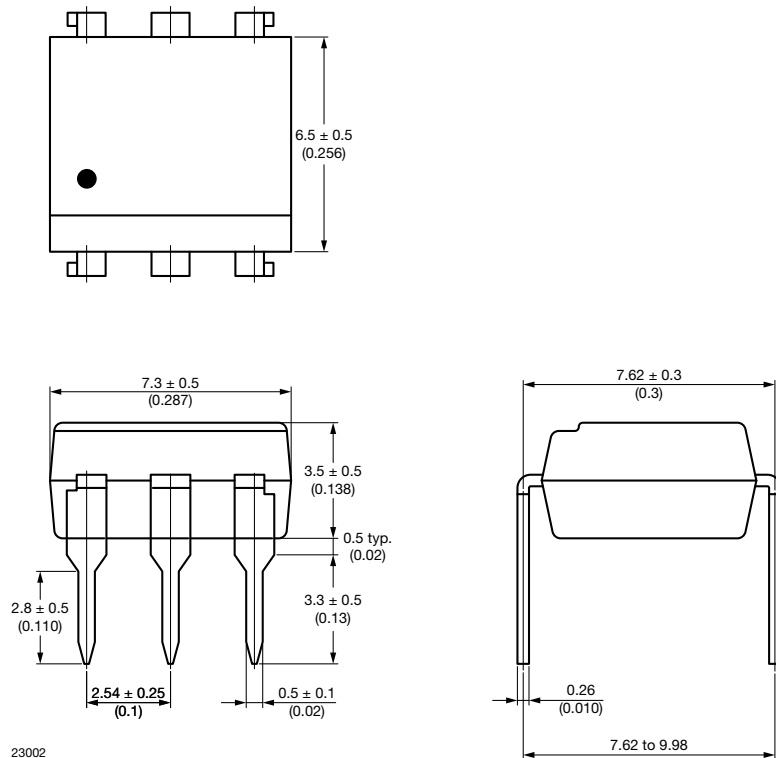

Fig. 1



DIP-6, 400 mil

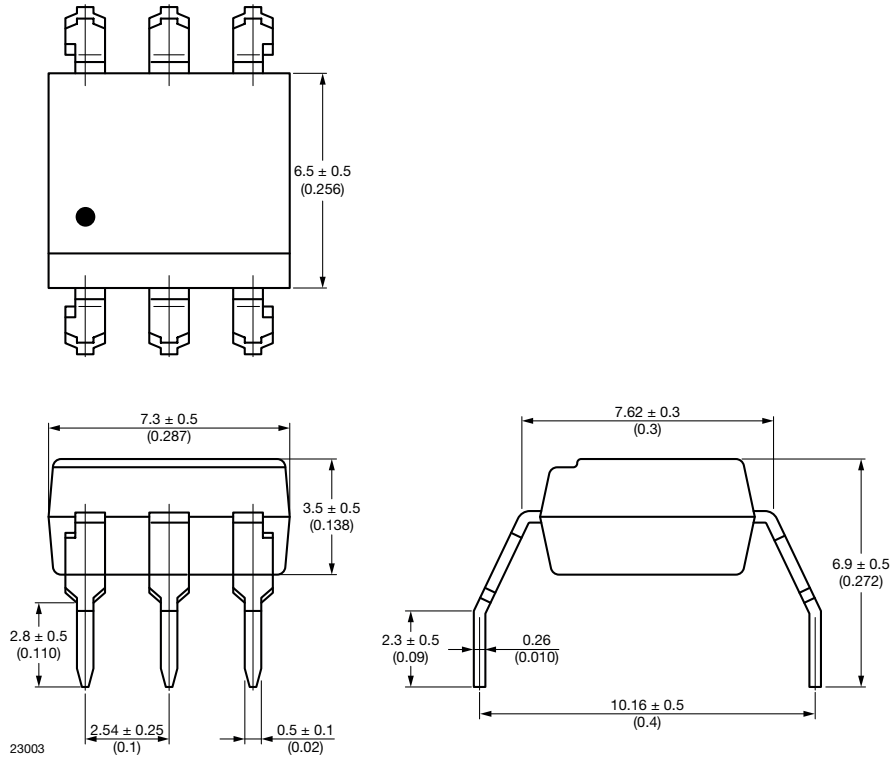

Fig. 2

SMD-6

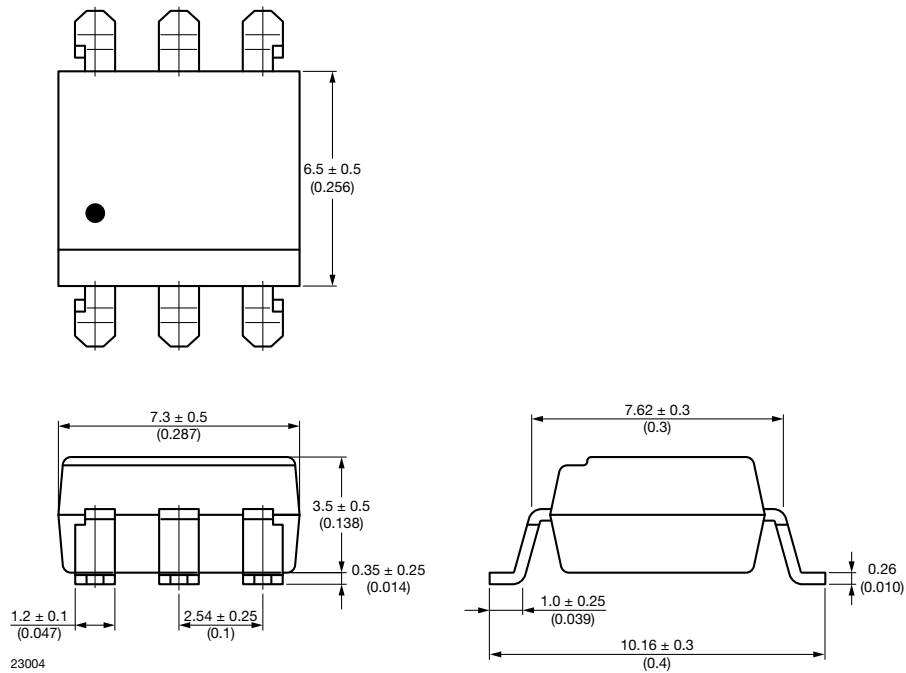

Fig. 3

PACKAGE MARKING

Fig. 16 - Example of VO3023-X017T

Notes

- “YWW” is the date code marking (Y = year code, WW = week code)
- VDE logo is only marked on VDE option parts
- Tape and reel suffix (T) is not part of the package marking

PACKING INFORMATION

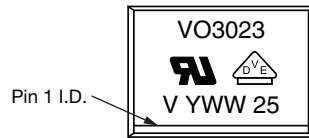
DEVICES PER TUBE			
TYPE	UNITS/TUBE	TUBES/BOX	UNITS/BOX
DIP-6	50	40	2000
DIP-6, 400 mil	50	40	2000

SMD-6 Tape

Fig. 17 - Tape and Reel Packaging (1000 pieces on reel)

Reel

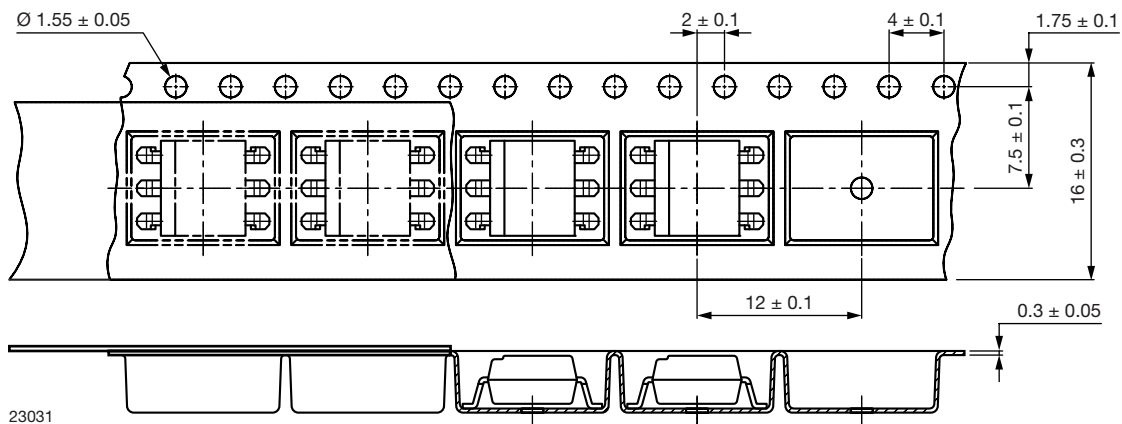
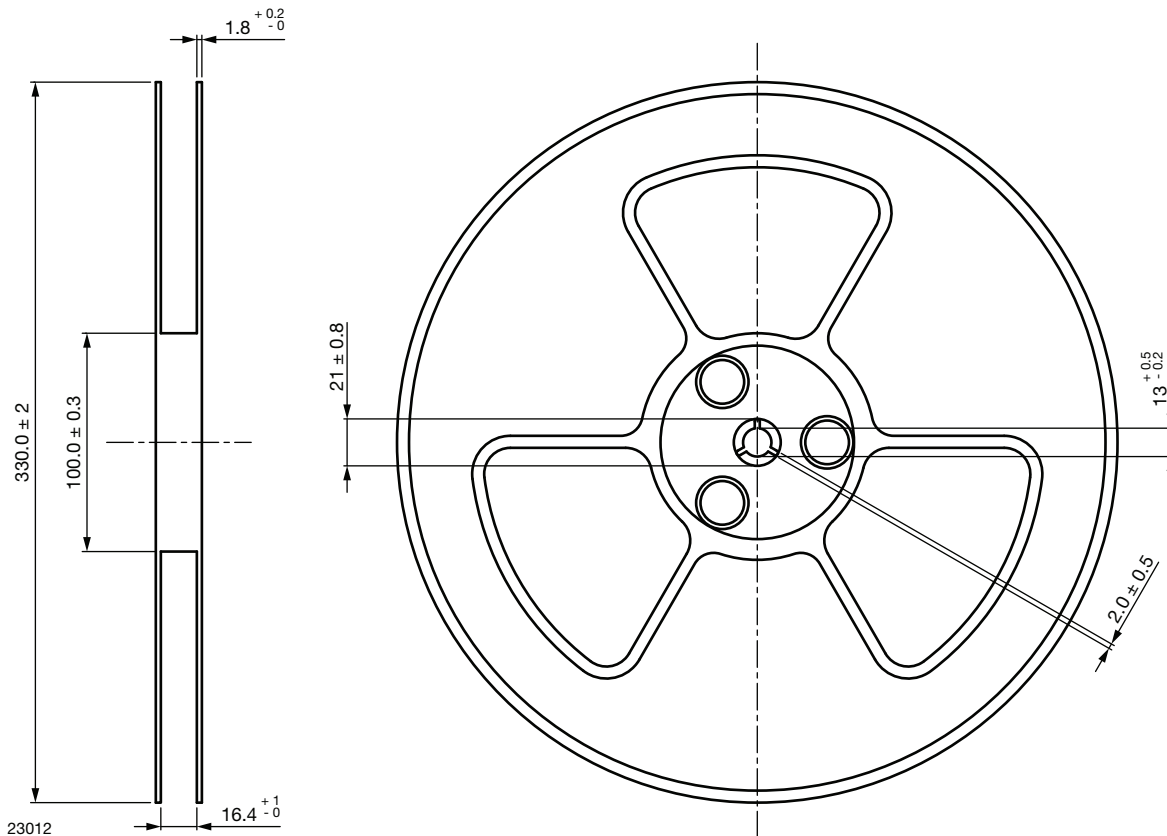

Fig. 18 - Tape and Reel Shipping Medium

REEL DIMENSIONS in millimeters

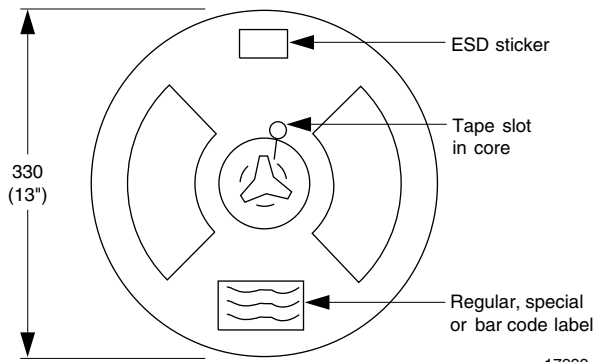

Fig. 19 - Reel Dimensions

SOLDER PROFILES
IR Reflow Soldering (JEDEC® J-STD-020C compliant)

One time soldering reflow is recommended within the condition of temperature and time profile shown below. Do not solder more than three times.

PROFILE ITEM	CONDITIONS
Preheat	
- Temperature minimum ($T_{S \text{ min.}}$)	150 °C
- Temperature maximum ($T_{S \text{ max.}}$)	200 °C
- Time (min. to max.) (t_S)	90 s ± 30 s
Soldering zone	
- Temperature (T_L)	217 °C
- Time (t_L)	60 s
Peak temperature (T_p)	260 °C
Ramp-up rate	3 °C/s max.
Ramp-down rate	3 °C/s to 6 °C/s

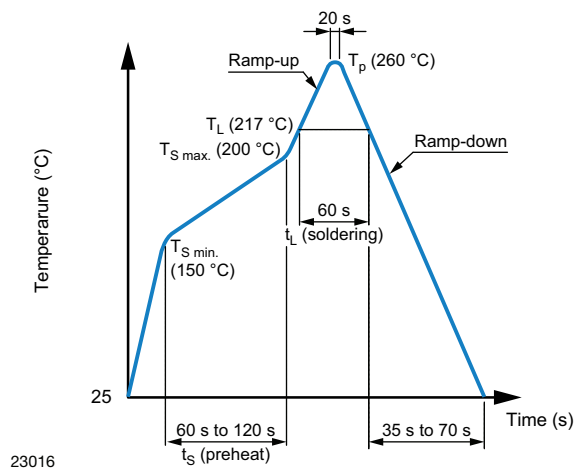

Fig. 4

Wave Soldering (JEDEC JESD22-A111 compliant)

One time soldering is recommended within the condition of temperature.

Temperature: 260 °C + 0 °C / - 5 °C

Time: 10 s

Preheat temperature: 25 °C to 140 °C

Preheat time: 30 s to 80 s

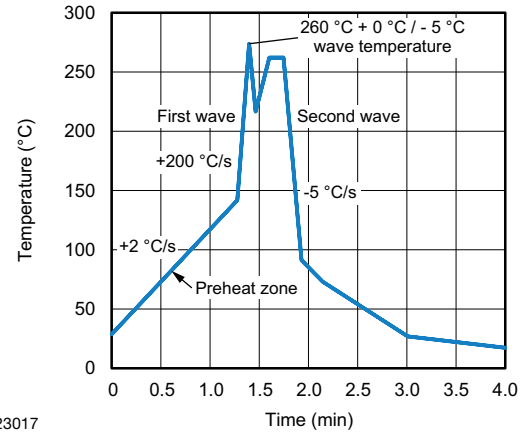

23017

Fig. 5

Hand Soldering by Soldering Iron

Allow single lead soldering in every single process. One time soldering is recommended.

Temperature: 380 °C + 0 °C / - 5 °C

Time: 3 s max.

HANDLING AND STORAGE CONDITIONS

ESD level: HBM class 2

Floor life: unlimited

Conditions: $T_{\text{amb}} < 30 \text{ °C}$, RH < 85 %

Moisture sensitivity level 1, according to J-STD-020



Disclaimer

ALL PRODUCT, PRODUCT SPECIFICATIONS AND DATA ARE SUBJECT TO CHANGE WITHOUT NOTICE TO IMPROVE RELIABILITY, FUNCTION OR DESIGN OR OTHERWISE.

Vishay Intertechnology, Inc., its affiliates, agents, and employees, and all persons acting on its or their behalf (collectively, "Vishay"), disclaim any and all liability for any errors, inaccuracies or incompleteness contained in any datasheet or in any other disclosure relating to any product.

Vishay makes no warranty, representation or guarantee regarding the suitability of the products for any particular purpose or the continuing production of any product. To the maximum extent permitted by applicable law, Vishay disclaims (i) any and all liability arising out of the application or use of any product, (ii) any and all liability, including without limitation special, consequential or incidental damages, and (iii) any and all implied warranties, including warranties of fitness for particular purpose, non-infringement and merchantability.

Statements regarding the suitability of products for certain types of applications are based on Vishay's knowledge of typical requirements that are often placed on Vishay products in generic applications. Such statements are not binding statements about the suitability of products for a particular application. It is the customer's responsibility to validate that a particular product with the properties described in the product specification is suitable for use in a particular application. Parameters provided in datasheets and / or specifications may vary in different applications and performance may vary over time. All operating parameters, including typical parameters, must be validated for each customer application by the customer's technical experts. Product specifications do not expand or otherwise modify Vishay's terms and conditions of purchase, including but not limited to the warranty expressed therein.

Hyperlinks included in this datasheet may direct users to third-party websites. These links are provided as a convenience and for informational purposes only. Inclusion of these hyperlinks does not constitute an endorsement or an approval by Vishay of any of the products, services or opinions of the corporation, organization or individual associated with the third-party website. Vishay disclaims any and all liability and bears no responsibility for the accuracy, legality or content of the third-party website or for that of subsequent links.

Except as expressly indicated in writing, Vishay products are not designed for use in medical, life-saving, or life-sustaining applications or for any other application in which the failure of the Vishay product could result in personal injury or death. Customers using or selling Vishay products not expressly indicated for use in such applications do so at their own risk. Please contact authorized Vishay personnel to obtain written terms and conditions regarding products designed for such applications.

No license, express or implied, by estoppel or otherwise, to any intellectual property rights is granted by this document or by any conduct of Vishay. Product names and markings noted herein may be trademarks of their respective owners.