

REVISIONS					
ZONE	LTR	ECO	DESCRIPTION	DATE	APPROVED
A		19891	RELEASED	7-8-75 MD	9-10-75
B		22368	DIM: 16:348 WAS: .365 NOTE 4: WAS: CONTACTS PER DWG. 096-0000-0024		8-5-77

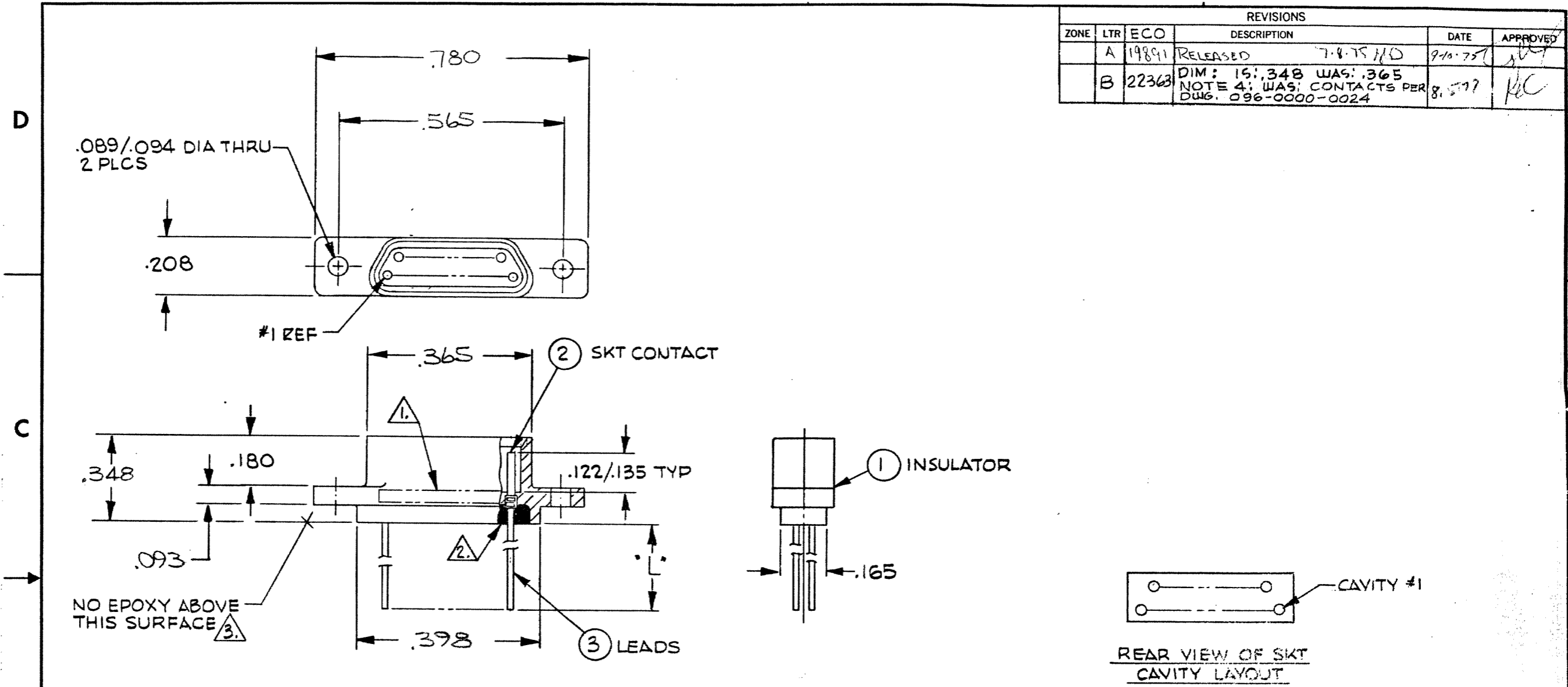

- NOTES:**
- 1. MARK "MALCO" OR MALCO LOGO PART NO. & DATE CODE WITH .047 MIN. HIGH CHARACTERS IN APPROX LOCATION SHOWN
 - 2. EPOXY AS SHOWN WITH HYSOL # 4215 AND # 3561
 - 3. EPOXY WICKING FROM THE REAR OF THE INSULATOR ON INSULATED LEADS MUST NOT EXCEED .125 MAX ON #25 AWG AND SMALLER LEADS AND .200 MAX ON #24 AWG AND LARGER LEADS
 - 4. CRIMP LEADS INTO CONTACTS PER MEP 302-05

Tyco Dwg 8-1532148-5
Micro P/N 095-0000-0326

QTY REQD	CODE IDENT	PART OR IDENTIFYING NO.	NOMENCLATURE OR DESCRIPTION
PARTS LIST			
UNLESS OTHERWISE SPECIFIED DIMENSIONS ARE IN INCHES TOLERANCES ARE: FRACTIONS DECIMALS ANGLES ± 1/64 .XX ± .01 ± 0°-30' .XXX ± .005		CONTRACT NO.	
MATERIAL		APPROVALS	DATE
FINISH		CHECKED	
NEXT ASSY		PR. ENG.	
USED ON		ARPD.	
APPLICATION		MALCO A MICRODOT COMPANY, INC. 220 PASADENA AVE., SO. PASADENA, CALIF. 91030 RACK AND PANEL CONN. MCDG 3-9 S SCREW MOUNTING PROD. CODE 824 CODE M	
DO NOT SCALE DRAWING		SIZE	CODE IDENT NO. DRAWING NO.
		B	98278 095-0000-0326
		SCALE NONE	SHEET 1 of 1