

SLIN-12F2A

Non-Isolated DC-DC Converter

The SLIN-12F2A series of power modules are non-isolated dc/dc converters that can deliver up to 12 A of output current. These modules operate over a wide range of input voltage ($V_{IN} = 2.4 - 5.5$ VDC) and provide a precisely regulated output voltage from 0.6 VDC to 3.63 VDC, programmable via an external resistor.

Features include remote on/off, adjustable output voltage, over current protection, and over temperature protection. A new feature, the Tunable Loop™, allows the user to optimize the dynamic response of the converter to match the load with reduced amount of output capacitance leading to savings on cost and PWB area.



Key Features & Benefits

- Wide Input Voltage Range
- Output Voltage Programmable
- Over Temperature Protection
- Fixed Switching Frequency
- Remote On/Off
- Remote Sense
- Output Over Current Protection
- Ability to Sink and Source Current
- Cost Efficient Open Frame Design
- Tunable Loop™ to Optimize Dynamic Output Voltage Response
- Class II, Category 2, Non-Isolated DC/DC Converter (refer to IPC-9592B)
- Certificated to UL/CSA 62368-1

Applications

- Distributed Power Architectures
- Servers and Storage Applications
- Intermediate Bus Voltage Applications
- Networking Equipment
- Telecommunications Equipment
- Industrial Equipment

1. MODEL SELECTION

MODEL NUMBER ACTIVE LOW	MODEL NUMBER ACTIVE HIGH	OUTPUT VOLTAGE	INPUT VOLTAGE	MAX. OUTPUT CURRENT	TYPICAL EFFICIENCY
SLIN-12F2ALG	SLIN-12F2A0G	0.6 - 3.63 VDC	2.4 - 5.5 VDC	12 A	92.7%
SLIN-12F2ALR	SLIN-12F2A0R				

PART NUMBER EXPLANATION

S	LIN	-	12	F	2A	x	y
Mounting Type	Series Code		Output Current	Input Voltage Range	Sequencing or not	Active Logic	Package
Surface Mount	SLIN Series		12 A	2.4 - 5.5 V	Without Sequencing	0 - Active High L - Active Low	G – Tray Package R – Tape and Reel Package

2. ABSOLUTE MAXIMUM RATINGS

PARAMETER	DESCRIPTION	MIN	TYP	MAX	UNITS
Continuous Input Voltage		-0.3	-	6	V
Operating Ambient Temperature		-40	-	85	°C
Storage Temperature		-55	-	125	°C
Altitude		-	-	2000	m

NOTE: Stresses in excess of the absolute maximum ratings can cause permanent damage to the device. These are absolute stress ratings only, functional operation of the device is not implied at these or any other conditions in excess of those given in the operations sections of the data sheet. Exposure to absolute maximum ratings for extended periods can adversely affect the device reliability.

3. INPUT SPECIFICATIONS

PARAMETER	DESCRIPTION	MIN	TYP	MAX	UNIT
Operating Input Voltage		2.4	-	5.5	V
Input Current (full load)	VIN = 2.4 V to 5.5 V, Io = Io, max	-	-	11	A
Input Current (no load)	VIN = 5.0 V, Vo = 0.6 V, Io = 0, module enabled	-	36	-	mA
	VIN = 5.0 V, Vo = 3.3 V, Io = 0, module enabled	-	81	-	mA
Input Stand-by Current	VIN = 5 V, module disabled	-	3	-	mA
Input Reflected Ripple Current (pk-pk)	5 Hz to 20 MHz, 1 μ H source impedance; VIN = 0 to 5.5 V, Io = Io, max	-	49	-	mA
I ² t Inrush Current Transient		-	-	1	A ² s
Input Ripple Rejection (120 Hz)		-	-30	-	dB
Turn-on Threshold		-	-	2.2	V
Turn-off Threshold		1.75	-	-	V
Hysteresis		0.08	-	0.2	V

CAUTION: This converter is not internally fused. An input line fuse must be used in application.

This power module can be used in a wide variety of applications, ranging from simple standalone operation to an integrated part of sophisticated power architecture. To preserve maximum flexibility, internal fusing is not included; however, to achieve maximum safety and system protection, always use an input line fuse. The safety agencies require a fast-acting fuse with a maximum rating of 15A. Based on the information provided in this data sheet on inrush energy and maximum dc input current, the same type of fuse with a lower rating can be used. Refer to the fuse manufacturer's data sheet for further information.

NOTE: Unless otherwise indicated, specifications apply over entire operating input voltage range, resistive load, and temperature conditions.

4. OUTPUT SPECIFICATIONS

PARAMETER	DESCRIPTION	MIN	TYP	MAX	UNIT
Output Voltage Set Point	With 0.5% tolerance for external resistor used to set output voltage	-1.5	-	+1.5	%Vo,set
Output Voltage	Over entire operating input voltage range, resistive load, and temperature conditions until end of life	-3.0	-	+3.0	%Vo,set
Adjustment Range	Selected by an external resistor	0.6	-	3.63	V
Remote Sense Range		-	-	0.5	V
Output Regulation (for Vo ≥ 2.5 VDC)	Line Regulation, VIN = VIN, min to VIN, max	-	-	0.4	%Vo,set
	Load Regulation, Io = Io, min to Io, max	-	-	10	mV
Output Regulation (for Vo < 2.5 VDC)	Line Regulation, VIN = VIN, min to VIN, max	-	-	10	mV
	Load Regulation, Io = Io, min to Io, max	-	-	5	mV
	Temperature Regulation, Tref = TA, min to TA, max	-	-	0.4	%Vo,set
Output Current Range		0	-	12	A
Output DC Current Limit	Hiccup Mode	-	-	200	%Io,max
Output Ripple and Noise (pk-pk)	5 Hz to 20 MHz BW, VIN = VIN, nom and Io = Io, min to Io, max, Co = 0.1 μF // 10 μF ceramic capacitors	-	25	35	mV
Output Ripple and Noise (rms)		-	10	15	mV
Output Short-Circuit Current	Vo ≤ 250 mV, Hiccup Mode	-	30	-	%Io,max
Turn-On Delay Time	Case 1: On/Off input is enabled and then input power is applied (delay from instant at which VIN = VIN, min until Vo = 10% of Vo, set)	-	2	-	ms
	Case 2: Input power is applied for at least one second and then the On/Off input is enabled (delay from instant at which Von/Off is enabled until Vo = 10% of Vo, set)	-	2	-	ms
Output Voltage Overshoot	Vin = Vin, min to Vin, max, Io = Io, max, With or without maximum external capacitance	-	-	3	%Vo
Output Voltage Rise Time	Time for Vo to rise from 10% of Vo, set to 90% of Vo, set	-	5	-	ms
Output Capacitance	ESR ≥ 1 mΩ Without the Tunable Loop™	0	-	200	
	ESR ≥ 0.15 mΩ With the Tunable Loop™	0	-	1000	μF
	ESR ≥ 10 mΩ With the Tunable Loop™	0	-	5000	

NOTE: Unless otherwise indicated, specifications apply over entire operating input voltage range, resistive load, and temperature conditions.

5. GENERAL SPECIFICATIONS

PARAMETER	DESCRIPTION	MIN	TYP	MAX	UNIT
Efficiency	Vo = 0.6 V	-	75.0	-	
	Vo = 1.2 V	-	85.5	-	
	Vo = 1.8 V	-	89.9	-	%
	Vo = 2.5 V	-	92.7	-	
	Vo = 3.3 V	-	94.6	-	
Switching Frequency		-	600	-	kHz
Over Temperature Protection		-	130	-	°C
Weight		-	3.59	-	g
MTBF	Calculated MTBF (Vin = 5 V, Io = full load, Ta = 25°C) Telcordia Issue 2, Method 1 Case 3		28,160,677		hours
Dimensions (L × W × H)			0.80 × 0.45 × 0.334		inch
			20.32 × 11.43 × 8.50		mm

NOTE: Unless otherwise indicated, specifications apply over entire operating input voltage range, resistive load, and temperature condition.



Asia-Pacific
+86 755 298 85888

Europe, Middle East
+353 61 49 8941

North America
+1 866 513 2839

6. EFFICIENCY DATA

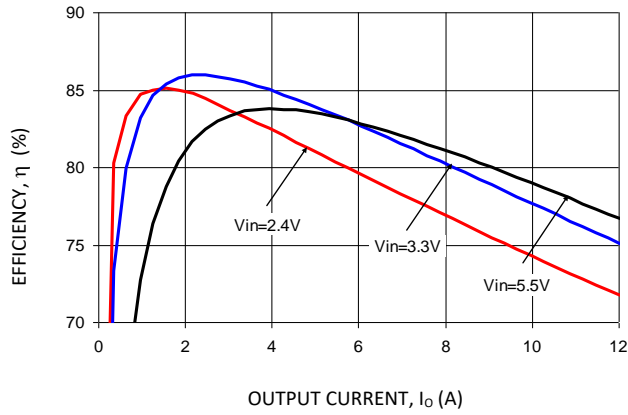

Figure 1. Vo = 0.6 V

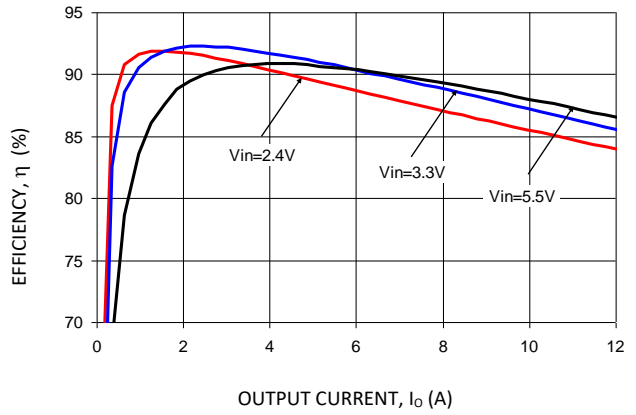

Figure 2. Vo = 1.2 V

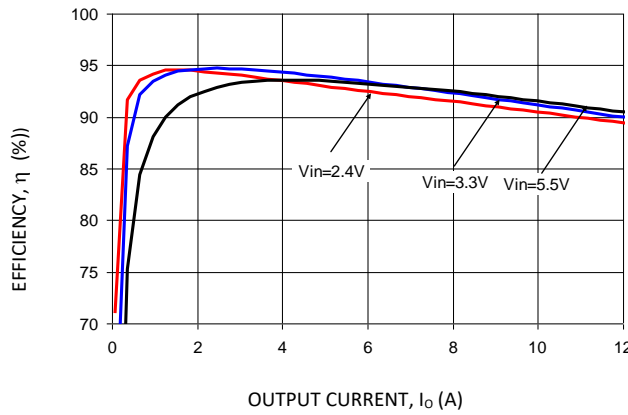

Figure 3. Vo = 1.8 V

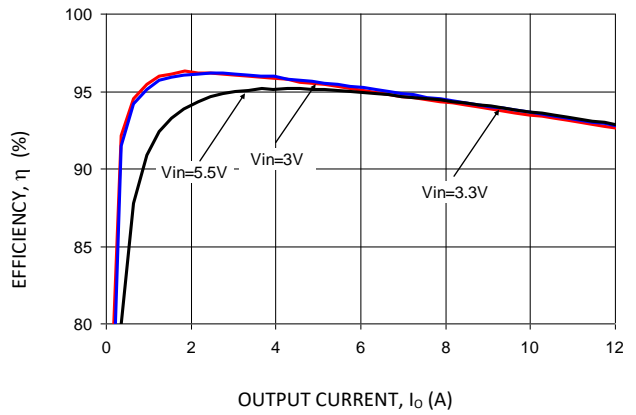

Figure 4. Vo = 2.5 V

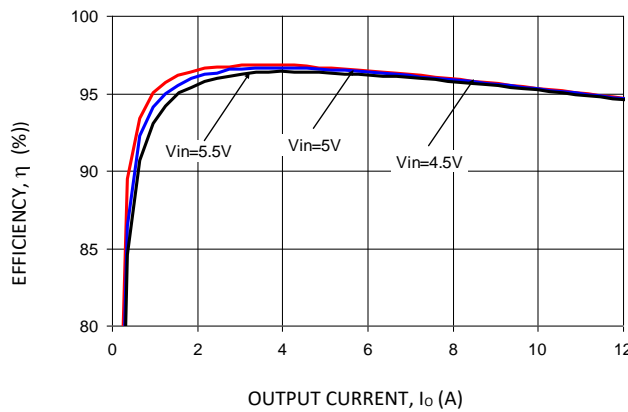

Figure 5. Vo = 3.3 V

7. THERMAL DERATING CURVES

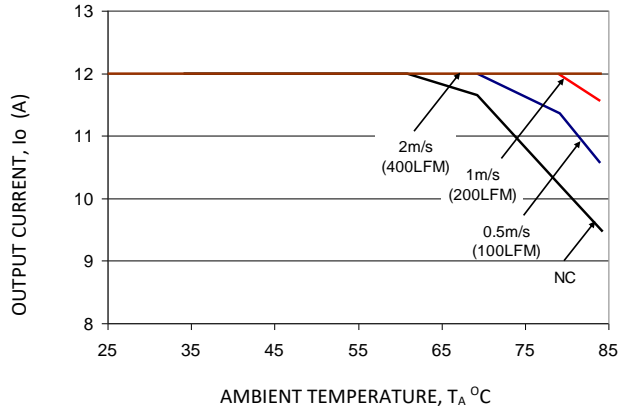

Figure 6. $V_o = 0.6 V$

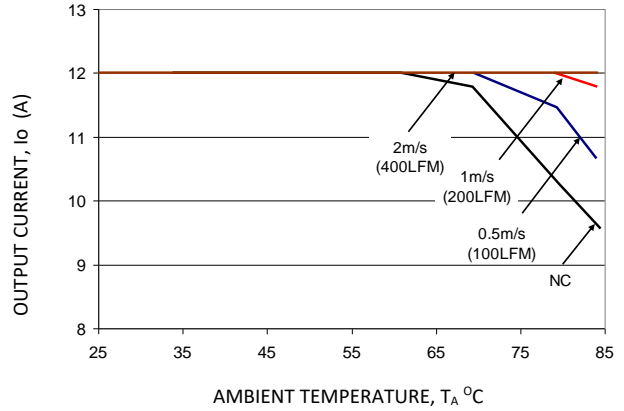

Figure 7. $V_o = 1.2 V$

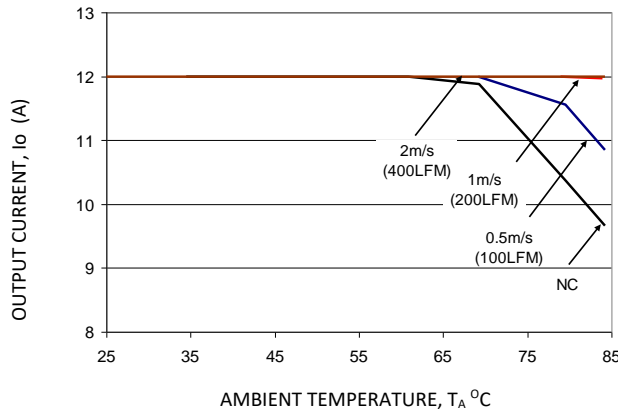

Figure 8. $V_o = 1.8 V$

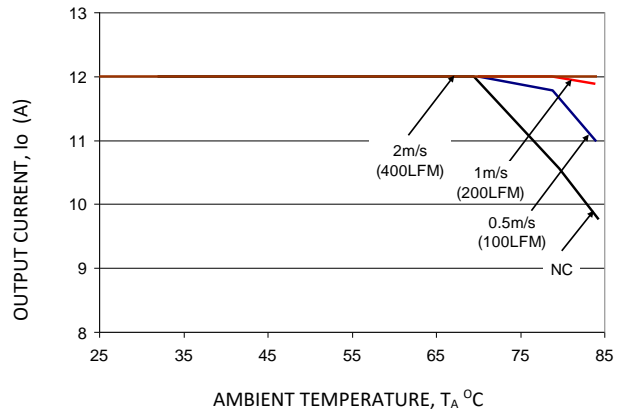

Figure 9. $V_o = 2.5 V$

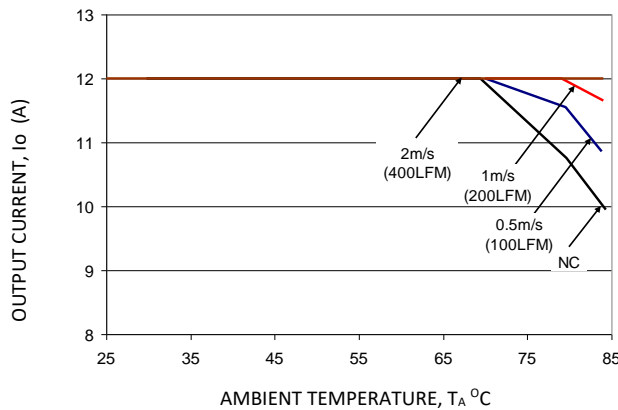

Figure 10. $V_o = 3.3 V$



Asia-Pacific
+86 755 298 85888

Europe, Middle East
+353 61 49 8941

North America
+1 866 513 2839

8. RIPPLE AND NOISE WAVEFORMS

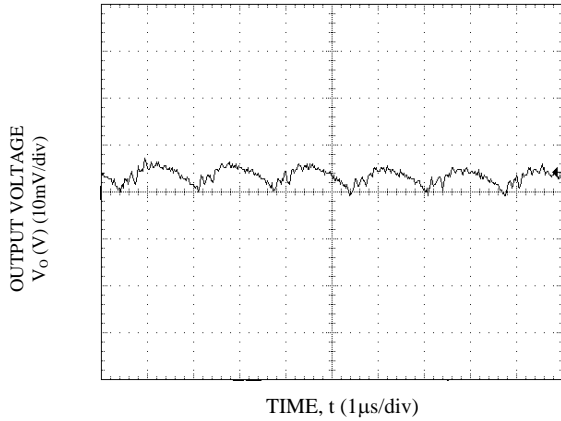

Figure 11. $V_{in} = 5\text{ V}$, $V_o = 0.6\text{ V}$, $I_o = I_{o,max}$

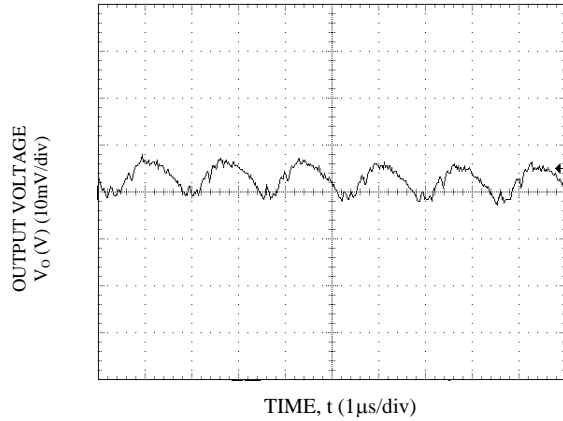

Figure 12. $V_{in} = 5\text{ V}$, $V_o = 1.2\text{ V}$, $I_o = I_{o,max}$

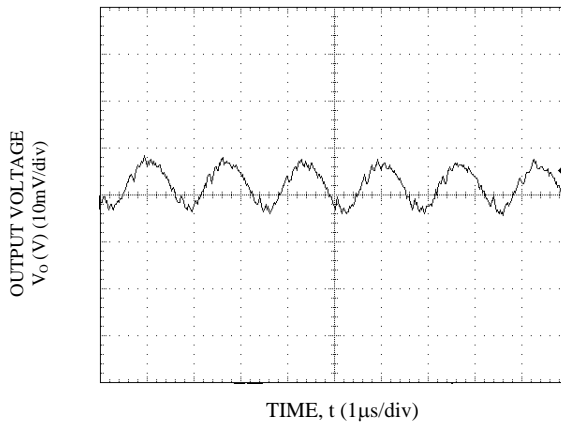

Figure 13. $V_{in} = 5\text{ V}$, $V_o = 1.8\text{ V}$, $I_o = I_{o,max}$

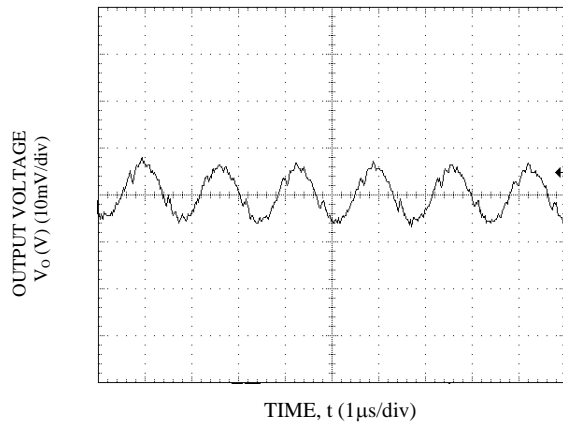

Figure 14. $V_{in} = 5\text{ V}$, $V_o = 2.5\text{ V}$, $I_o = I_{o,max}$

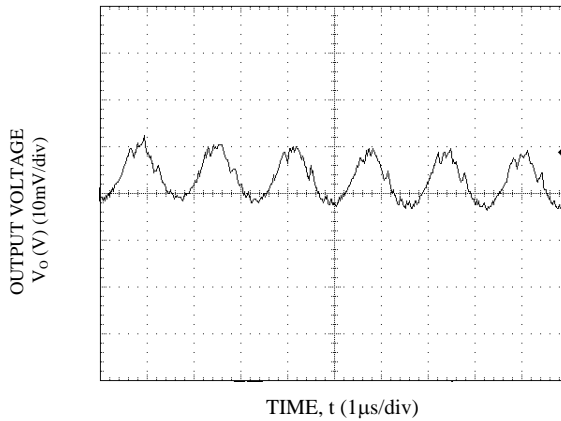

Figure 15. $V_{in} = 5\text{ V}$, $V_o = 3.3\text{ V}$, $I_o = I_{o,max}$

9. TRANSIENT RESPONSE WAVEFORMS

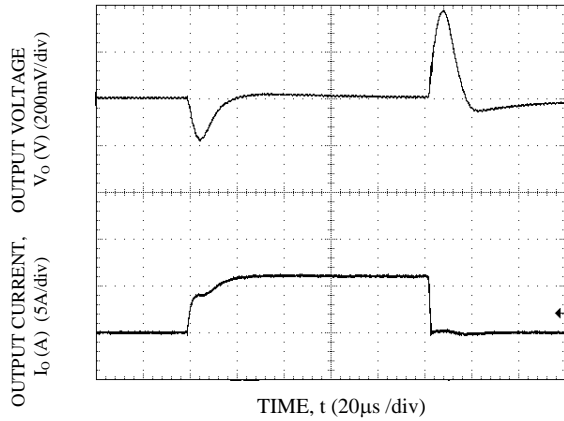

Figure 16. Transient Response to Dynamic Load Change from 0% to 50% to 0%. $V_{in} = 5\text{ V}$, $V_o = 0.6\text{ V}$

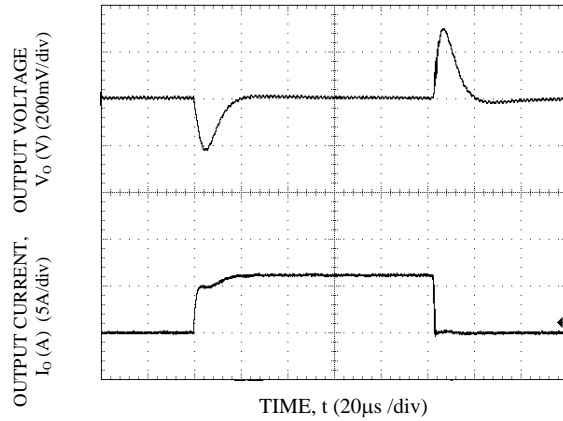

Figure 17. Transient Response to Dynamic Load Change from 0% to 50% to 0%. $V_{in} = 5\text{ V}$, $V_o = 1.2\text{ V}$

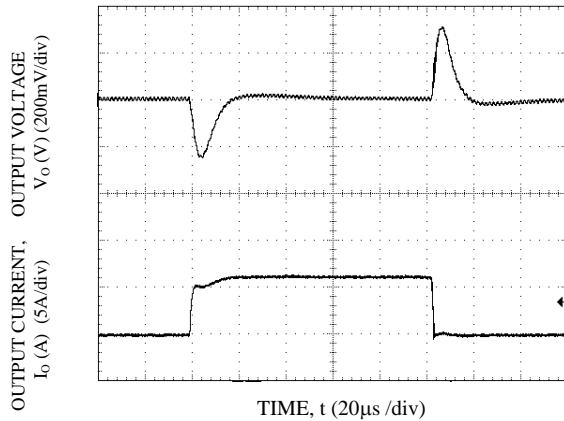

Figure 18. Transient Response to Dynamic Load Change from 0% to 50% to 0%. $V_{in} = 5\text{ V}$, $V_o = 1.8\text{ V}$

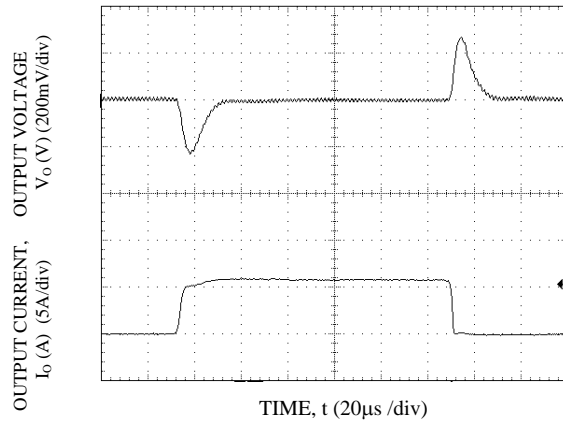

Figure 19. Transient Response to Dynamic Load Change from 0% to 50% to 0%. $V_{in} = 5\text{ V}$, $V_o = 2.5\text{ V}$

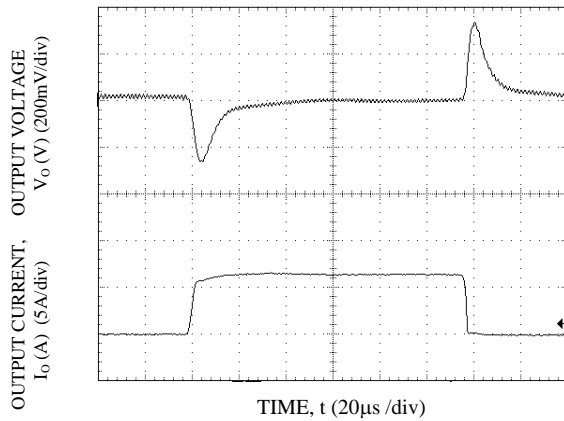

Figure 20. Transient Response to Dynamic Load Change from 0% to 50% to 0%. $V_{in} = 5\text{ V}$, $V_o = 3.3\text{ V}$

10. STARTUP TIME

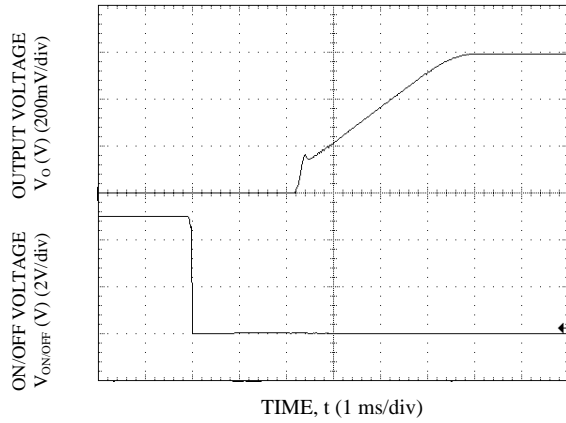

Figure 21. Start-up Using On/Off Voltage ($I_o = I_o, max$), $V_o = 0.8 V$

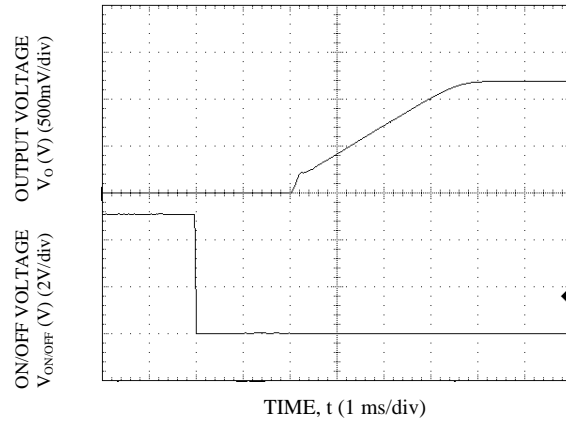

Figure 22. Start-up Using On/Off Voltage ($I_o = I_o, max$), $V_o = 1.2 V$

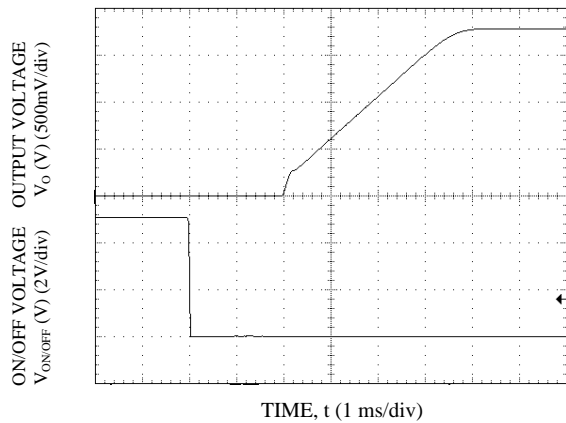

Figure 23. Start-up Using On/Off Voltage ($I_o = I_o, max$), $V_o = 1.8 V$

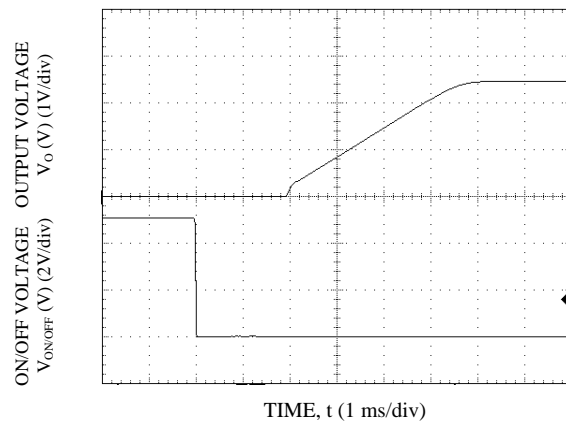

Figure 24. Start-up Using On/Off Voltage ($I_o = I_o, max$), $V_o = 2.5 V$

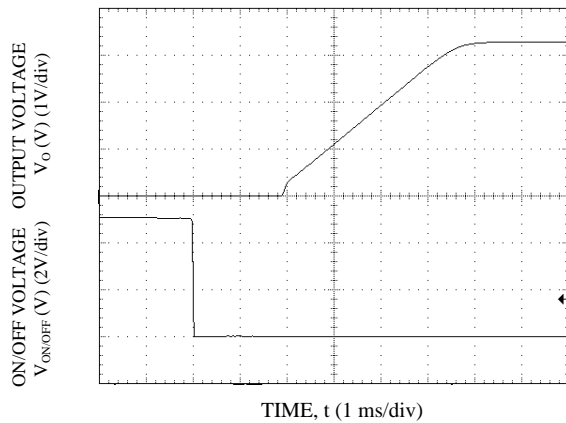

Figure 25. Start-up Using On/Off Voltage ($I_o = I_o, max$), $V_o = 3.3 V$

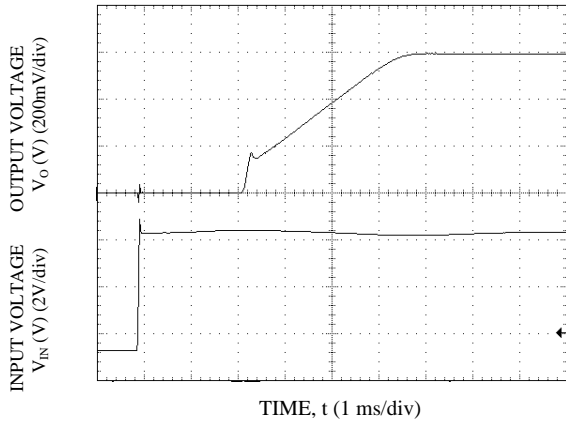

Figure 26. Start-up Using Input Voltage ($V_{IN} = 5V$, $I_o = I_{o,max}$), $V_o = 0.8 V$

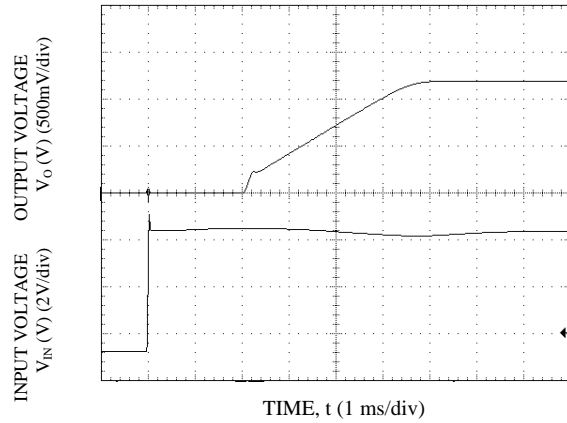

Figure 27. Start-up Using Input Voltage ($V_{IN} = 5V$, $I_o = I_{o,max}$), $V_o = 1.2 V$

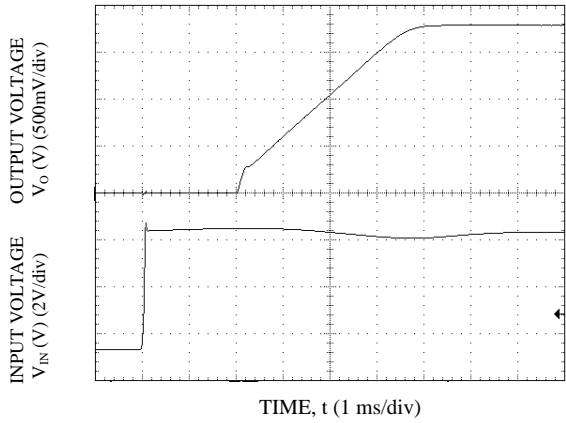

Figure 28. Start-up Using Input Voltage ($V_{IN} = 5V$, $I_o = I_{o,max}$), $V_o = 1.8 V$

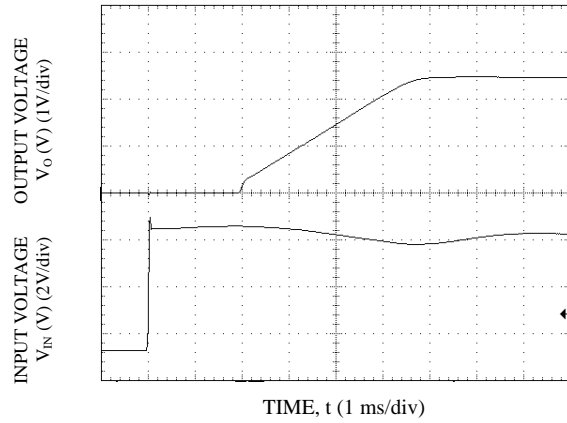

Figure 29. Start-up Using Input Voltage ($V_{IN} = 5V$, $I_o = I_{o,max}$), $V_o = 2.5 V$

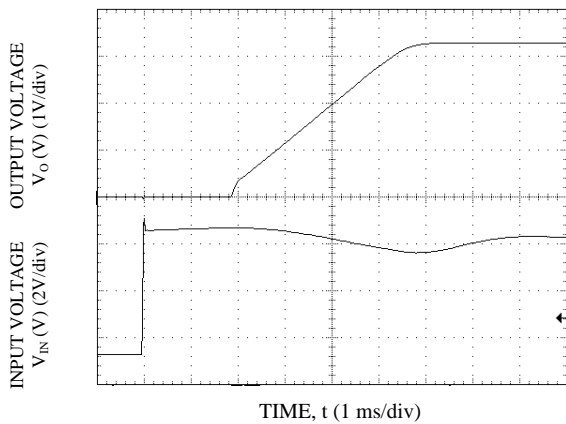
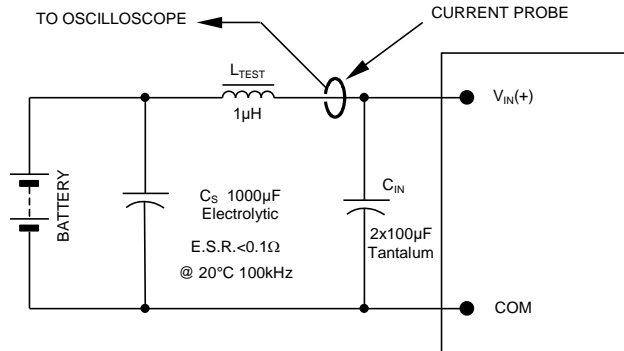

Figure 30. Start-up Using Input Voltage ($V_{IN} = 5V$, $I_o = I_{o,max}$), $V_o = 3.3 V$

11. TEST CONFIGURATIONS

Input Reflected Ripple Current Test Setup.



NOTE: Measure input reflected ripple current with a simulated source inductance (L_{TEST}) of $1\mu H$. Capacitor C_S offsets possible battery impedance. Measure current as shown above.

Figure 31.

Output Ripple and Noise Test Setup.

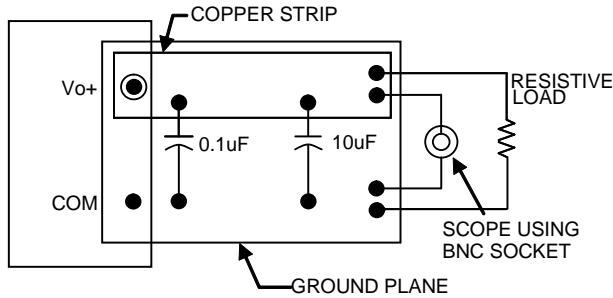

NOTE: All voltage measurements to be taken at the module terminals, as shown above. If sockets are used then Kelvin connections are required at the module terminals to avoid measurement errors due to socket contact resistance.

Figure 32.

Output Voltage and Efficiency Test Setup.

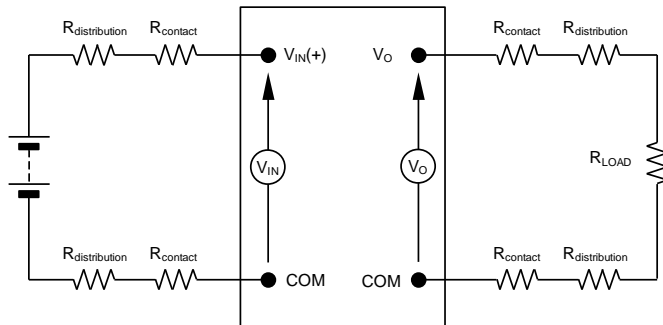

NOTE: All voltage measurements to be taken at the module terminals, as shown above. If sockets are used then Kelvin connections are required at the module terminals to avoid measurement errors due to socket contact resistance.

$$\text{Efficiency } \eta = \frac{V_O \cdot I_O}{V_{IN} \cdot I_{IN}} \times 100 \%$$

Figure 33.

12. INPUT FILTERING

The SLIN-12F2Ax module should be connected to a low ac-impedance source. A highly inductive source can affect the stability of the module. An input capacitor must be placed directly adjacent to the input pin of the module, to minimize input ripple voltage and ensure module stability.

To minimize input voltage ripple, low-ESR ceramic capacitors are recommended at the input of the module. Figure 34 shows the input ripple voltage for various output voltages at 3 A of load current with 1x47 μF or 2x47 μF ceramic capacitors and an input of 5 V. Figure 35 shows data for the 3.3 V_{in} case, with 1x47 μF or 2x47 μF of ceramic capacitors at the input.

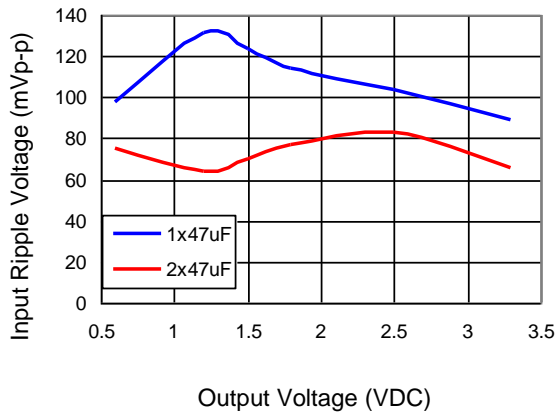

Figure 34.

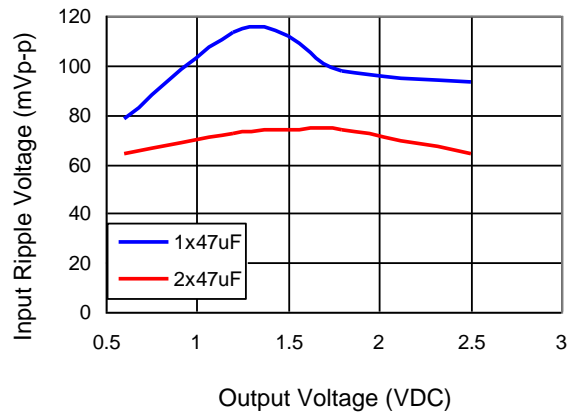

Figure 35.

13. OUTPUT FILTERING

The SLIN-12F2Ax modules are designed for low output ripple voltage and will meet the maximum output ripple specification with 0.1 μF ceramic and 10 μF ceramic capacitors at the output of the module. However, additional output filtering may be required by the system designer for several reasons. First, there may be a need to further reduce the output ripple and noise of the module. Second, the dynamic response characteristics may need to be customized to a particular load step change.

To reduce the output ripple and improve the dynamic response to a step load change, additional capacitance at the output can be used. Low ESR ceramic and polymer capacitors are recommended to improve the dynamic response of the module. Figure 36 below provides output ripple information for different external capacitance values at various V_o and for load currents of 12 A while maintaining an input voltage of 5 V. Figure 37 below shows the performance with a 3.3 V input. For stable operation of the module, limit the capacitance to less than the maximum output capacitance as specified in the electrical specification table. Optimal performance of the module can be achieved by using the Tunable Loop™ feature described later in this data sheet.

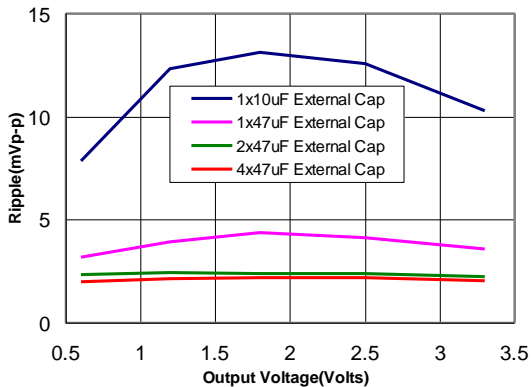

Figure 36.

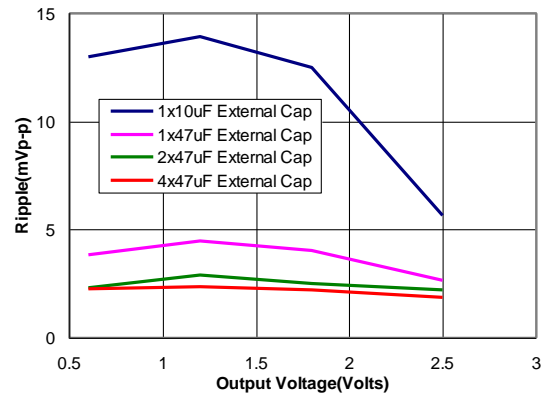

Figure 37.

14. SAFETY CONSIDERATIONS

For safety agency approval the power module must be installed in compliance with the spacing and separation requirements of the end-use safety agency standards, i.e., UL/CSA 62368-1 Licensed.

For the converter output to be considered meeting the requirements of electrical energy source class 1 (ES1), the input must meet ES1 requirements.

15. FEATURE DESCRIPTIONS

REMOTE ON/OFF

PARAMETER		DESCRIPTION	MIN	TYP	MAX	UNIT
Signal Low (Unit On)	Active Low	The remote on/off pin open, Unit on.	-0.2	-	$V_{in}-1.6$	V
Signal High (Unit Off)			$V_{in}-0.8$	-	$V_{in,max}$	
Signal Low (Unit Off)	Active High	The remote on/off pin open, Unit on.	-0.2	-	0.3	V
Signal High (Unit On)			$V_{in}-0.8$	-	$V_{in,max}$	

The SLIN-12F2Ax modules feature an On/Off pin for remote On/Off operation. Two On/Off logic options are available. In the Positive Logic On/Off option, the module turns ON during a logic High on the On/Off pin and turns OFF during a logic Low. With the Negative Logic On/Off option, the module turns OFF during logic High and ON during logic Low. The On/Off signal is always referenced to ground. For either On/Off logic option, leaving the On/Off pin disconnected will turn the module ON when input voltage is present.

For positive logic modules, the circuit configuration for using the On/Off pin is shown in Figure 38 below. When the external transistor Q1 is in the OFF state, Q2 is ON, the internal PWM Enable signal is pulled low and the module is ON. When transistor Q1 is turned ON, the On/Off pin is pulled low, Q2 is turned off and the internal PWM Enable signal is pulled high through the 23.7K pull-up resistor and the module is OFF.

For negative logic On/Off modules, the circuit configuration is shown in Figure 39 below. The On/Off pin should be pulled high with an external pull-up resistor (suggested value for the 2.4V to 5.5V_{in} range is 3Kohms). When transistor Q1 is in the OFF state, the On/Off pin is pulled high and the module is OFF. The On/Off threshold for logic High on the On/Off pin depends on the input voltage and its minimum value is $V_{IN} - 1.6V$. To turn the module ON, Q1 is turned ON pulling the On/Off pin low.

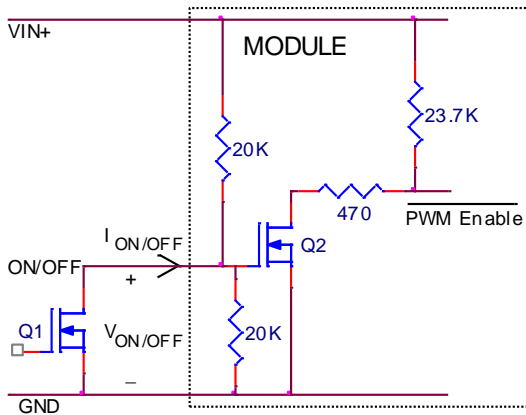

Figure 38.

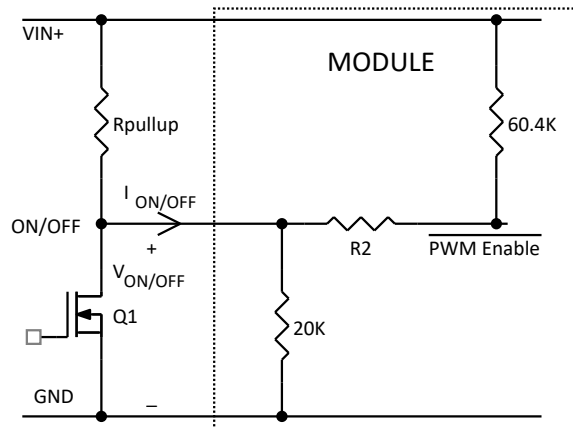

Figure 39.

16. OVER CURRENT PROTECTION

To provide protection in a fault (output overload) condition, the unit is equipped with internal current limiting circuitry and can endure current limiting continuously. At the point of current limit inception, the unit enters hiccup mode. The unit operates normally once the output current is brought back into its specified range.



Asia-Pacific
+86 755 298 85888

Europe, Middle East
+353 61 49 8941

North America
+1 866 513 2839

17. OVER TEMPERATURE PROTECTION

To provide protection in a fault condition, the unit is equipped with a thermal shutdown circuit. The unit will shut down if the over temperature threshold of 130°C is exceeded at the thermal reference point Tref. The thermal shutdown is not intended as a guarantee that the unit will survive temperatures beyond its rating. Once the unit goes into thermal shutdown it will then wait to cool before attempting to restart.

18. INPUT UNDER-VOLTAGE LOCKOUT

At input voltages below the input under voltage lockout limit, the module operation is disabled. The module will begin to operate at an input voltage above the under-voltage lockout turn-on threshold.

19. OUTPUT VOLTAGE PROGRAMMING

The output voltage of the SLIN-12F2Ax module can be programmed to any voltage from 0.6dc to 3.63 VDC by connecting a resistor between the Trim and GND pins of the module. Certain restrictions apply on the output voltage set point depending on the input voltage. These are shown in the Output Voltage vs. Input Voltage Set Point Area plot in the figure below. The Upper Limit curve shows that the entire output voltage range is available with the maximum input voltage of 5.5 V. The Lower Limit curve shows that for output voltages of 1.8 V and higher, the input voltage needs to be larger than the minimum of 2.4 V.

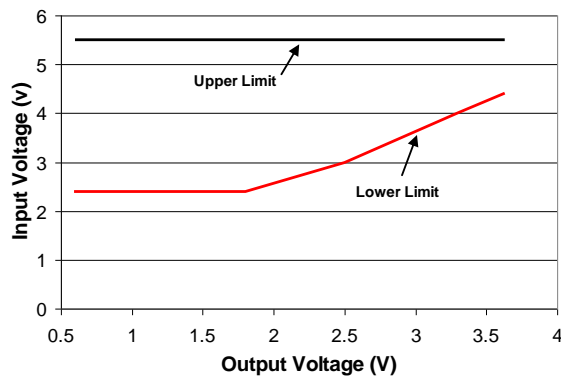

Figure 40.

Without an external resistor between Trim and GND pins, the output of the module will be 0.6 VDC. To calculate the value of the trim resistor, Rtrim for a desired output voltage, use the following equation:

$$R_{trim} = \left[\frac{1.2}{(V_o - 0.6)} \right] k\Omega$$

Rtrim is the external resistor in kΩ

Vo is the desired output voltage

By using a ±0.5% tolerance trim resistor with a TC of ±25 ppm, a set point tolerance of ±1.5% can be achieved as specified in the electrical specification. Table 1 provides Rtrim values required for some common output voltages.

VO, set (V)	RTRIM (KΩ)
0.6	Open
1.0	3.0
1.2	2.0
1.5	1.333
1.8	1.0
2.5	0.632
3.3	0.444

Table 1.

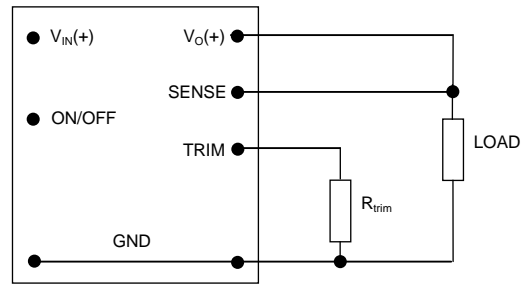

Figure 41. Circuit configuration for programming output voltage using an external resistor

20. REMOTE SENSE

The SLIN-12F2Ax power modules have a Remote Sense feature to minimize the effects of distribution losses by regulating the voltage at the SENSE pin. The voltage between the SENSE pin and VOUT pin must not exceed 0.5 V. Note that the output voltage of the module cannot exceed the specified maximum value. This includes the voltage drop between the SENSE and Vout pins. When the Remote Sense feature is not being used, connect the SENSE pin to the VOUT pin.

21. VOLTAGE MARGINING

Output voltage margining can be implemented in the SLIN-12F2Ax modules by connecting a resistor, Rmargin-up, from the Trim pin to the ground pin for margining-up the output voltage and by connecting a resistor, Rmargin-down, from the Trim pin to output pin for margining-down. The figure below shows the circuit configuration for output voltage margining.

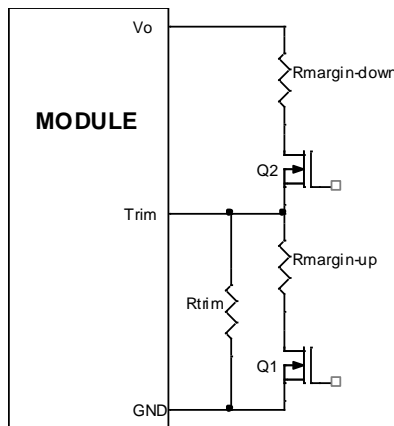

Figure 42. Circuit Configuration for margining Output voltage

22. MONOTONIC START-UP AND SHUTDOWN

The SLIN-12F2Ax modules have monotonic start-up and shutdown behavior for any combination of rated input voltage, output current and operating temperature range.

23. STARTUP INTO PRE-BIASED OUTPUT

The SLIN-12F2Ax modules can start into a pre-biased output as long as the pre-bias voltage is 0.5 V less than the set output voltage.

24. TUNABLE LOOP™

The SLIN-12F2Ax modules have a new feature that optimizes transient response of the module called Tunable Loop™.

External capacitors are usually added to the output of the module for two reasons: to reduce output ripple and noise and to reduce output voltage deviations from the steady-state value in the presence of dynamic load current changes. Adding external capacitance however affects the voltage control loop of the module, typically causing the loop to slow down with sluggish response. Larger values of external capacitance could also cause the module to become unstable.

The Tunable Loop™ allows the user to externally adjust the voltage control loop to match the filter network connected to the output of the module. The Tunable Loop™ is implemented by connecting a series R-C between the SENSE and TRIM pins of the module. This R-C allows the user to externally adjust the voltage loop feedback compensation of the module.

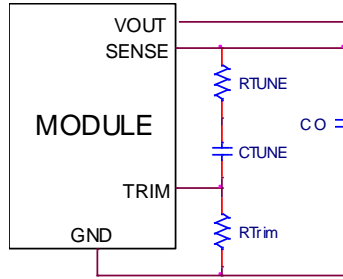

Figure 43. Circuit diagram showing connection of R_{TUNE} and C_{TUNE} to tune the control loop of the module.

Recommended values of R_{TUNE} and C_{TUNE} for different output capacitor combinations are given in Tables 2, 3, 4 and 5. Tables 2 and 4 show the recommended values of R_{TUNE} and C_{TUNE} for different values of ceramic output capacitors up to 940 μF that might be needed for an application to meet output ripple and noise requirements for 5Vin and 3.3Vin respectively. Selecting R_{TUNE} and C_{TUNE} according to Table 2 will ensure stable operation of the module.

In applications with tight output voltage limits in the presence of dynamic current loading, additional output capacitance will be required. Tables 3 and 5 list recommended values of R_{TUNE} and C_{TUNE} in order to meet 2% output voltage deviation limits for some common output voltages in the presence of a 6 A to 12 A step change (50% of full load), with an input voltage of 5 Vin and 3.3 Vin respectively.

Table 2. General recommended values of R_{TUNE} and C_{TUNE} for $V_{in} = 5\text{ V}$ and various external ceramic capacitor combinations.

C_o	1x47 μF	2x47 μF	4x47 μF	10x47 μF	20x47 μF
R_{TUNE}	47 Ω	47 Ω	47 Ω	33 Ω	22 Ω
C_{TUNE}	1500 pF	3900 pF	10 nF	33 nF	56 nF

Table 2.

Table 3. Recommended values of R_{TUNE} and C_{TUNE} to obtain transient deviation of 2% of V_{out} for a 6 A step load with $V_{in} = 5\text{ V}$.

V_o	3.3 V	2.5 V	1.8 V	1.2 V	0.6 V
C_o	330 μF Polymer Cap	1x47 μF + 330 μF Polymer Cap	4x47 μF + 330 μF Polymer Cap	4x47 μF + 2x330 μF Polymer Cap	6x330 μF Polymer Cap
R_{TUNE}	56 Ω	33 Ω	33 Ω	33 Ω	33 Ω
C_{TUNE}	15 nF	18 nF	27 nF	47 nF	220 nF
ΔV	66 mV	49 mV	35 mV	24 mV	12 mV

Table 3.

Table 4. General recommended values of R_{TUNE} and C_{TUNE} for $V_{in} = 3.3\text{ V}$ and various external ceramic capacitor combinations.

C_{ext}	1x47 μF	2x47 μF	4x47 μF	10x47 μF	20x47 μF
R_{TUNE}	47 Ω	47 Ω	33 Ω	33 Ω	22 Ω
C_{TUNE}	3300 pF	6800 pF	15 nF	47 nF	68 nF

Table 4.

Table 5. Recommended values of R_{TUNE} and C_{TUNE} to obtain transient deviation of 2% of V_{out} for a 6 A step load with $V_{in} = 3.3\text{ V}$.

V_o	2.5 V	1.8 V	1.2 V	0.6 V
C_o	2x330 μF Polymer Cap	2x330 μF Polymer Cap	3x330 μF Polymer Cap	7x330 μF Polymer Cap
R_{TUNE}	33 Ω	33 Ω	33 Ω	33 Ω
C_{TUNE}	82 nF	100 nF	180 nF	390 nF
ΔV	45 mV	32 mV	24 mV	12 mV

Table 5.

25. THERMAL CONSIDERATIONS

Power modules operate in a variety of thermal environments; however, sufficient cooling should always be provided to help ensure reliable operation.

Considerations include ambient temperature, airflow, module power dissipation, and the need for increased reliability. A reduction in the operating temperature of the module will result in an increase in reliability. The thermal data presented here is based on physical measurements taken in a wind tunnel. The test set-up is shown below.

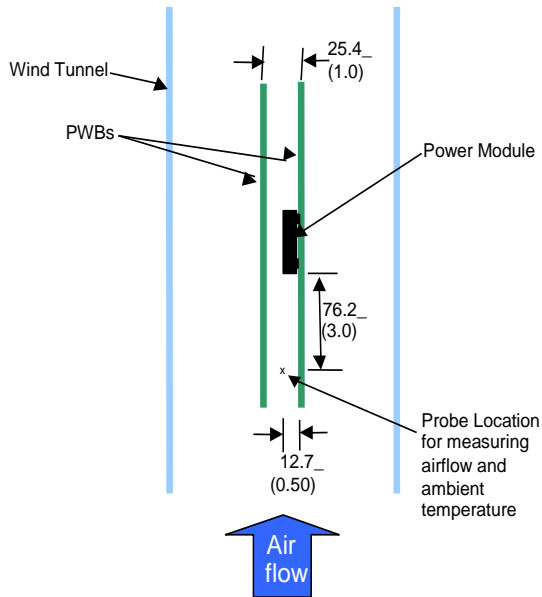

Figure 44. Thermal Test Setup

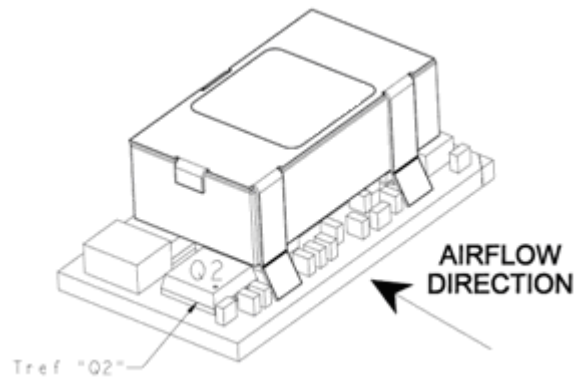

Figure 45.

The thermal reference point, T_{ref} , used in the specifications is shown below. For reliable operation the temperatures at this point should not exceed 125 °C. The output power of the module should not exceed the rated power of the module ($V_o, set \times I_o, max$).

26. EXAMPLE APPLICATION CIRCUIT

Requirements:

Vin: 3.3 V

Vout: 1.8 V

Iout: 9 A max., worst case load transient is from 6 A to 9 A

ΔV_{out} : 1.5% of Vout (27 mV) for worst case load transient

Vin, ripple 1.5% of Vin (50 mV, p-p)

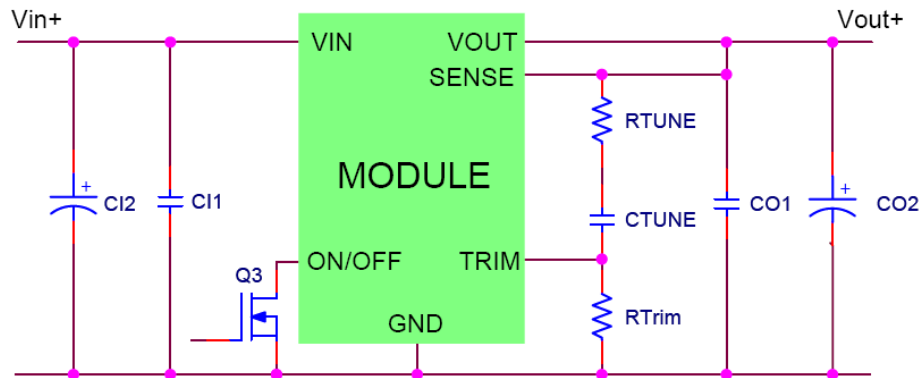

Figure 46.

C11 2 x 47 μ F/6.3 V ceramic capacitor (e.g. TDK C Series)

C12 100 μ F/6.3 V Bulk Electrolytic

CO1 6 x 47 μ F/6.3 V ceramic capacitor (e.g. TDK C Series)

CO2 330 μ F/6.3 V Polymer/poscap (e.g. Sanyo Poscap)

CTune 56 nF ceramic capacitor (can be 1206, 0805 or 0603 size)

RTune 33 Ω SMT resistor (can be 1206, 0805 or 0603 size)

RTrim 1 k Ω SMT resistor (can be 1206, 0805 or 0603 size, recommended tolerance of 0.1%)

27. MECHANICAL DIMENSIONS
OUTLINE

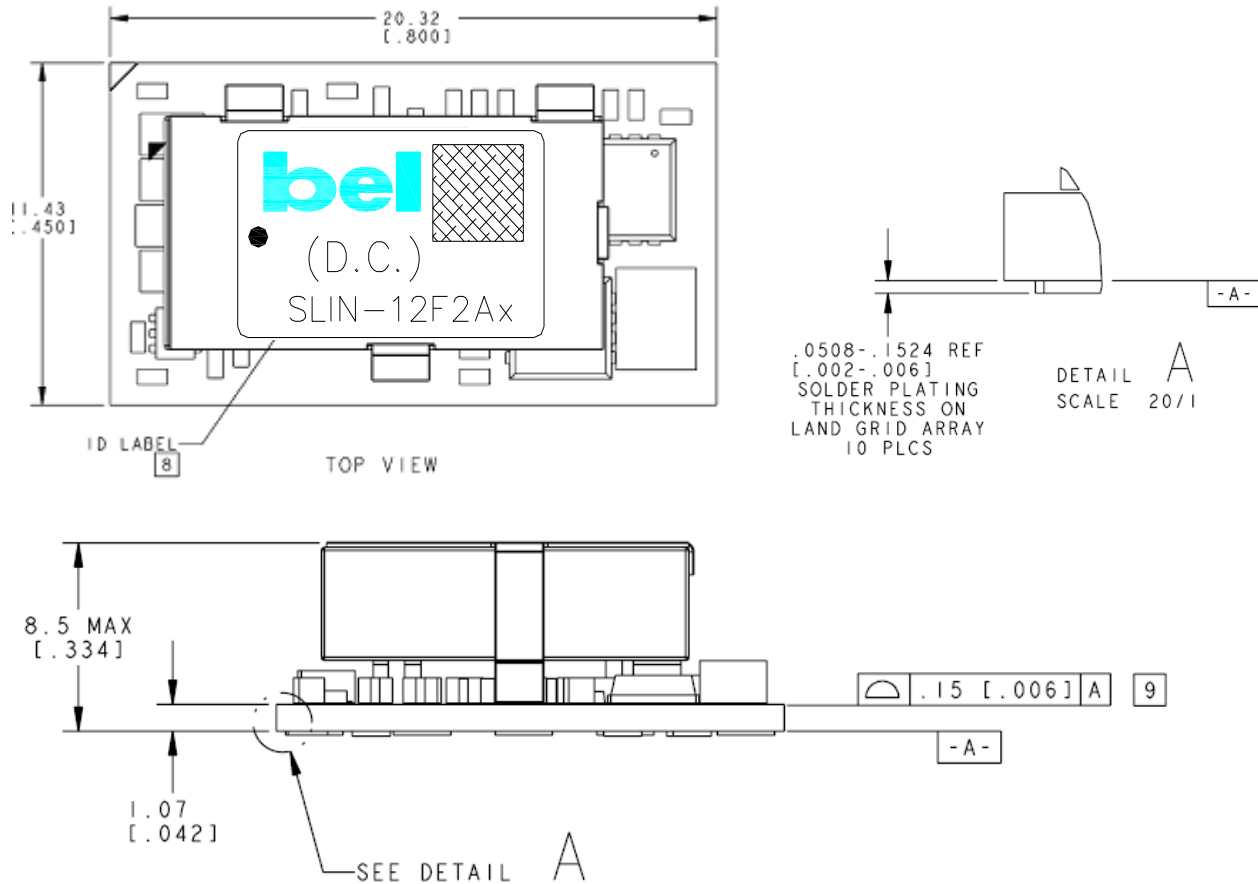

Figure 47. Outline

Notes:

Dimensions are in millimeter [inch].

Tolerances: x.x ± 0.5 mm [0.02 inch] [unless otherwise indicated]

x.xx ± 0.25 mm [0.010 inch]

RECOMMENDED PAD LAYOUT

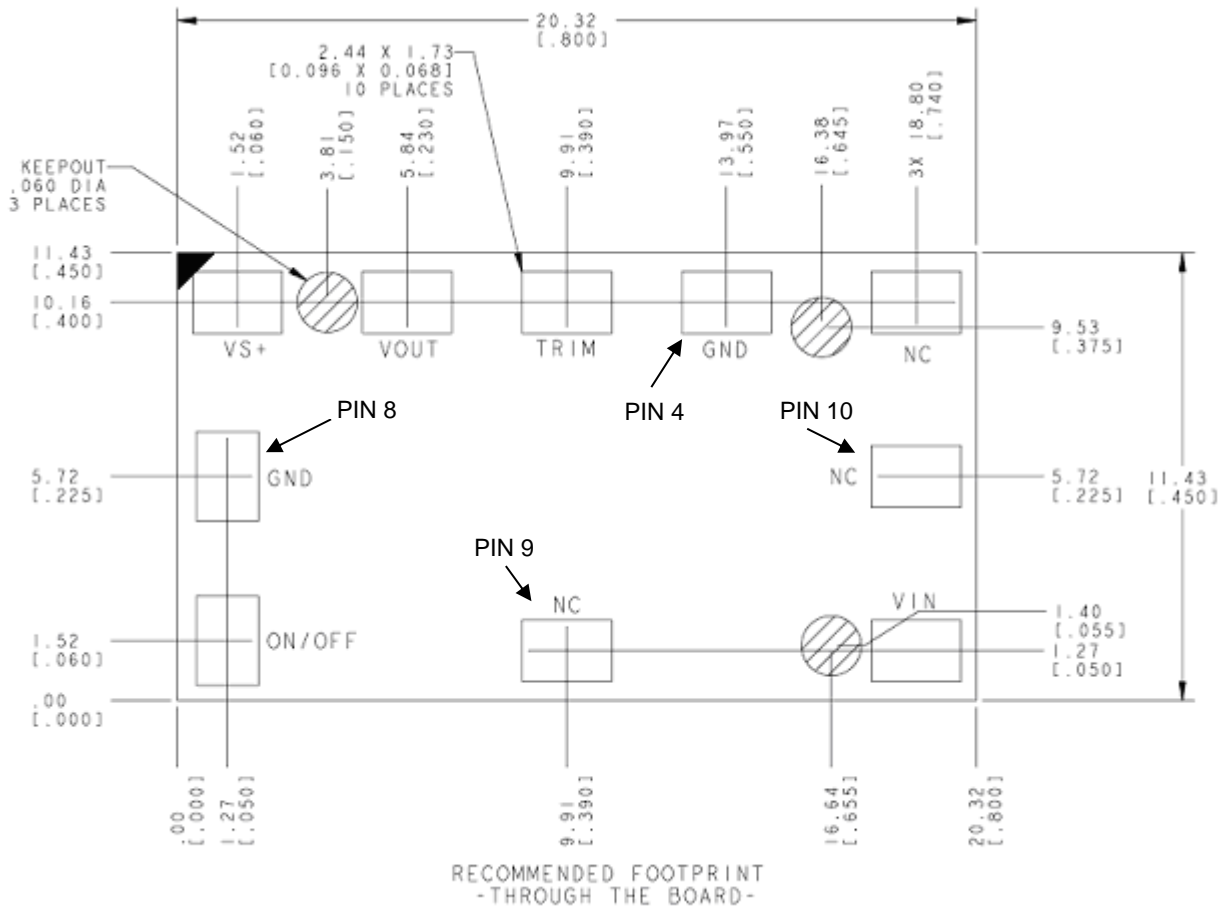

Figure 48. Recommended pad layout

PIN	FUNCTION	PIN	FUNCTION
1	ON/OFF	6	VOUT
2	VIN	7	VS+
3	NC	8	GND
4	GND	9	NC
5	TRIM	10	NC

28. PACKAGING DETAILS

The SLIN-12F2Ax modules are supplied in tape & reel as standard.
All Dimensions are in millimeter [inch].

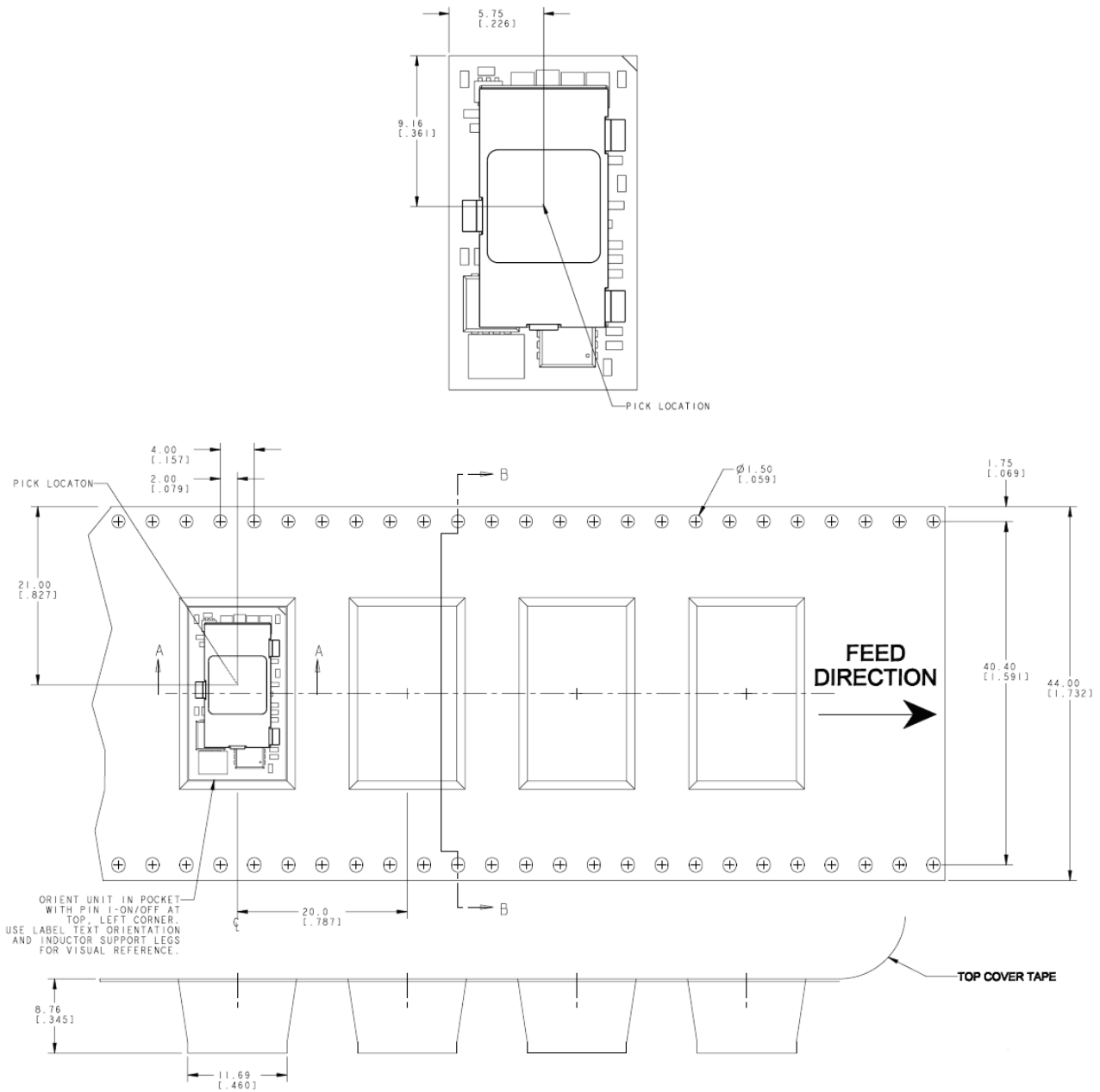

Figure 49.

Reel Dimensions:
 Outside Dimensions: 330.2 mm [13.00 inch]
 Inside Dimensions: 177.8 mm [7.00 inch]
 Tape Width: 44.00 mm [1.73 inch]



Asia-Pacific +86 755 298 85888	Europe, Middle East +353 61 49 8941	North America +1 866 513 2839
-----------------------------------	--	----------------------------------

29. SURFACE MOUNT INFORMATION

PICK AND PLACE

The SLIN-12F2Ax modules use an open frame construction and are designed for a fully automated assembly process. The modules are fitted with a label designed to provide a large surface area for pick and place operations. The label meets all the requirements for surface mount processing, as well as safety standards, and is able to withstand reflow temperatures of up to 300°C. The label carries product information such as part number and serial number.

NOZZLE RECOMMENDATIONS

The module weight has been kept to a minimum by using open frame construction. Variables such as nozzle size, tip style, vacuum pressure and placement speed should be considered to optimize this process. The minimum recommended inside nozzle diameter for reliable operation is 3mm. The maximum nozzle outer diameter, which will safely fit within the allowable component spacing, is 7 mm.

BOTTOM SIDE/ FIRST SIDE ASSEMBLY

This module is not recommended for assembly on the bottom side of a customer board. If such an assembly is attempted, components may fall off the module during the second reflow process.

LEAD FREE SOLDERING

The SLIN-12F2Ax modules are lead-free (Pb-free) and RoHS compliant and are both forward and backward compatible in a Pb-free and a SnPb soldering process. Failure to observe the instructions may result in the failure of or cause damage to the modules and can adversely affect long-term reliability.

PB-FREE REFLOW PROFILE

Power Systems will comply with J-STD-020 Rev. C (Moisture/Reflow Sensitivity Classification for Nonhermetic Solid State Surface Mount Devices) for both Pb-free solder profiles and MSL classification procedures. This standard provides a recommended forced-air-convection reflow profile based on the volume and thickness of the package. The suggested Pb-free solder paste is Sn/Ag/Cu (SAC). A 6 mil thick stencil is recommended. The recommended linear reflow profile using Sn/Ag/Cu solder is shown below. Soldering outside of the recommended profile requires testing to verify results and performance.

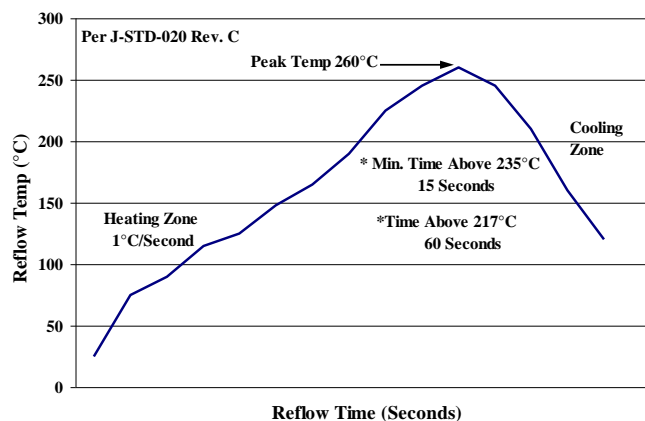

Figure 50. Recommended linear reflow profile using Sn/Ag/Cu solder.

MSL RATING

The SLIN-12F2Ax modules have a MSL rating of 2 A.

STORAGE AND HANDLING

The recommended storage environment and handling procedures for moisture-sensitive surface mount packages is detailed in J-STD-033 Rev. A (Handling, Packing, Shipping and Use of Moisture/Reflow Sensitive Surface Mount Devices). Moisture barrier bags (MBB) with desiccant are required for MSL ratings of 2 or greater. These sealed packages should not be broken until time of use. Once the original package is broken, the floor life of the product at conditions of $\leq 30^{\circ}\text{C}$ and 60% relative humidity varies according to the MSL rating (see J-STD-033A). The shelf life for dry packed SMT packages will be a minimum of 12 months from the bag seal date, when stored at the following conditions: $< 40^{\circ}\text{C}$, $< 90\%$ relative humidity.

POST SOLDER CLEANING AND DRYING CONSIDERATIONS

Post solder cleaning is usually the final circuit board assembly process prior to electrical board testing. The result of inadequate cleaning and drying can affect both the reliability of a power module and the testability of the finished circuit board assembly.



Asia-Pacific
+86 755 298 85888

Europe, Middle East
+353 61 49 8941

North America
+1 866 513 2839

30. REVISION HISTORY

DATE	REVISION	CHANGES DETAIL	APPROVAL
2010-04-14	A	First release.	T. Bubriski
2010-12-02	B	Updated the Remote ON/OFF table on page 13. Updated Surface Mount Information on page 24. Updated Ripple and Noise on page 3.	T. Bubriski
2012-06-26	C	Add label.	HL.Lu
2013-01-25	D	Update UL.	HL.Lu
2015-07-17	E	Update Part Selection, MSL Rating.	XF.Jiang
2021-08-09	AF	Add object ID and module photo. Update safety certificate. Update to new format.	XF.Jiang

For more information on these products consult: tech.support@psbel.com

NUCLEAR AND MEDICAL APPLICATIONS - Products are not designed or intended for use as critical components in life support systems, equipment used in hazardous environments, or nuclear control systems.

TECHNICAL REVISIONS - The appearance of products, including safety agency certifications pictured on labels, may change depending on the date manufactured. Specifications are subject to change without notice.



tech.support@psbel.com
belfuse.com/power-solutions