

Data sheet | Item number: 280-686

4-conductor carrier terminal block; for DIN-rail 35 x 15 and 35 x 7.5; 2.5 mm²; CAGE CLAMP®; 2,50 mm²; gray

www.wago.com/280-686

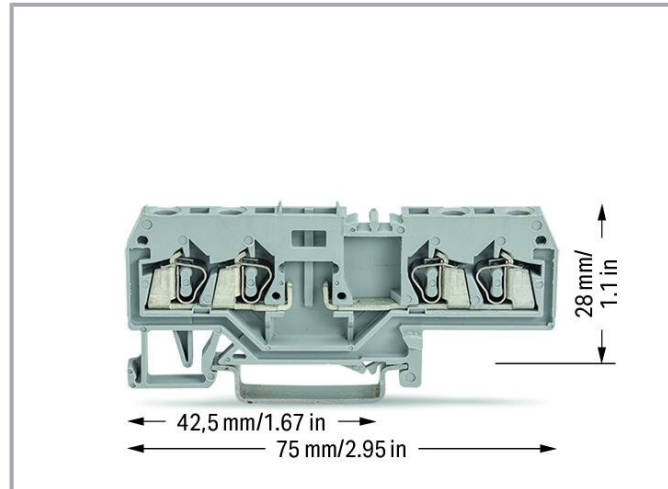
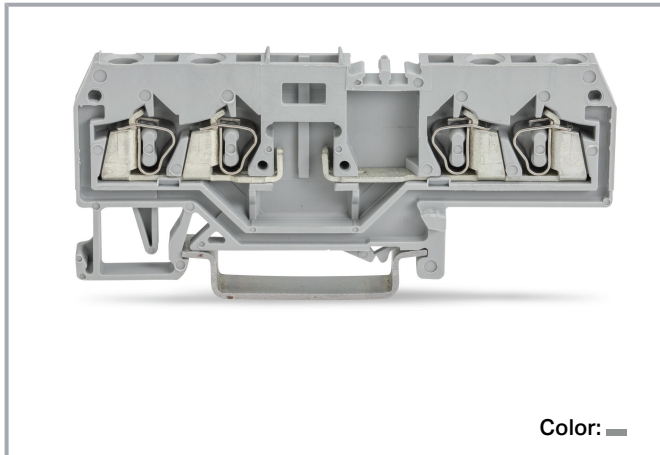

Data

Electrical data

Ratings per IEC/EN

Ratings per	IEC/EN 60947-7-1
Nominal voltage (III/3)	400 V
Rated impulse voltage (III/3)	6 kV
Rated current	10 A
Legend (ratings)	(III / 3) ≙ Overvoltage category III / Pollution degree 3

Power loss

Power loss, per pole (potential)	0.133 W
Rated current I_N for specified power loss	10 A
Resistance value for specified, current-dependent power loss	0.001 Ω

Connection data

Connection points	4
Total number of potentials	2
Number of levels	1

Subject to changes. Please also observe the further product documentation!

WAGO GmbH & Co. KG
Hansastr. 27
32423 Minden
Phone: +49571 887-0 | Fax: +49571 887-169
Email: info.de@wago.com | Web: www.wago.com

Do you have any questions about our products?
We are always happy to take your call at +49 (571) 887-44222.



Connection 1

Connection technology	CAGE CLAMP®
Actuation type	Operating tool
Connectable conductor materials	Copper Aluminum
Connectable conductor materials (note)	<p>Terminating Aluminum Conductors WAGO spring clamp terminal blocks are suitable for solid aluminum conductors up to 4 mm²/12 AWG if WAGO "Alu-Plus" Contact Paste 249-130 is used for termination.</p> <p>"Alu-Plus" Contact Paste Advantages:</p> <ul style="list-style-type: none"> ■ Automatically destroys the oxide film during clamping. ■ Prevents fresh oxidation at the clamping point. ■ Prevents electrolytic corrosion between aluminum and copper conductors (in the same terminal block). ■ Provides long-term protection against corrosion. <p>Using terminal blocks with CAGE CLAMP® Spring Pressure Connection Technology, aluminum conductors must first be cleaned with a blade and then immediately be inserted into the clamping units filled with "Alu-Plus" Contact Paste.</p> <p>It is also possible to apply WAGO "Alu-Plus" additionally on the whole surface of the aluminum conductor before termination.</p> <p>Please note that the nominal currents must be adapted to the reduced conductivity of the aluminum conductors:: 2.5 mm² = 16 A 4 mm² = 22 A</p>
Solid conductor	0.08 ... 2.5 mm ² / 28 ... 12 AWG
Fine-stranded conductor	0.08 ... 2.5 mm ² / 28 ... 12 AWG
Note (conductor cross-section)	12 AWG: THHN, THWN
Strip length	8 ... 9 mm / 0.31 ... 0.35 inches
Wiring direction	Front-entry wiring

Physical data

Width	5 mm / 0.197 inches
Height	75 mm / 2.953 inches

Subject to changes. Please also observe the further product documentation!

WAGO GmbH & Co. KG
Hansastr. 27
32423 Minden
Phone: +49571 887-0 | Fax: +49571 887-169
Email: info.de@wago.com | Web: www.wago.com

Do you have any questions about our products?
We are always happy to take your call at +49 (571) 887-44222.



Depth from upper-edge of DIN-rail	28 mm / 1.102 inches
-----------------------------------	----------------------

Mechanical Data

Design	horizontal type
Mounting type	DIN-35 rail
Marking level	Center marking

Material Data

Note (material data)	Information on material specifications can be found here
----------------------	--------------------------------------------------------------------------

Color	gray
Material group	I
Insulation material	Polyamide (PA66)
Flammability class per UL94	V0
Fire load	0.234 MJ
Weight	9.1 g

Environmental requirements

Processing temperature	-35 ... +85 °C
Continuous operating temperature	-60 ... +105 °C

Commercial data

Product Group	1 (Rail Mounted Terminal Blocks)
eCl@ss 10.0	27-14-11-20
eCl@ss 9.0	27-14-11-20
ETIM 8.0	EC000897
ETIM 7.0	EC000897
PU (SPU)	100 pcs
Packaging type	box
Country of origin	DE
GTIN	4044918556842
Customs tariff number	85369010000



Environmental Product Compliance

RoHS Compliance Status	Compliant, No Exemption
------------------------	-------------------------



Subject to changes. Please also observe the further product documentation!

Approvals / Certificates



General approvals

Logo	Approval	Additional Approval Text	Certificate name
	CCA DEKRA Certification B.V.	EN 60947	2157201.01
	CSA DEKRA Certification B.V.	C22.2	1536071
	UL Underwriters Laboratories Inc.	UL 1059	E45172

Declarations of conformity and manufacturer's declarations

Logo	Approval	Additional Approval Text	Certificate name
	EU-Declaration of Conformity WAGO GmbH & Co. KG	-	-
	UK-Declaration of Conformity WAGO GmbH & Co. KG	-	-

Approvals for marine applications

Logo	Approval	Additional Approval Text	Certificate name
	ABS American Bureau of Shipping	EN 60947	20- HG1941090- PDA
	BV Bureau Veritas S.A.	EN 60947	07436/F0 BV
	DNV GL Det Norske Veritas, Germanischer Lloyd	-	TAE00001V2

Subject to changes. Please also observe the further product documentation!

WAGO GmbH & Co. KG
 Hansastr. 27
 32423 Minden
 Phone: +49571 887-0 | Fax: +49571 887-169
 Email: info.de@wago.com | Web: www.wago.com

Do you have any questions about our products?
 We are always happy to take your call at +49 (571) 887-44222.



LR
Lloyds Register

EN 60947

91/20112
(E9)

Required accessories

End plate









End plate

	Item no.: 280-314 End and intermediate plate; 2.5 mm thick; gray	www.wago.com/280-314
	Item no.: 280-315 End and intermediate plate; 2.5 mm thick; orange	www.wago.com/280-315

Optional accessories

Carrier rail

Mounting accessories

	Item no.: 210-197 Steel carrier rail; 35 x 15 mm; 1.5 mm thick; 2 m long; slotted; similar to EN 60715; silver-colored	www.wago.com/210-197
	Item no.: 210-198 Copper carrier rail; 35 x 15 mm; 2.3 mm thick; 2 m long; unslotted; according to EN 60715; copper-colored	www.wago.com/210-198
	Item no.: 210-504 Steel carrier rail; 35 x 7.5 mm; 1 mm thick; 2 m long; slotted; galvanized; according to EN 60715; silver-colored	www.wago.com/210-504
	Item no.: 210-505 Steel carrier rail; 35 x 7.5 mm; 1 mm thick; 2 m long; unslotted; galvanized; according to EN 60715; silver-colored	www.wago.com/210-505
	Item no.: 210-506 Steel carrier rail; 35 x 15 mm; 1.5 mm thick; 2 m long; unslotted; galvanized; similar to EN 60715; silver-colored	www.wago.com/210-506
	Item no.: 210-508 Steel carrier rail; 35 x 15 mm; 1.5 mm thick; 2 m long; slotted; galvanized; similar to EN 60715; silver-colored	www.wago.com/210-508
	Item no.: 210-113 Steel carrier rail; 35 x 7.5 mm; 1 mm thick; 2 m long; unslotted; according to EN 60715; silver-colored	www.wago.com/210-113
	Item no.: 210-118 Steel carrier rail; 35 x 15 mm; 2.3 mm thick; 2 m long; unslotted; according to EN 60715; silver-colored	www.wago.com/210-118

Item no.: 210-112

Subject to changes. Please also observe the further product documentation!

WAGO GmbH & Co. KG
Hansastr. 27
32423 Minden
Phone: +49571 887-0 | Fax: +49571 887-169
Email: info.de@wago.com | Web: www.wago.com

Do you have any questions about our products?
We are always happy to take your call at +49 (571) 887-44222.



Steel carrier rail; 35 x 7.5 mm; 1 mm thick; 2 m long; slotted; according to EN 60715; "Hole width 25 mm; www.wago.com/210-112
silver-colored



Item no.: 210-114
Steel carrier rail; 35 x 15 mm; 1.5 mm thick; 2 m long; unslotted; similar to EN 60715; silver-colored www.wago.com/210-114



Item no.: 210-115
Steel carrier rail; 35 x 7.5 mm; 1 mm thick; 2 m long; slotted; according to EN 60715; "Hole width 18 mm; www.wago.com/210-115
silver-colored



Item no.: 210-196
Aluminum carrier rail; 35 x 8.2 mm; 1.6 mm thick; 2 m long; unslotted; similar to EN 60715; silver-colored www.wago.com/210-196

Tool

Operating tool



Item no.: 210-657
Operating tool; Blade: 3.5 x 0.5 mm; with a partially insulated shaft; short; multicoloured www.wago.com/210-657



Item no.: 210-658
Operating tool; Blade: 3.5 x 0.5 mm; with a partially insulated shaft; angled; short; multicoloured www.wago.com/210-658



Item no.: 210-720
Operating tool; Blade: 3.5 x 0.5 mm; with a partially insulated shaft; multicoloured www.wago.com/210-720

Protective warning marker

Cover



Item no.: 280-415
Protective warning marker; for 5 terminal blocks; with high-voltage symbol, black; yellow www.wago.com/280-415

Insulation stop

Insulation stop



Item no.: 280-472
Insulation stop; 0.75 - 1 mm²; 5 pieces/strip; black www.wago.com/280-472



Item no.: 280-470
Insulation stop; 0.08 - 0.2 mm² "s" (0.14 mm² "f-st"); 5 pieces/strip; white www.wago.com/280-470



Item no.: 280-471
Insulation stop; 0.25 - 0.5 mm²; 5 pieces/strip; light gray www.wago.com/280-471











Marking accessories

Marker



Item no.: 2009-115/000-002
WMB-Inline; for Smart Printer; 1500 pieces on roll; stretchable 5 - 5.2 mm; plain; snap-on type; yellow www.wago.com/2009-115/000-002

Subject to changes. Please also observe the further product documentation!

	<p>Item no.: 2009-115/000-007 WMB-Inline; for Smart Printer; 1500 pieces on roll; stretchable 5 - 5.2 mm; plain; snap-on type; gray</p>	<p>www.wago.com/2009-115/000-007</p>
	<p>Item no.: 2009-115/000-017 WMB-Inline; for Smart Printer; 1500 pieces on roll; stretchable 5 - 5.2 mm; plain; snap-on type; light green</p>	<p>www.wago.com/2009-115/000-017</p>
	<p>Item no.: 2009-115/000-023 WMB-Inline; for Smart Printer; 1500 pieces on roll; stretchable 5 - 5.2 mm; plain; snap-on type; green</p>	<p>www.wago.com/2009-115/000-023</p>
	<p>Item no.: 2009-115/000-024 WMB-Inline; for Smart Printer; 1500 pieces on roll; stretchable 5 - 5.2 mm; plain; snap-on type; violet</p>	<p>www.wago.com/2009-115/000-024</p>
	<p>Item no.: 2009-115 WMB-Inline; for Smart Printer; 1500 pieces on roll; stretchable 5 - 5.2 mm; plain; snap-on type; white</p>	<p>www.wago.com/2009-115</p>
	<p>Item no.: 793-5501/000-007 WMB marking card; as card; for terminal block width 5 - 17.5 mm; stretchable 5 - 5.2 mm; plain; snap-on type; gray</p>	<p>www.wago.com/793-5501/000-007</p>
	<p>Item no.: 793-5501/000-012 WMB marking card; as card; for terminal block width 5 - 17.5 mm; stretchable 5 - 5.2 mm; plain; snap-on type; orange</p>	<p>www.wago.com/793-5501/000-012</p>
	<p>Item no.: 793-5501/000-017 WMB marking card; as card; for terminal block width 5 - 17.5 mm; stretchable 5 - 5.2 mm; plain; snap-on type; light green</p>	<p>www.wago.com/793-5501/000-017</p>
	<p>Item no.: 793-5501/000-023 WMB marking card; as card; for terminal block width 5 - 17.5 mm; stretchable 5 - 5.2 mm; plain; snap-on type; green</p>	<p>www.wago.com/793-5501/000-023</p>
	<p>Item no.: 793-5501/000-024 WMB marking card; as card; for terminal block width 5 - 17.5 mm; stretchable 5 - 5.2 mm; plain; snap-on type; violet</p>	<p>www.wago.com/793-5501/000-024</p>
	<p>Item no.: 793-501/000-002 WMB marking card; as card; not stretchable; plain; snap-on type; yellow</p>	<p>www.wago.com/793-501/000-002</p>

Subject to changes. Please also observe the further product documentation!



Item no.: 793-501/000-007
WMB marking card; as card; not stretchable; plain; snap-on type; gray

www.wago.com/793-501/000-007



Item no.: 793-501/000-017
WMB marking card; as card; not stretchable; plain; snap-on type; light green

www.wago.com/793-501/000-017



Item no.: 793-501/000-012
WMB marking card; as card; not stretchable; plain; snap-on type; orange

www.wago.com/793-501/000-012



Item no.: 793-501/000-023
WMB marking card; as card; not stretchable; plain; snap-on type; green

www.wago.com/793-501/000-023



Item no.: 793-501/000-006
WMB marking card; as card; not stretchable; plain; snap-on type; blue

www.wago.com/793-501/000-006



Item no.: 793-501/000-005
WMB marking card; as card; not stretchable; plain; snap-on type; red

www.wago.com/793-501/000-005



Item no.: 793-501
WMB marking card; as card; not stretchable; plain; snap-on type; white

www.wago.com/793-501



Item no.: 793-501/000-024
WMB marking card; as card; not stretchable; plain; snap-on type; violet

www.wago.com/793-501/000-024



Item no.: 793-5501/000-005
WMB marking card; as card; for terminal block width 5 - 17.5 mm; stretchable 5 - 5.2 mm; plain; snap-on type; red

www.wago.com/793-5501/000-005



Item no.: 793-5501/000-002
WMB marking card; as card; for terminal block width 5 - 17.5 mm; stretchable 5 - 5.2 mm; plain; snap-on type; yellow



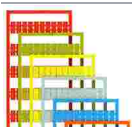







www.wago.com/793-5501/000-002















Item no.: 793-5501/000-006
WMB marking card; as card; for terminal block width 5 - 17.5 mm; stretchable 5 - 5.2 mm; plain; snap-on type; blue

www.wago.com/793-5501/000-006

Subject to changes. Please also observe the further product documentation!

	Item no.: 793-5501 WMB marking card; as card; for terminal block width 5 - 17.5 mm; stretchable 5 - 5.2 mm; plain; snap-on type; white	www.wago.com/793-5501
	Item no.: 2009-115/000-012 WMB-Inline; for Smart Printer; 1500 pieces on roll; stretchable 5 - 5.2 mm; plain; snap-on type; orange	www.wago.com/2009-115/000-012
	Item no.: 2009-115/000-006 WMB-Inline; for Smart Printer; 1500 pieces on roll; stretchable 5 - 5.2 mm; plain; snap-on type; blue	www.wago.com/2009-115/000-006
Plugs		
Component module with a fuse		
	Item no.: 286-890 Component module with fuse; for (5 x 20) mm microfuse; Nominal voltage: 24 VAC/DC; gray	www.wago.com/286-890
	Item no.: 286-891 Component module with fuse; for (5 x 20) mm microfuse; Nominal voltage: 230 VAC/DC; gray	www.wago.com/286-891
Neon indicator module		
	Item no.: 280-801/281-417 Component plug; for carrier terminal blocks; 2-pole; 5 mm wide; gray	www.wago.com/280-801/281-417
	Item no.: 280-801/281-418 Component plug; for carrier terminal blocks; 2-pole; 5 mm wide; gray	www.wago.com/280-801/281-418
Solid-state relay module		
	Item no.: 286-721 Optocoupler module; Nominal input voltage: 24 VDC; Output voltage range: 15 ... 30 VDC; Limiting continuous current: 5 A; 3-wire connection/low-side switching; Red status indicator; Module width: 15 mm; gray	www.wago.com/286-721
	Item no.: 286-723 Optocoupler module; Nominal input voltage: 24 VDC; Output voltage range: 15 ... 30 VDC; Limiting continuous current: 4 A; 3-wire connection/high-side switching; Red status indicator; Module width: 15 mm; gray	www.wago.com/286-723
	Item no.: 286-752 Optocoupler module; Nominal input voltage: 24 VDC; Output voltage range: 20 ... 30 VDC; Limiting continuous current: 0.5 A; 3-wire connection/high-side switching; Frequency: 25 kHz; Red status indicator; Module width: 15 mm; gray	www.wago.com/286-752
	Item no.: 286-752/002-000 Optocoupler module; Red status indicator; gray	www.wago.com/286-752/002-000
	Item no.: 286-792 Optocoupler module; Red status indicator; gray	www.wago.com/286-792
	Item no.: 286-794 Optocoupler module; Nominal input voltage: 24 VDC; Red status indicator; gray	www.wago.com/286-794

Subject to changes. Please also observe the further product documentation!

	Item no.: 286-791 Optocoupler module; Nominal input voltage: 24 VDC; Output voltage range: 20 ... 60 VDC; Limiting continuous current: 0.1 A; 2-wire connection; Frequency: 3 kHz; Red status indicator; Module width: 10 mm; gray	www.wago.com/286-791
Component module with diode		
	Item no.: 286-805 Component module with diode; with 5 pcs; Diode 1N4007; with common anode; gray	www.wago.com/286-805
	Item no.: 286-807 Component module with diode; with 7 pcs; Diode 1N4007; with common anode; gray	www.wago.com/286-807
	Item no.: 286-809 Component module with diode; with 9 pcs; Diode 1N4007; with common anode; gray	www.wago.com/286-809
Timer relay module		
	Item no.: 286-604/004-000 Timer relay module; Nominal input voltage: 24 VDC; Limiting continuous current: 6 A; On-delay: 10 ... 100 s; Red status indicator; Module width: 20 mm; gray	www.wago.com/286-604/004-000
	Item no.: 286-640/004-000 Timer relay module; Nominal input voltage: 24 VDC; Limiting continuous current: 5 A; Railway; Multifunction; Red status indicator; Module width: 20 mm; gray	www.wago.com/286-640/004-000
	Item no.: 286-640 Timer relay module; Nominal input voltage: 24 VDC; Limiting continuous current: 6 A; Railway; Multifunction/Multitime; Yellow status indicator; Module width: 6 mm; gray	www.wago.com/286-640
LED plug		
	Item no.: 280-801/281-413 Component plug; for carrier terminal blocks; 2-pole; LED (red); 24 VDC; 5 mm wide; gray	www.wago.com/280-801/281-413
	Item no.: 280-801/281-414 Component plug; for carrier terminal blocks; 2-pole; LED (red); 48 VDC; 5 mm wide; gray	www.wago.com/280-801/281-414
	Item no.: 280-801/281-415 Component plug; for carrier terminal blocks; 2-pole; LED (red); 5 mm wide; gray	www.wago.com/280-801/281-415
	Item no.: 280-801/281-416 Component plug; for carrier terminal blocks; 2-pole; LED (red); 5 mm wide; gray	www.wago.com/280-801/281-416
Bridge rectifier module		
	Item no.: 286-830 Bridge rectifier module; Input voltage: 24 VAC; with varistor protective circuit; gray	www.wago.com/286-830
Current flow monitoring module		
	Item no.: 286-664 Current flow monitoring module; AC currents; Monitoring range: 0.2 A – 3 A; 1 changeover contact; light gray	www.wago.com/286-664

Subject to changes. Please also observe the further product documentation!

	Item no.: 286-665 Current flow monitoring module; AC currents; Monitoring range: 1 A – 10 A; 1 changeover contact; light gray	www.wago.com/286-665
	Item no.: 286-662 Current flow monitoring module; DC currents; Monitoring range: 0.4 A – 3.5 A; 1 make contact; light gray	www.wago.com/286-662
	Item no.: 286-661 Current flow monitoring module; AC currents; light gray	www.wago.com/286-661
Switching module		
	Item no.: 286-896 Switching module; with momentary switch; Switching voltage: 250 VAC; Switching current: 6 A; gray	www.wago.com/286-896
	Item no.: 286-895 Switching module; with changeover rocker switch; Switching voltage: 250 VAC; Switching current: 6 A; gray	www.wago.com/286-895
Fuse plug		
	Item no.: 280-854/281-413 Fuse plug; with soldered miniature fuse; with indicator lamp; LED (red); DC 15 - 30 V; 1 A FF; 5 mm wide; gray	www.wago.com/280-854/281-413
	Item no.: 280-854/281-415 Fuse plug; with soldered miniature fuse; with indicator lamp; LED (red); AC 15 - 30 V; 1 A FF; 5 mm wide; gray	www.wago.com/280-854/281-415
	Item no.: 280-856/281-415 Fuse plug; with soldered miniature fuse; with indicator lamp; LED (red); AC 15 - 30 V; 2 A FF; 5 mm wide; gray	www.wago.com/280-856/281-415
	Item no.: 280-856/281-414 Fuse plug; with soldered miniature fuse; with indicator lamp; LED (red); DC 30 - 65 V; 2 A FF; 5 mm wide; gray	www.wago.com/280-856/281-414
	Item no.: 280-856 Fuse plug; with soldered miniature fuse; 2 A FF; 5 mm wide; gray	www.wago.com/280-856
	Item no.: 280-854/281-414 Fuse plug; with soldered miniature fuse; with indicator lamp; LED (red); DC 30 - 65 V; 1 A FF; 5 mm wide; gray	www.wago.com/280-854/281-414
	Item no.: 280-856/281-413 Fuse plug; with soldered miniature fuse; with indicator lamp; LED (red); DC 15 - 30 V; 2 A FF; 5 mm wide; gray	www.wago.com/280-856/281-413
	Item no.: 280-850/281-414 Fuse plug; with soldered miniature fuse; with indicator lamp; LED (red); DC 30 - 65 V; 250 mA FF; 5 mm wide; gray	www.wago.com/280-850/281-414
	Item no.: 280-850/281-413 Fuse plug; with soldered miniature fuse; with indicator lamp; LED (red); DC 15 - 30 V; 250 mA FF; 5 mm wide; gray	www.wago.com/280-850/281-413

Subject to changes. Please also observe the further product documentation!

	Item no.: 280-850/281-415 Fuse plug; with soldered miniature fuse; with indicator lamp; LED (red); AC 15 - 30 V; 250 mA FF; 5 mm wide; gray	www.wago.com/280-850/281-415
---------------------------------------------------------------------------------	-------------------------------------------------------------------------------------------------------------------------------------------------------	--------------------------------------------------------------------------------

	Item no.: 280-852/281-413 Fuse plug; with soldered miniature fuse; with indicator lamp; LED (red); DC 15 - 30 V; 500 mA FF; 5 mm wide; gray	www.wago.com/280-852/281-413
---------------------------------------------------------------------------------	-------------------------------------------------------------------------------------------------------------------------------------------------------	--------------------------------------------------------------------------------

	Item no.: 280-852/281-414 Fuse plug; with soldered miniature fuse; with indicator lamp; LED (red); DC 30 - 65 V; 500 mA FF; 5 mm wide; gray	www.wago.com/280-852/281-414
---------------------------------------------------------------------------------	-------------------------------------------------------------------------------------------------------------------------------------------------------	--------------------------------------------------------------------------------

	Item no.: 280-852/281-415 Fuse plug; with soldered miniature fuse; with indicator lamp; LED (red); AC 15 - 30 V; 500 mA FF; 5 mm wide; gray	www.wago.com/280-852/281-415
---------------------------------------------------------------------------------	-------------------------------------------------------------------------------------------------------------------------------------------------------	--------------------------------------------------------------------------------

	Item no.: 280-854 Fuse plug; with soldered miniature fuse; 1 A FF; 5 mm wide; gray	www.wago.com/280-854
---------------------------------------------------------------------------------	----------------------------------------------------------------------------------------------	----------------------------------------------------------------

	Item no.: 280-852 Fuse plug; with soldered miniature fuse; 500 mA FF; 5 mm wide; gray	www.wago.com/280-852
---------------------------------------------------------------------------------	-------------------------------------------------------------------------------------------------	----------------------------------------------------------------

	Item no.: 280-850 Fuse plug; with soldered miniature fuse; 250 mA FF; 5 mm wide; gray	www.wago.com/280-850
---------------------------------------------------------------------------------	-------------------------------------------------------------------------------------------------	----------------------------------------------------------------

Diode plug

	Item no.: 280-801/281-411 Component plug; for carrier terminal blocks; 2-pole; with diode 1N4007; 5 mm wide; gray	www.wago.com/280-801/281-411
---------------------------------------------------------------------------------	-----------------------------------------------------------------------------------------------------------------------------	--------------------------------------------------------------------------------

	Item no.: 280-801/281-421 Component plug; for carrier terminal blocks; 2-pole; with LED and recovery diode; 5 mm wide; gray	www.wago.com/280-801/281-421
-----------------------------------------------------------------------------------	---------------------------------------------------------------------------------------------------------------------------------------	--------------------------------------------------------------------------------

	Item no.: 280-801/281-420 Component plug; for carrier terminal blocks; 2-pole; with LED and recovery diode; 5 mm wide; gray	www.wago.com/280-801/281-420
-----------------------------------------------------------------------------------	---------------------------------------------------------------------------------------------------------------------------------------	--------------------------------------------------------------------------------

Component module with LED

	Item no.: 286-822 Component module with LED; Red LED; with common cathode	www.wago.com/286-822
-----------------------------------------------------------------------------------	-------------------------------------------------------------------------------------	----------------------------------------------------------------

AND gate module

	Item no.: 286-826 AND gate module with 6 inputs; light gray	www.wago.com/286-826
-----------------------------------------------------------------------------------	-----------------------------------------------------------------------	----------------------------------------------------------------

Relay module

	Item no.: 286-307/004-000 Relay module; Nominal input voltage: 110 VDC; 1 changeover contact; Limiting continuous current: 3 A; Railway; Red status indicator; Module width: 15 mm; gray	www.wago.com/286-307/004-000
-----------------------------------------------------------------------------------	----------------------------------------------------------------------------------------------------------------------------------------------------------------------------------------------------	--------------------------------------------------------------------------------

	Item no.: 286-328/004-000
-----------------------------------------------------------------------------------	----------------------------------

Subject to changes. Please also observe the further product documentation!

Relay module; Nominal input voltage: 24 VDC; 2 make contact; Limiting continuous current: 6 A;
Railway; Red status indicator; Module width: 20 mm; gray

www.wago.com/286-328/004-000

 **Item no.: 286-312**
Relay module; Nominal input voltage: 24 VDC; 2 changeover contacts; Limiting continuous current: 7 A; www.wago.com/286-312
Red status indicator; Module width: 20 mm; gray

 **Item no.: 286-328**
Relay module; Nominal input voltage: 24 VDC; 2 make contact; Limiting continuous current: 6 A; Red www.wago.com/286-328
status indicator; Module width: 20 mm; gray

 **Item no.: 286-312/004-000**
Relay module; Nominal input voltage: 24 VDC; 2 changeover contacts; Limiting continuous current: 5 A; www.wago.com/286-312/004-000
Railway; Red status indicator; Module width: 20 mm; gray

 **Item no.: 286-316**
Relay module; Nominal input voltage: 220 VDC; 2 changeover contacts; Limiting continuous current: 7 www.wago.com/286-316
A; Red status indicator; Module width: 20 mm; gray

 **Item no.: 286-320**
Relay module; Nominal input voltage: 24 VDC; 1 break and 1 make contact; Limiting continuous current: www.wago.com/286-320
6 A; Red status indicator; Module width: 20 mm; gray

 **Item no.: 286-336/001-000**
Relay module; Nominal input voltage: 24 VDC; 2 break and 2 make contacts; Red status indicator; www.wago.com/286-336/001-000
Module width: 25 mm; gray

 **Item no.: 286-352/004-000**
Relay module; Nominal input voltage: 24 VDC; 4 make contacts; Limiting continuous current: 5 A; www.wago.com/286-352/004-000
Railway; Red status indicator; Module width: 25 mm; gray

 **Item no.: 286-344/004-000**
Relay module; Nominal input voltage: 24 VDC; 3 break contacts and 1 make contact; Railway; Red www.wago.com/286-344/004-000
status indicator; Module width: 25 mm; gray

 **Item no.: 286-364/004-000**
Relay module; Nominal input voltage: 24 VDC; 1 make contact; Limiting continuous current: 3 A; www.wago.com/286-364/004-000
Railway; Red status indicator; Module width: 10 mm; gray

 **Item no.: 286-368/004-000**
Relay module; Nominal input voltage: 24 VDC; 1 break contact; Limiting continuous current: 3 A; www.wago.com/286-368/004-000
Railway; Red status indicator; Module width: 10 mm; gray

 **Item no.: 286-364**
Relay module; Nominal input voltage: 24 VDC; 1 make contact; Limiting continuous current: 5 A; Red www.wago.com/286-364
status indicator; Module width: 10 mm; gray

 **Item no.: 286-376**
Relay module; Nominal input voltage: 24 VDC; 1 make contact; Limiting continuous current: 5 A; for www.wago.com/286-376
switching higher DC loads; Red status indicator; Module width: 15 mm; gray











 **Item no.: 286-368**
Relay module; Nominal input voltage: 24 VDC; 1 break contact; Limiting continuous current: 5 A; Red www.wago.com/286-368
status indicator; Module width: 10 mm; gray

 **Item no.: 286-394/004-000**

Subject to changes. Please also observe the further product documentation!

Relay module; Nominal input voltage: 24 VDC; 1 changeover contact; Limiting continuous current: 1 A; with gold contacts; Railway; Red status indicator; Module width: 15 mm; light gray

www.wago.com/286-394/004-000

	Item no.: 286-380 Bistable relay module; Nominal input voltage: 24 VDC; 1 changeover contact; Limiting continuous current: 6 A; Red status indicator; Module width: 15 mm; gray	www.wago.com/286-380
	Item no.: 286-320/004-000 Relay module; Nominal input voltage: 24 VDC; 1 break and 1 make contact; Railway; Red status indicator; Module width: 20 mm; gray	www.wago.com/286-320/004-000
	Item no.: 286-573 Latching relay module; Nominal input voltage: 24 VDC; 1 changeover contact; Limiting continuous current: 6 A; Red status indicator; Module width: 15 mm	www.wago.com/286-573
	Item no.: 286-304 Relay module; Nominal input voltage: 24 VDC; 1 changeover contact; Limiting continuous current: 7 A; Red status indicator; Module width: 15 mm; gray	www.wago.com/286-304
	Item no.: 286-304/004-000 Relay module; Nominal input voltage: 24 VDC; 1 changeover contact; Limiting continuous current: 6 A; Railway; Red status indicator; Module width: 15 mm; gray	www.wago.com/286-304/004-000
	Item no.: 286-508 Relay module; Nominal input voltage: 230 VAC; 1 changeover contact; Limiting continuous current: 7 A; Red status indicator; Module width: 15 mm; gray	www.wago.com/286-508
	Item no.: 286-507 Relay module; Nominal input voltage: 115 VAC; 1 changeover contact; Limiting continuous current: 7 A; Red status indicator; Module width: 15 mm; gray	www.wago.com/286-507
	Item no.: 286-516 Relay module; Nominal input voltage: 230 VAC; 2 changeover contacts; Limiting continuous current: 7 A; Red status indicator; Module width: 15 mm; gray	www.wago.com/286-516
S0 interface power supply unit		
	Item no.: 286-742 S0 interface power supply; Input voltage: 230 VAC; S0 interface	www.wago.com/286-742
Empty component plug housing		
	Item no.: 280-801 Empty component plug housing; gray	www.wago.com/280-801
	Item no.: 280-802 Empty component plug housing; gray	www.wago.com/280-802
	Item no.: 280-804 Empty component plug housing; 10 mm wide; Type 3; 4-pole; gray	www.wago.com/280-804
	Item no.: 286-112 Empty component plug housing; Type 11; 20 mm wide; 8-pole; gray	www.wago.com/286-112
	Item no.: 286-113 Empty component plug housing; Type 12; 25 mm wide; 10-pole; gray	www.wago.com/286-113

Subject to changes. Please also observe the further product documentation!

Item no.: 286-110

Empty component plug housing; Type 9; 10 mm wide; 4-pole; gray

www.wago.com/286-110

Item no.: 286-111

Empty component plug housing; Type 10; 15 mm wide; 6-pole; gray

www.wago.com/286-111

Mounting

Mounting accessories



Item no.: 209-106

Mounting carrier; for isolated mounting on DIN 35 rails; gray

www.wago.com/209-106

Item no.: 249-116

Screwless end stop; 6 mm wide; for DIN-rail 35 x 15 and 35 x 7.5; gray

www.wago.com/249-116

Ferrule

Ferrule



Item no.: 216-101

Ferrule; Sleeve for 0.5 mm² / AWG 22; uninsulated; electro-tin plated; silver-coloredwww.wago.com/216-101

Item no.: 216-104

Ferrule; Sleeve for 1.5 mm² / AWG 16; uninsulated; electro-tin plated; silver-coloredwww.wago.com/216-104

Item no.: 216-102

Ferrule; Sleeve for 0.75 mm² / AWG 20; uninsulated; electro-tin plated; silver-coloredwww.wago.com/216-102

Item no.: 216-103

Ferrule; Sleeve for 1 mm² / AWG 18; uninsulated; electro-tin platedwww.wago.com/216-103

Item no.: 216-203

Ferrule; Sleeve for 1 mm² / AWG 18; insulated; electro-tin plated; redwww.wago.com/216-203

Item no.: 216-202

Ferrule; Sleeve for 0.75 mm² / 18 AWG; insulated; electro-tin plated; graywww.wago.com/216-202

Item no.: 216-204

Ferrule; Sleeve for 1.5 mm² / AWG 16; insulated; electro-tin plated; blackwww.wago.com/216-204

Item no.: 216-201

Ferrule; Sleeve for 0.5 mm² / 20 AWG; insulated; electro-tin plated; whitewww.wago.com/216-201

Item no.: 216-301

Ferrule; Sleeve for 0.25 mm² / AWG 24; insulated; electro-tin plated; yellowwww.wago.com/216-301

Item no.: 216-302

Ferrule; Sleeve for 0.34 mm² / 22 AWG; insulated; electro-tin plated; light turquoisewww.wago.com/216-302

Jumpers

Jumper



Item no.: 210-123

Wire commoning chain; insulated; blue

www.wago.com/210-123

Item no.: 210-103

Subject to changes. Please also observe the further product documentation!

WAGO GmbH & Co. KG

Hansastr. 27











32423 Minden

Phone: +49571 887-0 | Fax: +49571 887-169

Email: info.de@wago.com | Web: www.wago.com

Do you have any questions about our products?

We are always happy to take your call at +49 (571) 887-44222.

	Wire commoning chain; insulated; black	www.wago.com/210-103
	Item no.: 280-492 Jumper; 2-way; insulated; gray	www.wago.com/280-492
	Item no.: 280-482 Jumper; 2-way; insulated; gray	www.wago.com/280-482
	Item no.: 280-484 Jumper; 4-way; insulated; gray	www.wago.com/280-484
	Item no.: 280-490 Jumper; 10-way; insulated; gray	www.wago.com/280-490
	Item no.: 280-485 Jumper; 5-way; insulated; gray	www.wago.com/280-485
	Item no.: 280-483 Jumper; 3-way; insulated; gray	www.wago.com/280-483
	Item no.: 709-110 Wire commoning chain; 2.5 mm ² ; insulated; black	www.wago.com/709-110
	Item no.: 709-112 Wire commoning chain; 2.5 mm ² ; insulated; black	www.wago.com/709-112
	Item no.: 709-111 Wire commoning chain; 2.5 mm ² ; insulated; black	www.wago.com/709-111

Downloads

Documentation

Additional Information

Technical Section	pdf	Download
Technical explanations	2.2 MB	

CAD/CAE-Data

CAE data

EPLAN Data Portal 280-686	URL	Download
WSCAD Universe 280-686	URL	Download

71 IKFN Portal 280-686

Subject to changes. Please also observe the further product documentation!

WAGO GmbH & Co. KG
 Hansastr. 27
 32423 Minden
 Phone: +49571 887-0 | Fax: +49571 887-169
 Email: info.de@wago.com | Web: www.wago.com

Do you have any questions about our products?
 We are always happy to take your call at +49 (571) 887-44222.

Data sheet | Item number: 280-686

www.wago.com/280-686



Environmental 280-686

[URL](#)

[Download](#)

CAD data

2D/3D Models 280-686

[URL](#)

[Download](#)

Environmental Product Compliance

Compliance Search

Environmental Product Compliance 280-686

[URL](#)

[Download](#)

4-conductor carrier terminal block; for DIN-rail 35 x 15 and 35 x 7.5; 2.5 mm²; CAGE CLAMP®; 2,50 mm²; gray

Installation Notes

Subject to changes. Please also observe the further product documentation!

WAGO GmbH & Co. KG

Hansastr. 27

32423 Minden

Phone: +49571 887-0 | Fax: +49571 887-169

Email: info.de@wago.com | Web: www.wago.com

Do you have any questions about our products?

We are always happy to take your call at +49 (571) 887-44222.