

## Bidirectional Symmetrical (BiSy) Low Capacitance, Dual-Line ESD Protection Diode in SOT-323

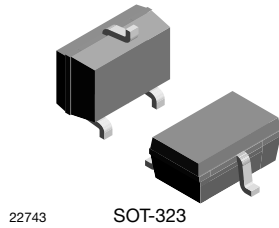
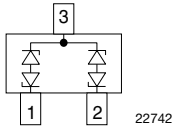

### FEATURES

- For CAN-bus applications
- Small SOT-323 package
- $T_J \text{ max.} = 175 \text{ }^\circ\text{C}$
- 2-line ESD protection
- Working range  $\pm 33 \text{ V}$
- Low leakage current  $I_R < 0.05 \text{ } \mu\text{A}$
- Low load capacitance  $C_D < 9.5 \text{ pF}$
- ESD immunity acc. IEC 61000-4-2  $\pm 30 \text{ kV}$  contact discharge  $\pm 30 \text{ kV}$  air discharge
- ESD capability according to AEC-Q101: human body model: class H3B:  $> 8 \text{ kV}$
- e3 - pins plated with tin (Sn)
- AEC-Q101 qualified available
- Material categorization: for definitions of compliance please see [www.vishay.com/doc?99912](http://www.vishay.com/doc?99912)

**RoHS**  
COMPLIANT

### MARKING (example only)

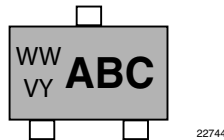

ABC = type code (see table below)  
 WW = date code working week  
 VY = date code year

### LINKS TO ADDITIONAL RESOURCES



ORDERING INFORMATION							
PART NUMBER (EXAMPLE)	ENVIRONMENTAL AND QUALITY CODE			PACKAGING CODE		ORDERING CODE (EXAMPLE)	
	AEC-Q101 QUALIFIED	RoHS-COMPLIANT + LEAD (Pb)-FREE TERMINATIONS		TIN PLATED	3K PER 7" REEL (8 mm TAPE) 15K/BOX = MOQ		10K PER 13" REEL (8 mm TAPE) 10K/BOX = MOQ
		STANDARD	GREEN				
VCAN33A2-03G	-	E		3	-08		VCAN33A2-03G-E3-08
VCAN33A2-03G	H	E		3	-08		VCAN33A2-03GHE3-08
VCAN33A2-03G	-	E		3		-18	VCAN33A2-03G-E3-18
VCAN33A2-03G	H	E		3		-18	VCAN33A2-03GHE3-18

PACKAGE DATA						
DEVICE NAME	PACKAGE NAME	TYPE CODE	WEIGHT	MOLDING COMPOUND FLAMMABILITY RATING	MOISTURE SENSITIVITY LEVEL	SOLDERING CONDITIONS
VCAN33A2-03G	SOT-323	3A2	8.8 mg	UL 94 V-0	MSL level 1 (according J-STD-020)	Peak temperature max. 260 °C

ABSOLUTE MAXIMUM RATINGS					
PARAMETER	TEST CONDITIONS		SYMBOL	VALUE	UNIT
Peak pulse current	$T_A = 25 \text{ }^\circ\text{C}$ , acc. IEC 61000-4-5; $t_p = 8/20 \text{ } \mu\text{s}$ ; single shot		$I_{PPM}$	2.5	A
Peak pulse power	$T_A = 25 \text{ }^\circ\text{C}$ ; pin 1 or 2 to pin 3; acc. IEC 61000-4-5; $t_p = 8/20 \text{ } \mu\text{s}$ ; single shot		$P_{PP}$	140	W
ESD immunity	Contact discharge acc. IEC 61000-4-2; 10 pulses, $T_A = 25 \text{ }^\circ\text{C}$		$V_{ESD}$	$\pm 30$	kV
	Air discharge acc. IEC 61000-4-2; 10 pulses, $T_A = 25 \text{ }^\circ\text{C}$			$\pm 30$	kV
Operating temperature	Junction temperature		$T_J$	-55 to +175	°C
Storage temperature			$T_{STG}$	-55 to +175	°C

**ELECTRICAL CHARACTERISTICS** (pin 1 to 3, 3 to 1, 2 to 3, or 3 to 2)

 ( $T_{amb} = 25\text{ }^{\circ}\text{C}$ , unless otherwise specified)

PARAMETER	TEST CONDITIONS/REMARKS	SYMBOL	MIN.	TYP.	MAX.	UNIT
Protection paths	Number of lines which can be protected	$N_{channel}$	-	-	2	lines
Reverse stand-off voltage	Max. reverse working voltage	$V_{RWM}$	-	-	33	V
Reverse voltage	At $I_R = 0.05\text{ }\mu\text{A}$	$V_R$	33	-	-	V
Reverse current	At $V_{RWM} = 33\text{ V}$	$I_R$	-	-	0.05	$\mu\text{A}$
Reverse breakdown voltage	At $I_R = 1\text{ mA}$	$V_{BR}$	36	38	40	V
Reverse clamping voltage	At $I_{PP} 1\text{ A}$ ; $t_p = 8/20\text{ }\mu\text{s}$	$V_C$	-	42	46	V
	At $I_{PP} = I_{PPM} = 2.5\text{ A}$ ; $t_p = 8/20\text{ }\mu\text{s}$	$V_C$	-	50	56	V
Capacitance	At $V_R = 0\text{ V}$ , $f = 1\text{ MHz}$	$C_D$	-	8.4	9.5	pF
	Diode capacitance matching at $V_R = 0\text{ V}$ , $C_{D13}$ vs. $C_{D23}$	$C_D$	-	-	1	pF

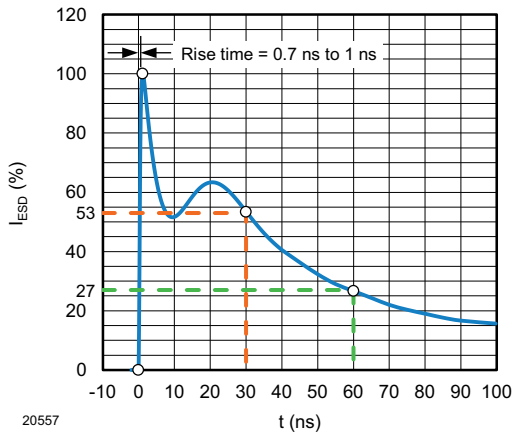
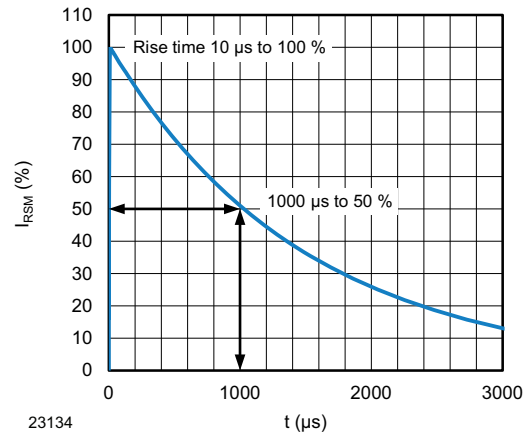
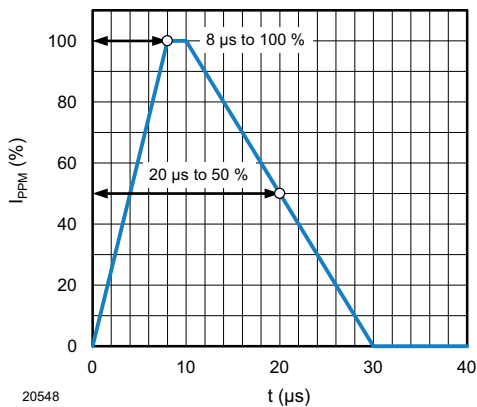
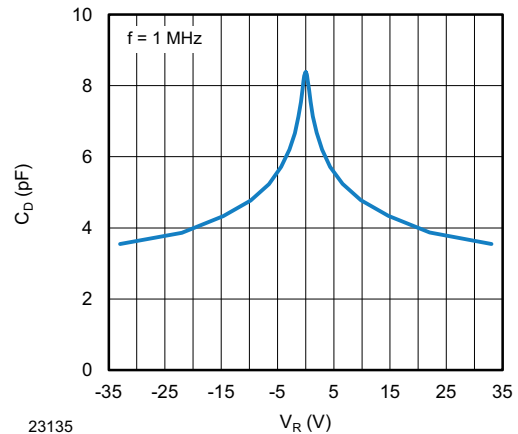
**TYPICAL CHARACTERISTICS** ( $T_{amb} = 25\text{ }^{\circ}\text{C}$ , unless otherwise specified)

 Fig. 1 - ESD Discharge Current Wave Form acc. IEC 61000-4-2 (330  $\Omega$  / 150 pF)

 Fig. 3 - 10/1000  $\mu\text{s}$  Peak Pulse Current Wave Form

 Fig. 2 - 8/20  $\mu\text{s}$  Peak Pulse Current Wave Form acc. IEC 61000-4-5

 Fig. 4 - Typical Capacitance  $C_D$  vs. Reverse Voltage  $V_R$

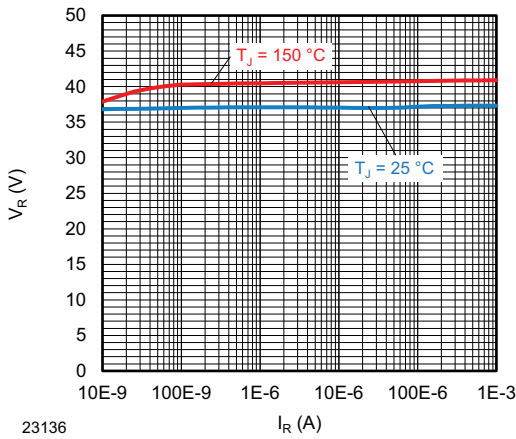

Fig. 5 - Typical Reverse Voltage  $V_R$  vs. Reverse Current  $I_R$

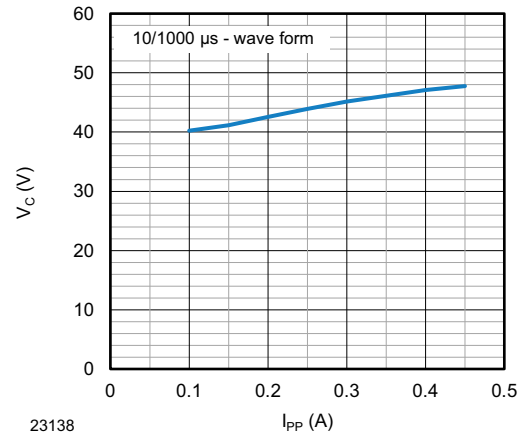

Fig. 7 - Typical Peak Clamping Voltage  $V_{C-TLP}$  vs. Peak Pulse Current  $I_{TLP}$

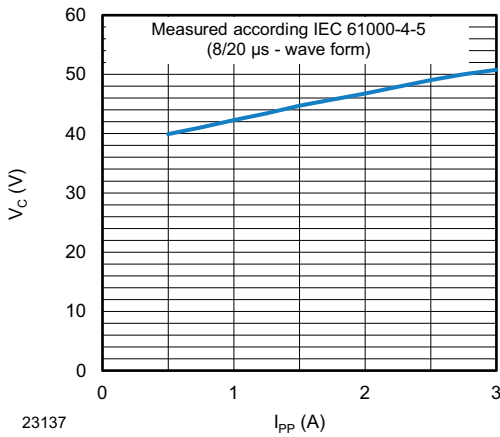

Fig. 6 - Typical Peak Clamping Voltage  $V_C$  vs. Peak Pulse Current  $I_{PP}$

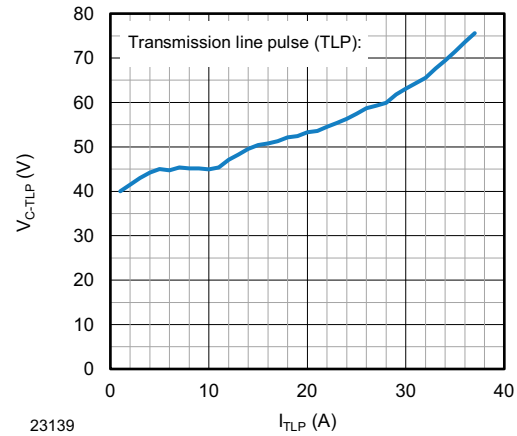
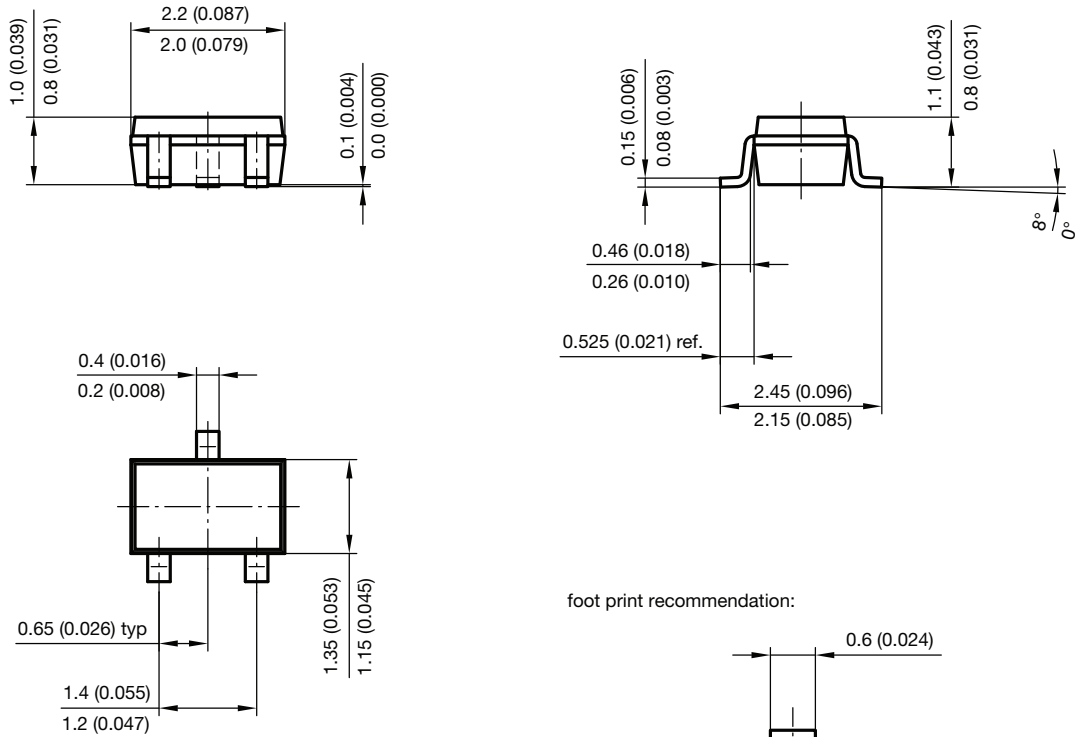

Fig. 8 - Typical Clamping Voltage  $V_{C-TLP}$  vs. Pulse Current  $I_{TLP}$

**PACKAGE DIMENSIONS** in millimeters (inches) **SOT-323**



Document no.: 6.541-5040.02-4  
 Rev. 1 - Date: 06. April 2010  
 21113

**ORIENTATION IN CARRIER TAPE SOT-323**

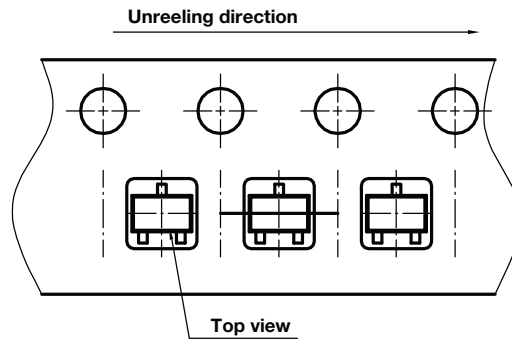

Document no.: S8-V-3717.08-002 (4)  
 Created - Date: 09. Feb. 2010  
 22761



CARRIER TAPE SOT-323

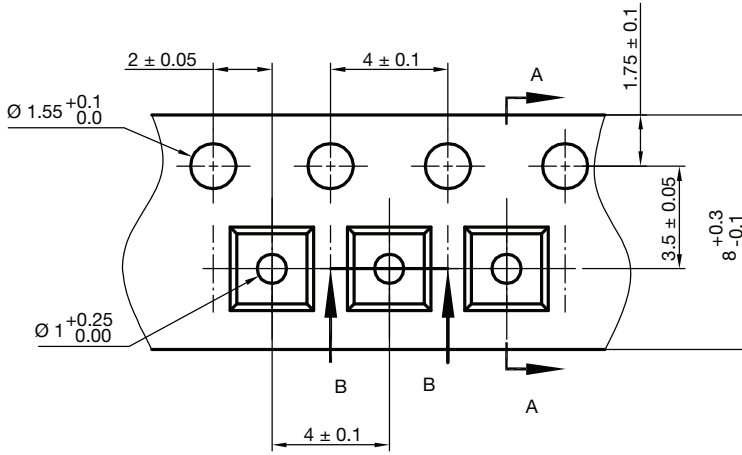

A-A Section

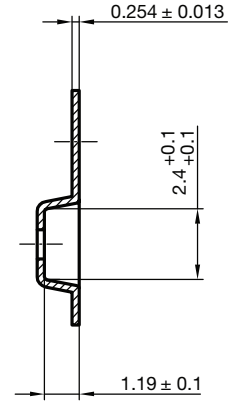

B-B Section

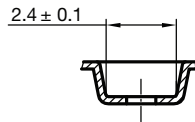

Document no.: S8-V-3717.08-002 (4)  
Created - Date: 09. Feb. 2010  
22762



## Disclaimer

ALL PRODUCT, PRODUCT SPECIFICATIONS AND DATA ARE SUBJECT TO CHANGE WITHOUT NOTICE TO IMPROVE RELIABILITY, FUNCTION OR DESIGN OR OTHERWISE.

Vishay Intertechnology, Inc., its affiliates, agents, and employees, and all persons acting on its or their behalf (collectively, "Vishay"), disclaim any and all liability for any errors, inaccuracies or incompleteness contained in any datasheet or in any other disclosure relating to any product.

Vishay makes no warranty, representation or guarantee regarding the suitability of the products for any particular purpose or the continuing production of any product. To the maximum extent permitted by applicable law, Vishay disclaims (i) any and all liability arising out of the application or use of any product, (ii) any and all liability, including without limitation special, consequential or incidental damages, and (iii) any and all implied warranties, including warranties of fitness for particular purpose, non-infringement and merchantability.

Statements regarding the suitability of products for certain types of applications are based on Vishay's knowledge of typical requirements that are often placed on Vishay products in generic applications. Such statements are not binding statements about the suitability of products for a particular application. It is the customer's responsibility to validate that a particular product with the properties described in the product specification is suitable for use in a particular application. Parameters provided in datasheets and / or specifications may vary in different applications and performance may vary over time. All operating parameters, including typical parameters, must be validated for each customer application by the customer's technical experts. Product specifications do not expand or otherwise modify Vishay's terms and conditions of purchase, including but not limited to the warranty expressed therein.

Hyperlinks included in this datasheet may direct users to third-party websites. These links are provided as a convenience and for informational purposes only. Inclusion of these hyperlinks does not constitute an endorsement or an approval by Vishay of any of the products, services or opinions of the corporation, organization or individual associated with the third-party website. Vishay disclaims any and all liability and bears no responsibility for the accuracy, legality or content of the third-party website or for that of subsequent links.

Except as expressly indicated in writing, Vishay products are not designed for use in medical, life-saving, or life-sustaining applications or for any other application in which the failure of the Vishay product could result in personal injury or death. Customers using or selling Vishay products not expressly indicated for use in such applications do so at their own risk. Please contact authorized Vishay personnel to obtain written terms and conditions regarding products designed for such applications.

No license, express or implied, by estoppel or otherwise, to any intellectual property rights is granted by this document or by any conduct of Vishay. Product names and markings noted herein may be trademarks of their respective owners.